

MJD243 (NPN), MJD253 (PNP)

Complementary Silicon Plastic Power Transistors

DPAK-3 for Surface Mount Applications

Designed for low voltage, low-power, high-gain audio amplifier applications.

Features

- High DC Current Gain
- Lead Formed for Surface Mount Applications in Plastic Sleeves (No Suffix)
- Straight Lead Version in Plastic Sleeves (“-1” Suffix)
- Low Collector-Emitter Saturation Voltage
- High Current-Gain – Bandwidth Product
- Annular Construction for Low Leakage
- Epoxy Meets UL 94 V-0 @ 0.125 in
- NJV Prefix for Automotive and Other Applications Requiring Unique Site and Control Change Requirements; AEC-Q101 Qualified and PPAP Capable
- These Devices are Pb-Free, Halogen Free/BFR Free and are RoHS Compliant

MAXIMUM RATINGS

Rating	Symbol	Value	Unit
Collector-Base Voltage	V_{CB}	100	Vdc
Collector-Emitter Voltage	V_{CEO}	100	Vdc
Emitter-Base Voltage	V_{EB}	7.0	Vdc
Collector Current – Continuous	I_C	4.0	Adc
Collector Current – Peak	I_{CM}	8.0	Adc
Base Current	I_B	1.0	Adc
Total Device Dissipation @ $T_C = 25^\circ\text{C}$ Derate above 25°C	P_D	12.5 0.1	W W/ $^\circ\text{C}$
Total Device Dissipation @ $T_A = 25^\circ\text{C}$ (Note 2) Derate above 25°C	P_D	1.4 0.011	W W/ $^\circ\text{C}$
Operating and Storage Junction Temperature Range	T_J, T_{stg}	-65 to +150	$^\circ\text{C}$
ESD – Human Body Model	HBM	3B	V
ESD – Machine Model	MM	C	V

Stresses exceeding those listed in the Maximum Ratings table may damage the device. If any of these limits are exceeded, device functionality should not be assumed, damage may occur and reliability may be affected.

1. When surface mounted on minimum pad sizes recommended.



ON Semiconductor®

www.onsemi.com

4.0 A, 100 V, 12.5 W POWER TRANSISTOR

COMPLEMENTARY

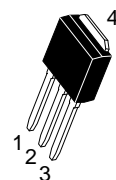
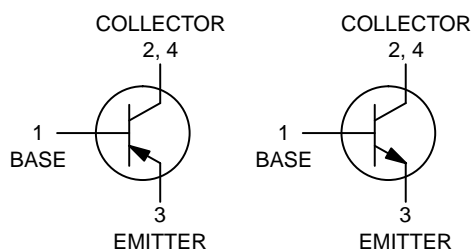

IPAK
CASE 369D
STYLE 1

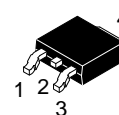

DPAK-3
CASE 369C
STYLE 1

MARKING DIAGRAMS

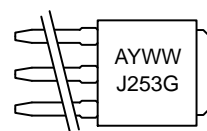

IPAK

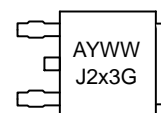

DPAK

- A = Assembly Location
- Y = Year
- WW = Work Week
- x = 4 or 5
- G = Pb-Free Package

ORDERING INFORMATION

See detailed ordering and shipping information in the package dimensions section on page 6 of this data sheet.

MJD243 (NPN), MJD253 (PNP)

THERMAL CHARACTERISTICS

Characteristic	Symbol	Value	Unit
Thermal Resistance Junction-to-Case	$R_{\theta JC}$	10	$^{\circ}C/W$
Junction-to-Ambient (Note 2)	$R_{\theta JA}$	89.3	

2. When surface mounted on minimum pad sizes recommended.

ELECTRICAL CHARACTERISTICS ($T_C = 25^{\circ}C$ unless otherwise noted)

Characteristic	Symbol	Min	Max	Unit
----------------	--------	-----	-----	------

OFF CHARACTERISTICS

Collector-Emitter Sustaining Voltage (Note 3) ($I_C = 10$ mAdc, $I_B = 0$)	$V_{CE(sus)}$	100	-	Vdc
Collector Cutoff Current ($V_{CB} = 100$ Vdc, $I_E = 0$) ($V_{CB} = 100$ Vdc, $I_E = 0$, $T_J = 125^{\circ}C$)	I_{CBO}	-	100	nAdc μ Adc
Emitter Cutoff Current ($V_{BE} = 7.0$ Vdc, $I_C = 0$)	I_{EBO}	-	100	nAdc
DC Current Gain (Note 3) ($I_C = 200$ mAdc, $V_{CE} = 1.0$ Vdc) ($I_C = 1.0$ Adc, $V_{CE} = 1.0$ Vdc)	h_{FE}	40 15	180 -	-
Collector-Emitter Saturation Voltage (Note 3) ($I_C = 500$ mAdc, $I_B = 50$ mAdc) ($I_C = 1.0$ Adc, $I_B = 100$ mAdc)	$V_{CE(sat)}$	- -	0.3 0.6	Vdc
Base-Emitter Saturation Voltage (Note 3) ($I_C = 2.0$ Adc, $I_B = 200$ mAdc)	$V_{BE(sat)}$	-	1.8	Vdc
Base-Emitter On Voltage (Note 3) ($I_C = 500$ mAdc, $V_{CE} = 1.0$ Vdc)	$V_{BE(on)}$	-	1.5	Vdc

DYNAMIC CHARACTERISTICS

Current-Gain - Bandwidth Product (Note 4) ($I_C = 100$ mAdc, $V_{CE} = 10$ Vdc, $f_{test} = 10$ MHz)	f_T	40	-	MHz
Output Capacitance ($V_{CB} = 10$ Vdc, $I_E = 0$, $f = 0.1$ MHz)	C_{ob}	-	50	pF

Product parametric performance is indicated in the Electrical Characteristics for the listed test conditions, unless otherwise noted. Product performance may not be indicated by the Electrical Characteristics if operated under different conditions.

3. Pulse Test: Pulse Width = 300 μ s, Duty Cycle \approx 2%.

4. $f_T = |h_{FE}| \cdot f_{test}$.

MJD243 (NPN), MJD253 (PNP)

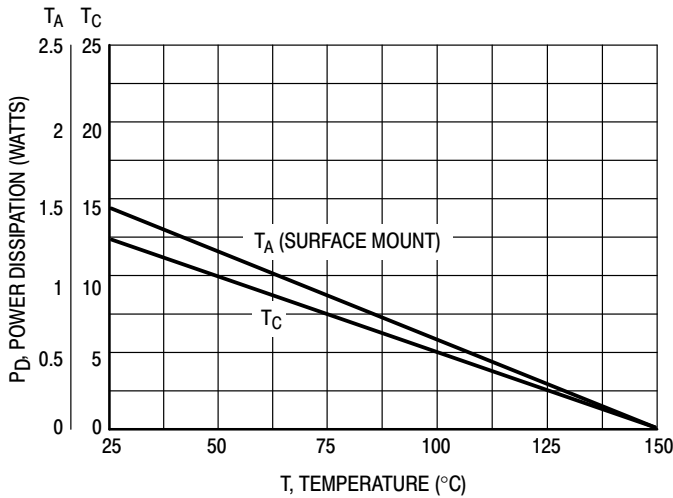

Figure 1. Power Derating

There are two limitations on the power handling ability of a transistor: average junction temperature and second breakdown. Safe operating area curves indicate $I_C - V_{CE}$ limits of the transistor that must be observed for reliable operation; i.e., the transistor must not be subjected to greater dissipation than the curves indicate.

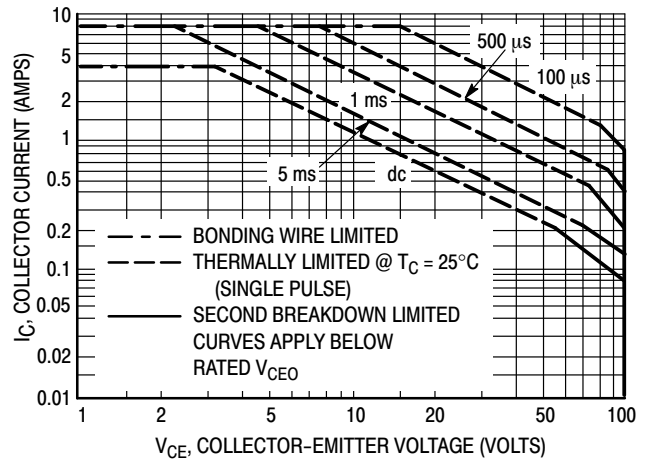

Figure 2. Active Region Maximum Safe Operating Area

The data of Figure 2 is based on $T_{J(pk)} = 150^\circ\text{C}$; T_C is variable depending on conditions. Second breakdown pulse limits are valid for duty cycles to 10% provided $T_{J(pk)} \leq 150^\circ\text{C}$. $T_{J(pk)}$ may be calculated from the data in Figure 3. At high case temperatures, thermal limitations will reduce the power that can be handled to values less than the limitations imposed by second breakdown.

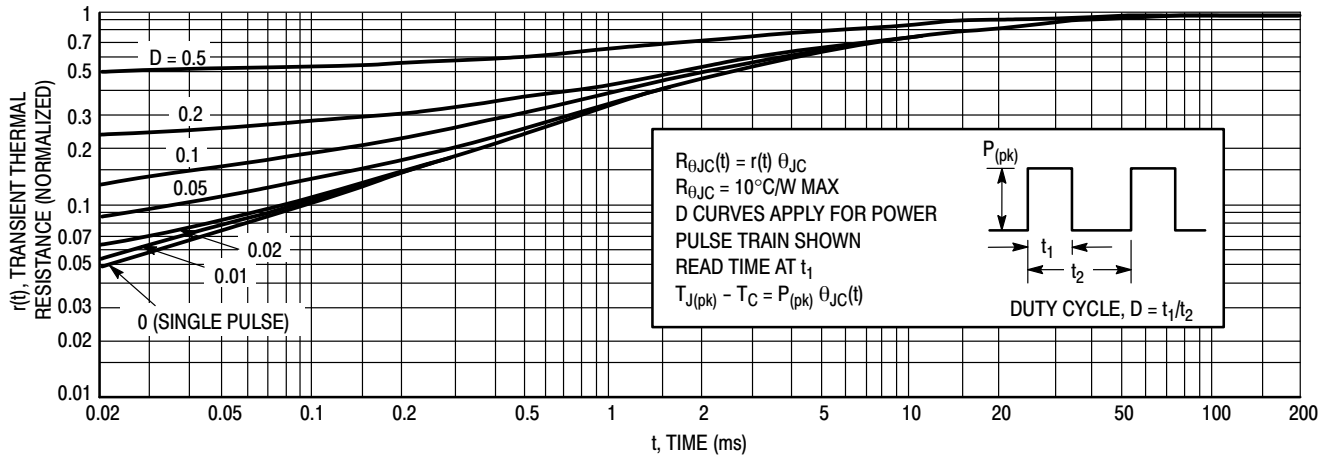
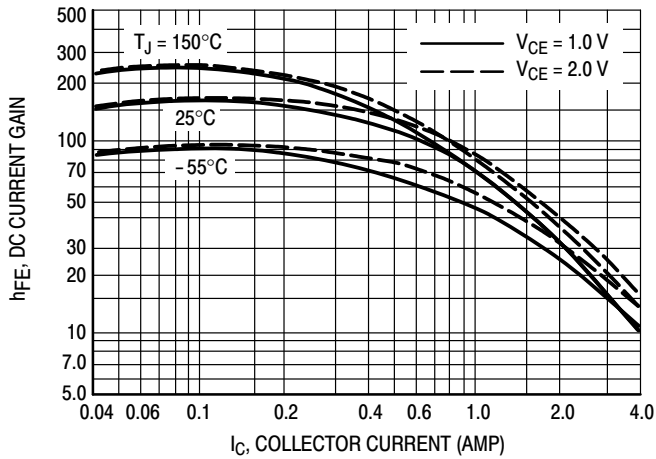

Figure 3. Thermal Response

MJD243 (NPN), MJD253 (PNP)

**NPN
MJD243**



**PNP
MJD253**

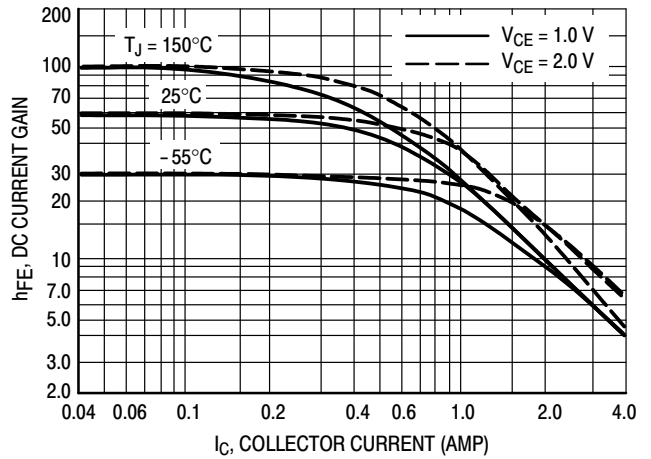

Figure 4. DC Current Gain

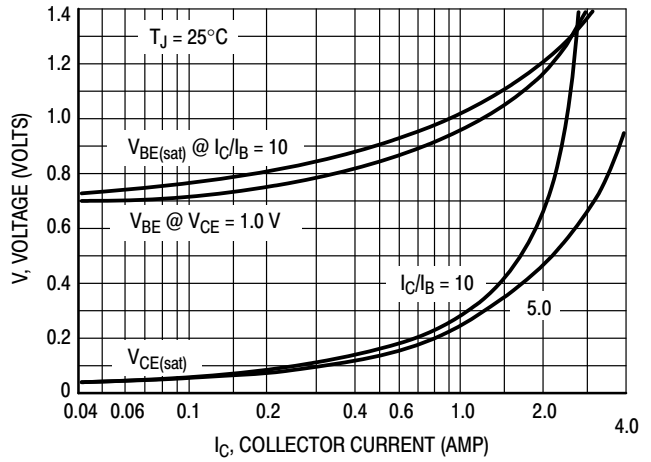
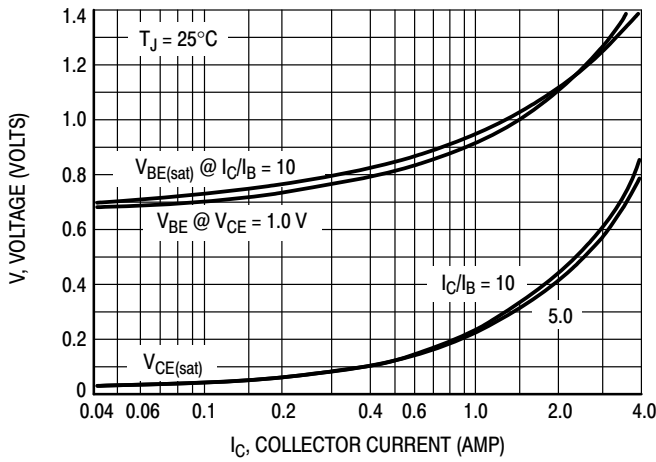

Figure 5. "On" Voltages

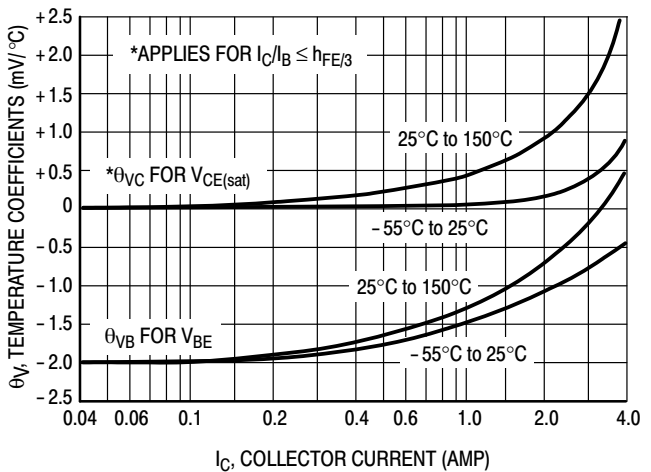
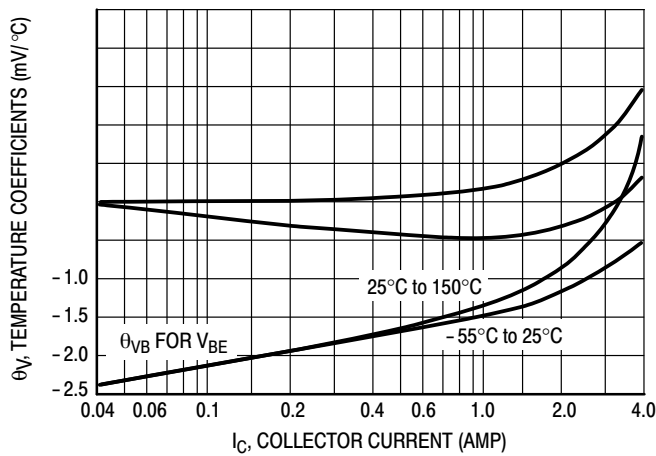

Figure 6. Temperature Coefficients

MJD243 (NPN), MJD253 (PNP)

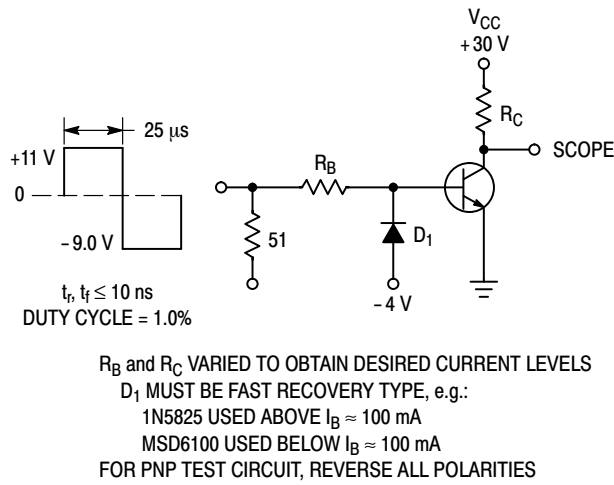

Figure 7. Switching Time Test Circuit

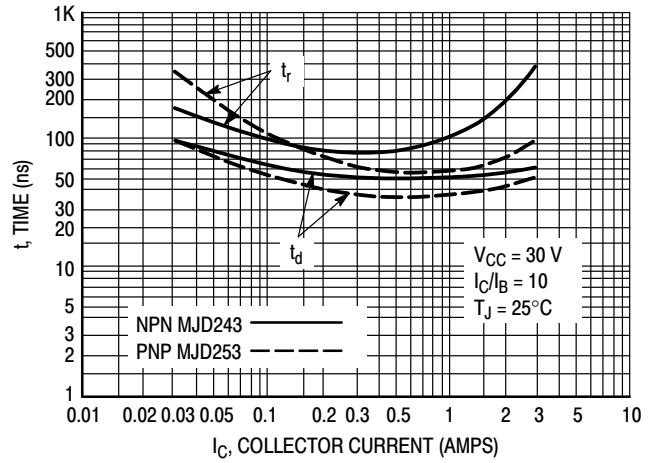

Figure 8. Turn-On Time

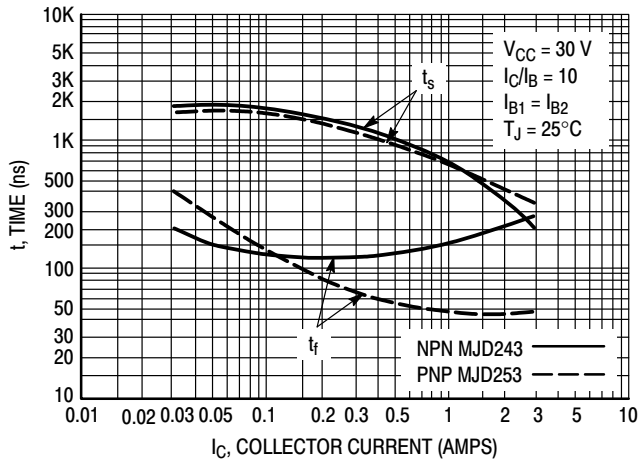

Figure 9. Turn-Off Time

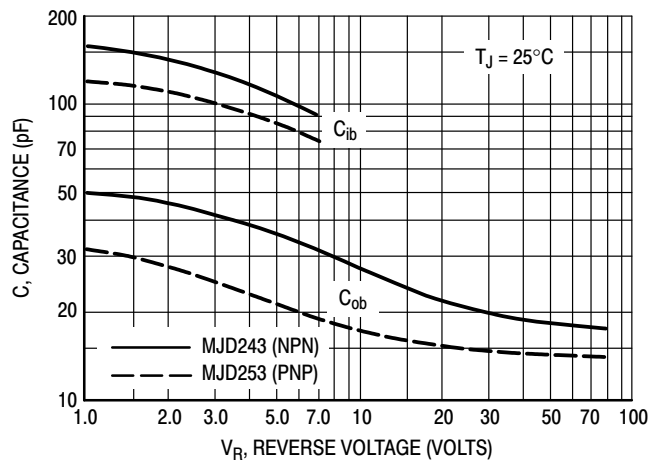

Figure 10. Capacitance

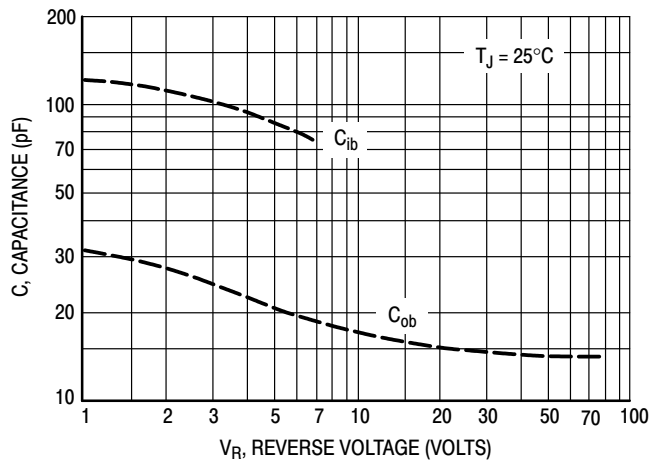

Figure 11. Capacitance

MJD243 (NPN), MJD253 (PNP)

ORDERING INFORMATION

Device	Package Type	Package	Shipping†
MJD243G	DPAK-3 (Pb-Free)	369C	75 Units / Rail
MJD243T4G	DPAK-3 (Pb-Free)	369C	2,500 / Tape & Reel
NJVMJD243T4G*	DPAK-3 (Pb-Free)	369C	2,500 / Tape & Reel
MJD253-1G	IPAK (Pb-Free)	369D	75 Units / Rail
MJD253T4G	DPAK-3 (Pb-Free)	369C	2,500 / Tape & Reel
NJVMJD253T4G*	DPAK-3 (Pb-Free)	369C	2,500 / Tape & Reel

†For information on tape and reel specifications, including part orientation and tape sizes, please refer to our Tape and Reel Packaging Specifications Brochure, BRD8011/D.

*NJV Prefix for Automotive and Other Applications Requiring Unique Site and Control Change Requirements; AEC-Q101 Qualified and PPAP Capable

MECHANICAL CASE OUTLINE

PACKAGE DIMENSIONS

ON Semiconductor®

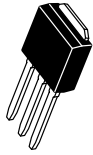

IPAK CASE 369D-01 ISSUE C

DATE 15 DEC 2010

SCALE 1:1

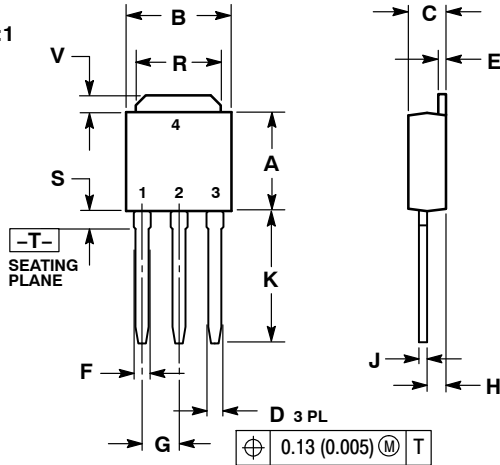

NOTES:

1. DIMENSIONING AND TOLERANCING PER ANSI Y14.5M, 1982.
2. CONTROLLING DIMENSION: INCH.

DIM	INCHES		MILLIMETERS	
	MIN	MAX	MIN	MAX
A	0.235	0.245	5.97	6.35
B	0.250	0.265	6.35	6.73
C	0.086	0.094	2.19	2.38
D	0.027	0.035	0.69	0.88
E	0.018	0.023	0.46	0.58
F	0.037	0.045	0.94	1.14
G	0.090	BSC	2.29	BSC
H	0.034	0.040	0.87	1.01
J	0.018	0.023	0.46	0.58
K	0.350	0.380	8.89	9.65
R	0.180	0.215	4.45	5.45
S	0.025	0.040	0.63	1.01
V	0.035	0.050	0.89	1.27
Z	0.155	---	3.93	---

MARKING DIAGRAMS

- | | | | |
|--|---|--|--|
| <p>STYLE 1:
PIN 1. BASE
2. COLLECTOR
3. EMITTER
4. COLLECTOR</p> | <p>STYLE 2:
PIN 1. GATE
2. DRAIN
3. SOURCE
4. DRAIN</p> | <p>STYLE 3:
PIN 1. ANODE
2. CATHODE
3. ANODE
4. CATHODE</p> | <p>STYLE 4:
PIN 1. CATHODE
2. ANODE
3. GATE
4. ANODE</p> |
| <p>STYLE 5:
PIN 1. GATE
2. ANODE
3. CATHODE
4. ANODE</p> | <p>STYLE 6:
PIN 1. MT1
2. MT2
3. GATE
4. MT2</p> | <p>STYLE 7:
PIN 1. GATE
2. COLLECTOR
3. EMITTER
4. COLLECTOR</p> | |

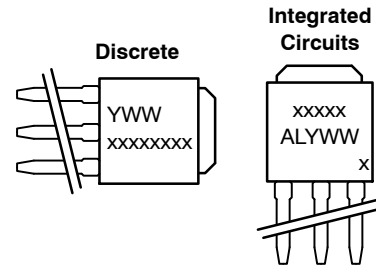

- xxxxxxx = Device Code
A = Assembly Location
IL = Wafer Lot
Y = Year
WW = Work Week

DOCUMENT NUMBER:	98AON10528D	Electronic versions are uncontrolled except when accessed directly from the Document Repository. Printed versions are uncontrolled except when stamped "CONTROLLED COPY" in red.
DESCRIPTION:	IPAK (DPAK INSERTION MOUNT)	PAGE 1 OF 1

ON Semiconductor and are trademarks of Semiconductor Components Industries, LLC dba ON Semiconductor or its subsidiaries in the United States and/or other countries. ON Semiconductor reserves the right to make changes without further notice to any products herein. ON Semiconductor makes no warranty, representation or guarantee regarding the suitability of its products for any particular purpose, nor does ON Semiconductor assume any liability arising out of the application or use of any product or circuit, and specifically disclaims any and all liability, including without limitation special, consequential or incidental damages. ON Semiconductor does not convey any license under its patent rights nor the rights of others.

MECHANICAL CASE OUTLINE PACKAGE DIMENSIONS

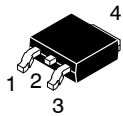

DPAK (SINGLE GAUGE) CASE 369C ISSUE G

DATE 31 MAY 2023

SCALE 1:1

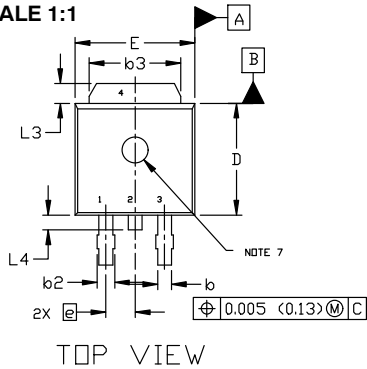

TOP VIEW

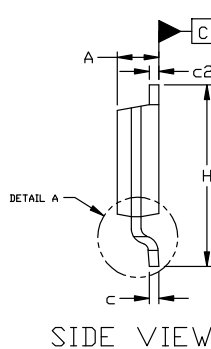

SIDE VIEW

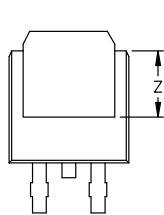

BOTTOM VIEW

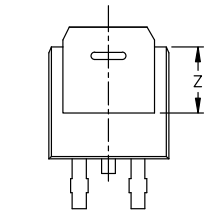
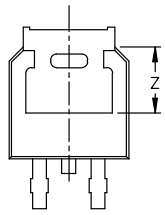

BOTTOM VIEW

ALTERNATE CONSTRUCTIONS

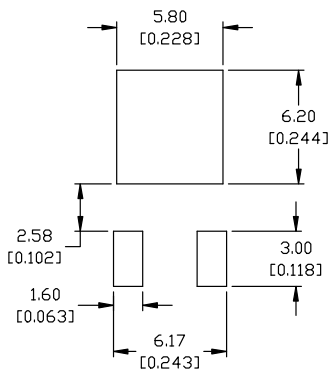

RECOMMENDED MOUNTING FOOTPRINT*

*FOR ADDITIONAL INFORMATION ON OUR Pb-FREE STRATEGY AND SOLDERING DETAILS, PLEASE DOWNLOAD THE ON SEMICONDUCTOR SOLDERING AND MOUNTING TECHNIQUES REFERENCE MANUAL, SOLDERRM/D.

- | | | | | |
|--|--|---|---|--|
| STYLE 1:
PIN 1. BASE
2. COLLECTOR
3. EMITTER
4. COLLECTOR | STYLE 2:
PIN 1. GATE
2. DRAIN
3. SOURCE
4. DRAIN | STYLE 3:
PIN 1. ANODE
2. CATHODE
3. ANODE
4. CATHODE | STYLE 4:
PIN 1. CATHODE
2. ANODE
3. GATE
4. ANODE | STYLE 5:
PIN 1. GATE
2. ANODE
3. CATHODE
4. ANODE |
| STYLE 6:
PIN 1. MT1
2. MT2
3. GATE
4. MT2 | STYLE 7:
PIN 1. GATE
2. COLLECTOR
3. EMITTER
4. COLLECTOR | STYLE 8:
PIN 1. N/C
2. CATHODE
3. ANODE
4. CATHODE | STYLE 9:
PIN 1. ANODE
2. CATHODE
3. RESISTOR ADJUST
4. CATHODE | STYLE 10:
PIN 1. CATHODE
2. ANODE
3. CATHODE
4. ANODE |

NOTES:

- DIMENSIONING AND TOLERANCING ASME Y14.5M, 1994.
- CONTROLLING DIMENSION: INCHES
- THERMAL PAD CONTOUR OPTIONAL WITHIN DIMENSIONS b3, L3, AND Z.
- DIMENSIONS D AND E DO NOT INCLUDE MOLD FLASH, PROTRUSIONS, OR BURRS. MOLD FLASH, PROTRUSIONS, OR GATE BURRS SHALL NOT EXCEED 0.006 INCHES PER SIDE.
- DIMENSIONS D AND E ARE DETERMINED AT THE OUTERMOST EXTREMES OF THE PLASTIC BODY.
- DATUMS A AND B ARE DETERMINED AT DATUM PLANE H.
- OPTIONAL MOLD FEATURE.

DIM	INCHES		MILLIMETERS	
	MIN.	MAX.	MIN.	MAX.
A	0.086	0.094	2.18	2.38
A1	0.000	0.005	0.00	0.13
b	0.025	0.035	0.63	0.89
b2	0.028	0.045	0.72	1.14
b3	0.180	0.215	4.57	5.46
c	0.018	0.024	0.46	0.61
c2	0.018	0.024	0.46	0.61
D	0.235	0.245	5.97	6.22
E	0.250	0.265	6.35	6.73
e	0.090	BSC	2.29	BSC
H	0.370	0.410	9.40	10.41
L	0.055	0.070	1.40	1.78
L1	0.114	REF	2.90	REF
L2	0.020	BSC	0.51	BSC
L3	0.035	0.050	0.89	1.27
L4	----	0.040	---	1.01
Z	0.155	----	3.93	---

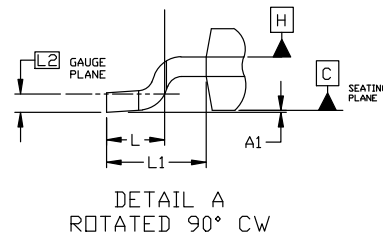

DETAIL A
ROTATED 90° CW

GENERIC MARKING DIAGRAM*

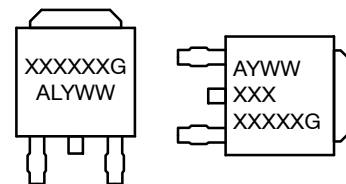

- IC**
 XXXXXX = Device Code
 A = Assembly Location
 L = Wafer Lot
 Y = Year
 WW = Work Week
 G = Pb-Free Package
- Discrete**
 AYWW
 XXX
 XXXXXG

*This information is generic. Please refer to device data sheet for actual part marking. Pb-Free indicator, "G" or microdot "•", may or may not be present. Some products may not follow the Generic Marking.

DOCUMENT NUMBER:	98AON10527D	Electronic versions are uncontrolled except when accessed directly from the Document Repository. Printed versions are uncontrolled except when stamped "CONTROLLED COPY" in red.
DESCRIPTION:	DPAK (SINGLE GAUGE)	PAGE 1 OF 1

onsemi and onsemi are trademarks of Semiconductor Components Industries, LLC dba onsemi or its subsidiaries in the United States and/or other countries. onsemi reserves the right to make changes without further notice to any products herein. onsemi makes no warranty, representation or guarantee regarding the suitability of its products for any particular purpose, nor does onsemi assume any liability arising out of the application or use of any product or circuit, and specifically disclaims any and all liability, including without limitation special, consequential or incidental damages. onsemi does not convey any license under its patent rights nor the rights of others.

onsemi, **Onsemi**, and other names, marks, and brands are registered and/or common law trademarks of Semiconductor Components Industries, LLC dba "**onsemi**" or its affiliates and/or subsidiaries in the United States and/or other countries. **onsemi** owns the rights to a number of patents, trademarks, copyrights, trade secrets, and other intellectual property. A listing of **onsemi**'s product/patent coverage may be accessed at www.onsemi.com/site/pdf/Patent-Marking.pdf. **onsemi** reserves the right to make changes at any time to any products or information herein, without notice. The information herein is provided "as-is" and **onsemi** makes no warranty, representation or guarantee regarding the accuracy of the information, product features, availability, functionality, or suitability of its products for any particular purpose, nor does **onsemi** assume any liability arising out of the application or use of any product or circuit, and specifically disclaims any and all liability, including without limitation special, consequential or incidental damages. Buyer is responsible for its products and applications using **onsemi** products, including compliance with all laws, regulations and safety requirements or standards, regardless of any support or applications information provided by **onsemi**. "Typical" parameters which may be provided in **onsemi** data sheets and/or specifications can and do vary in different applications and actual performance may vary over time. All operating parameters, including "Typicals" must be validated for each customer application by customer's technical experts. **onsemi** does not convey any license under any of its intellectual property rights nor the rights of others. **onsemi** products are not designed, intended, or authorized for use as a critical component in life support systems or any FDA Class 3 medical devices or medical devices with a same or similar classification in a foreign jurisdiction or any devices intended for implantation in the human body. Should Buyer purchase or use **onsemi** products for any such unintended or unauthorized application, Buyer shall indemnify and hold **onsemi** and its officers, employees, subsidiaries, affiliates, and distributors harmless against all claims, costs, damages, and expenses, and reasonable attorney fees arising out of, directly or indirectly, any claim of personal injury or death associated with such unintended or unauthorized use, even if such claim alleges that **onsemi** was negligent regarding the design or manufacture of the part. **onsemi** is an Equal Opportunity/Affirmative Action Employer. This literature is subject to all applicable copyright laws and is not for resale in any manner.

ADDITIONAL INFORMATION

TECHNICAL PUBLICATIONS:

Technical Library: www.onsemi.com/design/resources/technical-documentation
onsemi Website: www.onsemi.com

ONLINE SUPPORT: www.onsemi.com/support

For additional information, please contact your local Sales Representative at www.onsemi.com/support/sales

Looking for pricing, stock, or lifecycle information?

Click below to explore more details on WIN SOURCE:

 [View NJVMJD243T4G](#) on WIN SOURCE

 [ON Semiconductor](#) Information

Optimize Your Supply Chain with WIN SOURCE Solutions

-  Global Sourcing Solution
-  Obsolete Management
-  Cost Control Management
-  Shortage Management
-  Alternative Solution
-  Excess Inventory Management