



**THE DATASHEET OF  
NSVDAN222T1G**



# DAN222, NSVDAN222

## Common Cathode Silicon Dual Switching Diode

This Common Cathode Silicon Epitaxial Planar Dual Diode is designed for use in ultra high speed switching applications. This device is housed in the SOT-416/SC-75 package which is designed for low power surface mount applications, where board space is at a premium.

### Features

- Fast  $t_{rr}$
- Low  $C_D$
- NSV Prefix for Automotive and Other Applications Requiring Unique Site and Control Change Requirements; AEC-Q101 Qualified and PPAP Capable
- These Devices are Pb-Free, Halogen Free/BFR Free and are RoHS Compliant

### MAXIMUM RATINGS ( $T_A = 25^\circ\text{C}$ )

Rating	Symbol	Value	Unit
Reverse Voltage	$V_R$	80	Vdc
Peak Reverse Voltage	$V_{RM}$	80	Vdc
Forward Current	$I_F$	100	mAdc
Peak Forward Current	$I_{FM}$	300	mAdc
Peak Forward Surge Current (Note 1)	$I_{FSM}$	2.0	Adc

### THERMAL CHARACTERISTICS

Characteristic	Symbol	Max	Unit
Power Dissipation	$P_D$	150	mW
Junction Temperature	$T_J$	150	$^\circ\text{C/W}$
Storage Temperature Range	$T_{stg}$	-55 to +150	$^\circ\text{C}$

Stresses exceeding Maximum Ratings may damage the device. Maximum Ratings are stress ratings only. Functional operation above the Recommended Operating Conditions is not implied. Extended exposure to stresses above the Recommended Operating Conditions may affect device reliability.

1.  $t = 1 \mu\text{s}$



ON Semiconductor®

<http://onsemi.com>

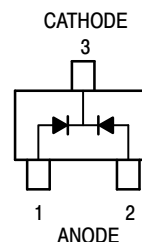

SC-75/SOT-416  
CASE 463  
STYLE 3

### MARKING DIAGRAM

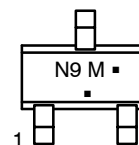

N9 = Specific Device Code  
M = Date Code\*  
▪ = Pb-Free Package

(Note: Microdot may be in either location)  
\*Date Code orientation may vary depending upon manufacturing location.

### ORDERING INFORMATION

Device	Package	Shipping†
DAN222G	SC-75 (Pb-Free)	3000 / Tape & Reel
DAN222T1G	SC-75 (Pb-Free)	3000 / Tape & Reel
NSVDAN222T1G	SC-75 (Pb-Free)	3000 / Tape & Reel

†For information on tape and reel specifications, including part orientation and tape sizes, please refer to our Tape and Reel Packaging Specifications Brochure, BRD8011/D.

# DAN222, NSVDAN222

## ELECTRICAL CHARACTERISTICS ( $T_A = 25^\circ\text{C}$ )

Characteristic	Symbol	Condition	Min	Max	Unit
Reverse Voltage Leakage Current	$I_R$	$V_R = 70\text{ V}$	-	0.1	$\mu\text{A}$
Forward Voltage	$V_F$	$I_F = 100\text{ mA}$	-	1.2	Vdc
Reverse Breakdown Voltage	$V_R$	$I_R = 100\ \mu\text{A}$	80	-	Vdc
Diode Capacitance	$C_D$	$V_R = 6.0\text{ V}, f = 1.0\text{ MHz}$	-	3.5	pF
Reverse Recovery Time	$t_{rr}$ (Note 2)	$I_F = 5.0\text{ mA}, V_R = 6.0\text{ V}, R_L = 100\ \Omega, I_{rr} = 0.1\ I_R$	-	4.0	ns

2.  $t_{rr}$  Test Circuit on following page.

## TYPICAL ELECTRICAL CHARACTERISTICS

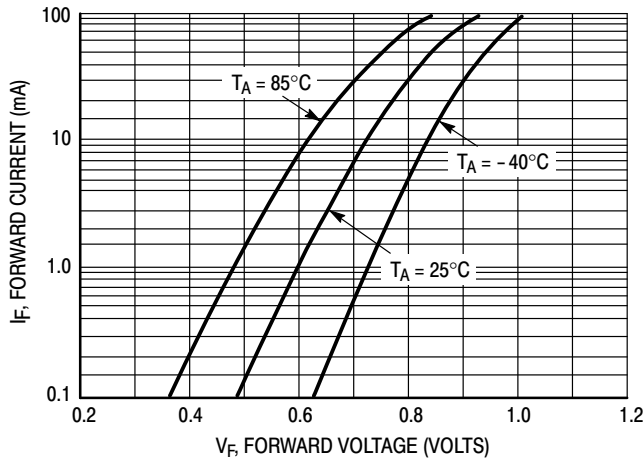

Figure 1. Forward Voltage

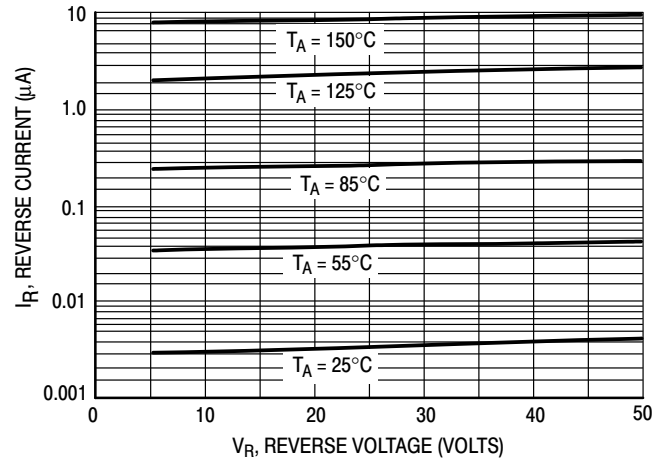

Figure 2. Reverse Current

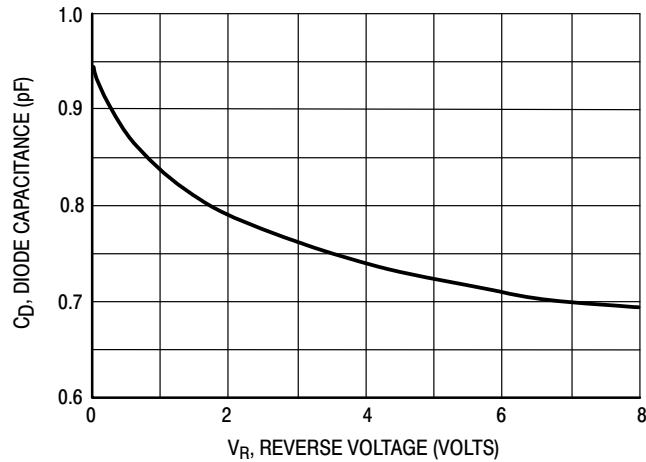
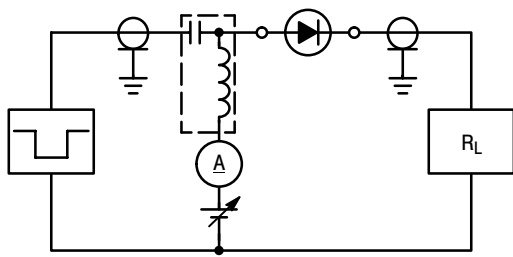
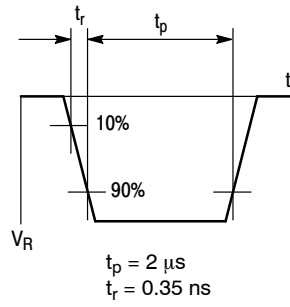

Figure 3. Diode Capacitance

# DAN222, NSVDAN222



RECOVERY TIME EQUIVALENT TEST CIRCUIT



INPUT PULSE

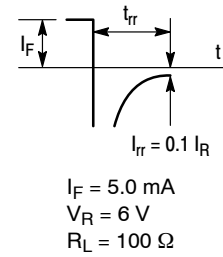

OUTPUT PULSE

Figure 4. Reverse Recovery Time Test Circuit for the DAN222

# MECHANICAL CASE OUTLINE

## PACKAGE DIMENSIONS



**SC75-3 1.60x0.80x0.80, 1.00P**  
**CASE 463**  
**ISSUE H**

DATE 01 FEB 2024

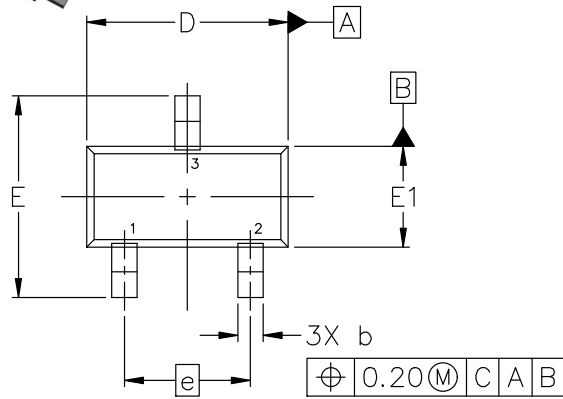

TOP VIEW

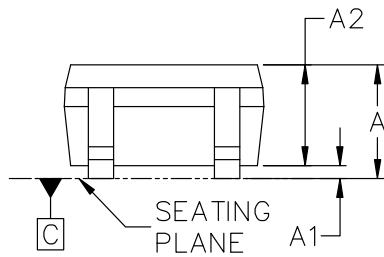

SIDE VIEW

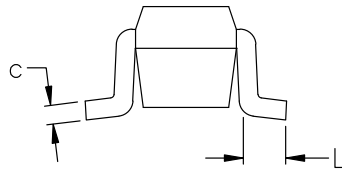

END VIEW

**GENERIC MARKING DIAGRAM\***

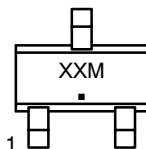

- XX = Specific Device Code
- M = Date Code
- = Pb-Free Package

\*This information is generic. Please refer to device data sheet for actual part marking. Pb-Free indicator, "G" or microdot "▪", may or may not be present. Some products may not follow the Generic Marking.

- STYLE 1:  
PIN 1. BASE  
2. EMITTER  
3. COLLECTOR
- STYLE 2:  
PIN 1. ANODE  
2. N/C  
3. CATHODE
- STYLE 3:  
PIN 1. ANODE  
2. ANODE  
3. CATHODE
- STYLE 4:  
PIN 1. CATHODE  
2. CATHODE  
3. ANODE
- STYLE 5:  
PIN 1. GATE  
2. SOURCE  
3. DRAIN

NOTES:

- DIMENSIONING AND TOLERANCING CONFORM TO ASME Y14.5-2018.
- ALL DIMENSION ARE IN MILLIMETERS.

DIM	MILLIMETERS		
	MIN.	NOM.	MAX.
A	0.70	0.80	0.90
A1	0.00	0.05	0.10
A2	0.80 REF.		
b	0.15	0.20	0.30
c	0.10	0.15	0.25
D	1.55	1.60	1.65
E	1.50	1.60	1.70
E1	0.70	0.80	0.90
e	1.00 BSC		
L	0.10	0.15	0.20

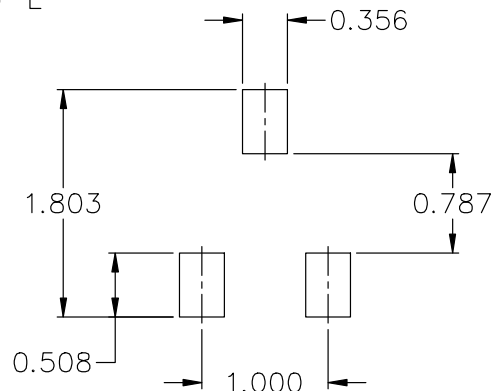

RECOMMENDED MOUNTING FOOTPRINT\*

\* FOR ADDITIONAL INFORMATION ON OUR Pb-FREE STRATEGY AND SOLDERING DETAILS, PLEASE DOWNLOAD THE ON SEMICONDUCTOR SOLDERING AND MOUNTING TECHNIQUES REFERENCE MANUAL, SOLDERRM/D.

<b>DOCUMENT NUMBER:</b>	<b>98ASB15184C</b>	Electronic versions are uncontrolled except when accessed directly from the Document Repository. Printed versions are uncontrolled except when stamped "CONTROLLED COPY" in red.
<b>DESCRIPTION:</b>	<b>SC75-3 1.60x0.80x0.80, 1.00P</b>	<b>PAGE 1 OF 1</b>

onsemi and ONSEMI are trademarks of Semiconductor Components Industries, LLC dba onsemi or its subsidiaries in the United States and/or other countries. onsemi reserves the right to make changes without further notice to any products herein. onsemi makes no warranty, representation or guarantee regarding the suitability of its products for any particular purpose, nor does onsemi assume any liability arising out of the application or use of any product or circuit, and specifically disclaims any and all liability, including without limitation special, consequential or incidental damages. onsemi does not convey any license under its patent rights nor the rights of others.

**onsemi**, **Onsemi**, and other names, marks, and brands are registered and/or common law trademarks of Semiconductor Components Industries, LLC dba "**onsemi**" or its affiliates and/or subsidiaries in the United States and/or other countries. **onsemi** owns the rights to a number of patents, trademarks, copyrights, trade secrets, and other intellectual property. A listing of **onsemi**'s product/patent coverage may be accessed at [www.onsemi.com/site/pdf/Patent-Marking.pdf](http://www.onsemi.com/site/pdf/Patent-Marking.pdf). **onsemi** reserves the right to make changes at any time to any products or information herein, without notice. The information herein is provided "as-is" and **onsemi** makes no warranty, representation or guarantee regarding the accuracy of the information, product features, availability, functionality, or suitability of its products for any particular purpose, nor does **onsemi** assume any liability arising out of the application or use of any product or circuit, and specifically disclaims any and all liability, including without limitation special, consequential or incidental damages. Buyer is responsible for its products and applications using **onsemi** products, including compliance with all laws, regulations and safety requirements or standards, regardless of any support or applications information provided by **onsemi**. "Typical" parameters which may be provided in **onsemi** data sheets and/or specifications can and do vary in different applications and actual performance may vary over time. All operating parameters, including "Typicals" must be validated for each customer application by customer's technical experts. **onsemi** does not convey any license under any of its intellectual property rights nor the rights of others. **onsemi** products are not designed, intended, or authorized for use as a critical component in life support systems or any FDA Class 3 medical devices or medical devices with a same or similar classification in a foreign jurisdiction or any devices intended for implantation in the human body. Should Buyer purchase or use **onsemi** products for any such unintended or unauthorized application, Buyer shall indemnify and hold **onsemi** and its officers, employees, subsidiaries, affiliates, and distributors harmless against all claims, costs, damages, and expenses, and reasonable attorney fees arising out of, directly or indirectly, any claim of personal injury or death associated with such unintended or unauthorized use, even if such claim alleges that **onsemi** was negligent regarding the design or manufacture of the part. **onsemi** is an Equal Opportunity/Affirmative Action Employer. This literature is subject to all applicable copyright laws and is not for resale in any manner.

---

## ADDITIONAL INFORMATION

### TECHNICAL PUBLICATIONS:

Technical Library: [www.onsemi.com/design/resources/technical-documentation](http://www.onsemi.com/design/resources/technical-documentation)  
onsemi Website: [www.onsemi.com](http://www.onsemi.com)

### ONLINE SUPPORT: [www.onsemi.com/support](http://www.onsemi.com/support)

For additional information, please contact your local Sales Representative at [www.onsemi.com/support/sales](http://www.onsemi.com/support/sales)

## Looking for pricing, stock, or lifecycle information?

Click below to explore more details on WIN SOURCE:

 [View NSVDAN222T1G on WIN SOURCE](#)

 [ON Semiconductor](#) Information

## Optimize Your Supply Chain with WIN SOURCE Solutions

-  Global Sourcing Solution
-  Obsolete Management
-  Cost Control Management
-  Shortage Management
-  Alternative Solution
-  Excess Inventory Management