



**THE DATASHEET OF
PAM3101BAB330**



Description

The PAM3101 series of positive voltage linear regulators feature low quiescent current (65µA typ.) and low dropout voltage, making them ideal for battery powered applications. Their high PSRR make them useful in applications where AC noise on the input power supply must be suppressed. Space-saving SOT-23, SOT-89, SC70 and DFN1.6x1.6-6L packages are attractive for portable and handheld applications. They have both thermal shutdown and current limit features to prevent device failure from extreme operating conditions. They are stable with an output capacitor of 2.2µF or greater.

Features

- Low Dropout Voltage: 180mV@300mA ($V_O = 3.3V$)
- Output Voltage Accuracy within $\pm 2\%$
- Supply Voltage Range: 2.5V to 5.5V
- Quiescent Current: 65µA typ.
- High PSRR: 70dB@1kHz
- Excellent Line and Regulation
- Fast Discharge
- Current Limiting
- Short Circuit Protection
- Low Temperature Coefficient
- Shutdown Current: 0.5µA
- Thermal Shutdown
- Space Saving Packages: SOT-23, SOT-89, SC70 and DFN1.6x1.6
- Pb-Free Packages

Applications

- Cellular Phones
- Bluetooth Earphones
- Digital Cameras
- Portable Electronics
- WLANs
- MP3 Players

Pin Assignments

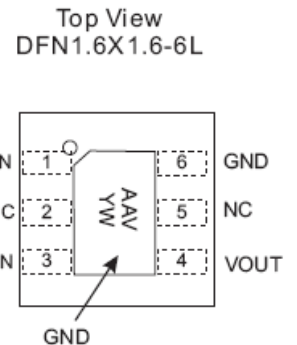
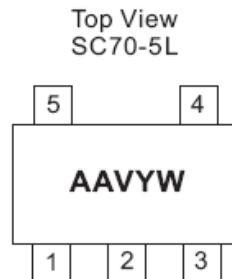
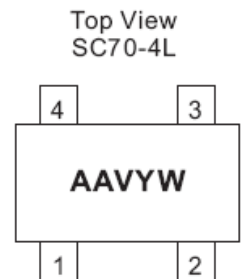
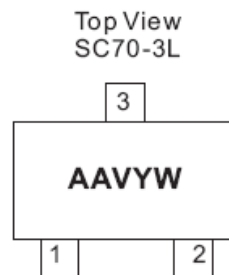
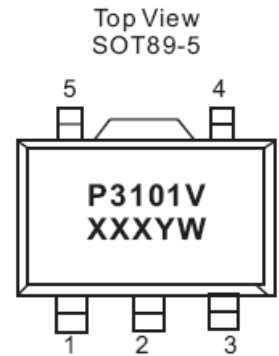
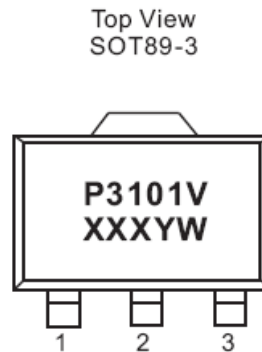
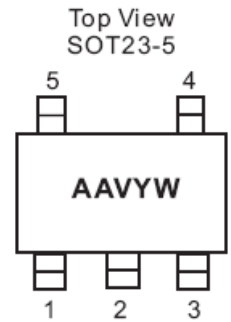
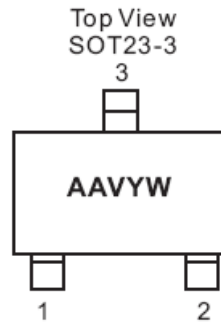

Typical Applications Circuit

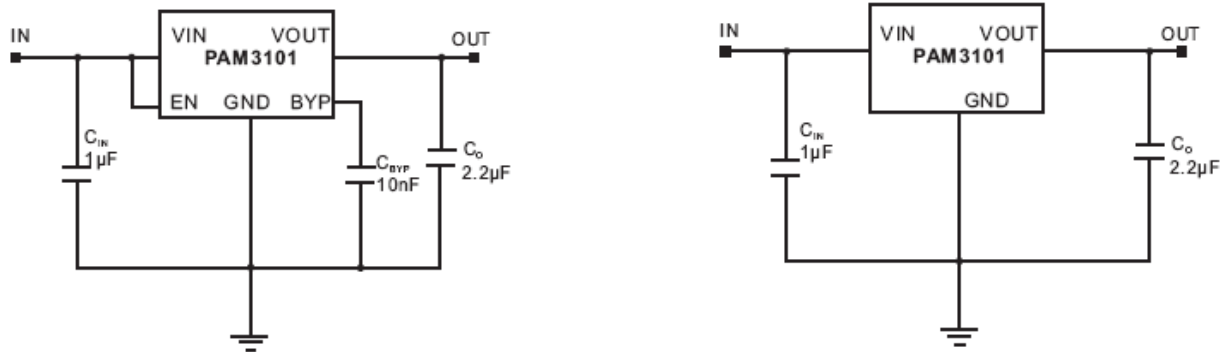

Pin Configuration and Description

Package Type	Pin Number					
	1	2	3	4	5	6
SOT23-3	GND	VOUT	VIN	—	—	—
	VIN	VOUT	GND	—	—	—
	VOUT	GND	VIN	—	—	—
SOT23-5	VIN	GND	EN	BYP	VOUT	—
	VIN	GND	EN	NC	VOUT	—
SOT89-3	GND	VIN	VOUT	—	—	—
	VOUT	GND	VIN	—	—	—
SOT89-5	VOUT	GND	NC	EN	VIN	—
SC-70-3L	VIN	VOUT	GND	—	—	—
SC70-4L	EN	GND	VOUT	VIN	—	—
SC70-5L	VIN	GND	EN	BYP	VOUT	—
DFN1.6x1.6-6L	EN	NC	VIN	VOUT	NC	GND

Pin Name	Function
VIN	Input
GND	Ground
VOUT	Output
EN	Chip Enable (active high) PAM3101BABXX---EN default floating Other part no---EN default pull high
BYP	Bypass Pin, need a 10nF capacitor connect to GND
NC	No Connection

Functional Block Diagram



Absolute Maximum Ratings (@T_A = +25°C, unless otherwise specified.)

These are stress ratings only and functional operation is not implied. Exposure to absolute maximum ratings for prolonged time periods may affect device reliability. All voltages are with respect to ground.

Parameter	Rating	Unit
Input Voltage	6.0	V
Output Current	300	mA
Output Pin Voltage	GND -0.3 to V _{IN} +0.3V	V
Lead Soldering Temperature	300, (5sec)	°C
Storage Temperature	-65 to +150	°C
ESD Rating	Class B	—

Recommended Operating Conditions (@T_A = +25°C, unless otherwise specified.)

Parameter	Rating	Unit
Supply Voltage Range	2.5 to 5.5	V
Junction Temperature	-40 to +125	°C
Operation Temperature	-40 to +85	

Thermal Information

Parameter	Symbol	Package	Max	Unit
Thermal Resistance Junction to Case)	θ_{JC}	SOT23	130	°C/W
		SOT-89	100	
		SC70	160	
		DFN1.6x1.6	65	
Thermal Resistance (Junction to Ambient)	θ_{JA}	SOT23	250	
		SOT-89	180	
		SC70	300	
		DFN1.6x1.6	175	
Internal Power Dissipation (@ $T_A = +25^\circ\text{C}$)	P_D	SOT23	400	mW
		SOT-89	550	
		SC70	300	
		DFN1.6x1.6	570	

Electrical Characteristics (@ $T_A = +25^\circ\text{C}$, $V_{CE1} = V_{CE2} = V_{IN} = V_O + 1\text{V}$, $C_{IN} = 2.2\mu\text{F}$, $C_O = 2.2\mu\text{F}$, unless otherwise specified.)

Parameter	Symbol	Test Conditions	Min	Typ	Max	Units	
Input Voltage	V_{IN}	—	Note 1	—	5.5	V	
Output Voltage	V_O	$I_O = 1\text{mA}$	-2	—	+2	%	
Output Current	I_O	—	300	—	Note 2	mA	
Dropout Voltage	V_{DROP}	$I_O = 300\text{mA}$	$V_O = 1.5\text{V}$	—	1150	1400	mV
			$V_O = 1.8\text{V}$	—	850	1100	
			$2.5\text{V} \leq V_O < 3.3\text{V}$	—	370	450	
			$V_O \geq 3.3\text{V}$	—	180	230	
Ground Current	I_{GND}	$I_O = 1\text{mA}$ to 300mA	—	70	90	μA	
Quiescent Current	I_Q	$I_O = 0\text{mA}$	—	65	90	μA	
Line Regulation	LNR	$I_O = 1\text{mA}$, $V_O < 2\text{V}$, $V_{IN} = 2.8\text{V}$ to 3.8V	-0.15	0.10	0.15	%V	
		$I_O = 1\text{mA}$, $2\text{V} \leq V_O < 3.3\text{V}$, $V_{IN} = V_O + 0.5\text{V}$ to $V_O + 1\text{V}$	-0.10	0.03	0.10		
		$I_O = 1\text{mA}$, $V_O \geq 3.3\text{V}$, $V_{IN} = V_O + 0.5\text{V}$ to $V_O + 1\text{V}$	-0.4	0.2	0.4		
Load Regulation	LDR	$I_O = 1\text{mA}$ to 300mA , $V_O \geq 2\text{V}$	-2	1	+2	%	
		$I_O = 1\text{mA}$ to 300mA , $V_O < 2\text{V}$	—	30	60	mV	
Temperature Coefficient	T_C	$I_O = 1\text{mA}$	—	40	—	ppm/°C	
Over Temperature Shutdown	OTS	$I_O = 1\text{mA}$	—	150	—	°C	
Over Temperature Hysteresis	OTH	$I_O = 1\text{mA}$	—	30	—	°C	
Power Supply Ripple Rejection	PSRR	$I_O = 100\text{mA}$ $C_{BYP} = 10\text{nF}$ $V_O = 3.3\text{V}$	$f = 100\text{Hz}$	—	70	—	dB
			$f = 1\text{kHz}$	—	65	—	
Output Noise	V_N	$f = 10\text{Hz}$ to 100kHz , $C_{BYP} = 10\text{nF}$	—	50	—	μVRMS	
CE Input High Threshold	V_{TH}	$V_{IN} = 2.5\text{V}$ to 5V	1.5	—	—	V	
CE Input Low Threshold	V_{TL}	$V_{IN} = 2.5\text{V}$ to 5V	—	—	0.3	V	
Shutdown Current	I_{SD}	$V_{EN} = 0\text{V}$	—	0.01	1	μA	

Notes: 1. The minimum input voltage ($V_{IN(MIN)}$) of the PAM3101 is determined by output voltage and dropout voltage. The minimum input voltage is defined as:
 $V_{IN(MIN)} = V_O + V_{DROP}$
 2. Output current is limited by P_D , maximum $I_O = P_D / (V_{IN(MAX)} - V_O)$.

Typical Performance Characteristics

(@T_A = +25°C, V_{EN} = V_{IN}, C_{IN} = 1μF, C_O = 2.2μF, C_{BYP} = 10nF unless otherwise specified.)

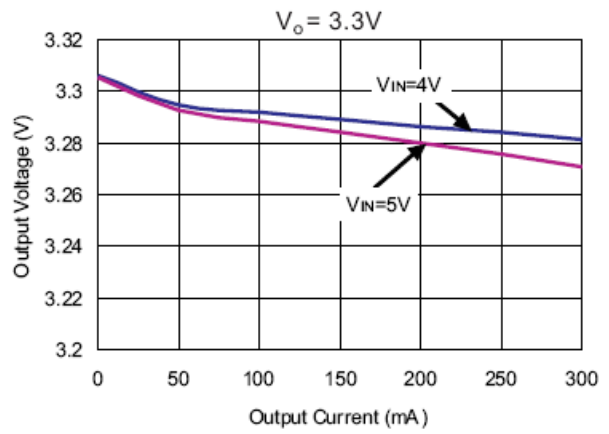
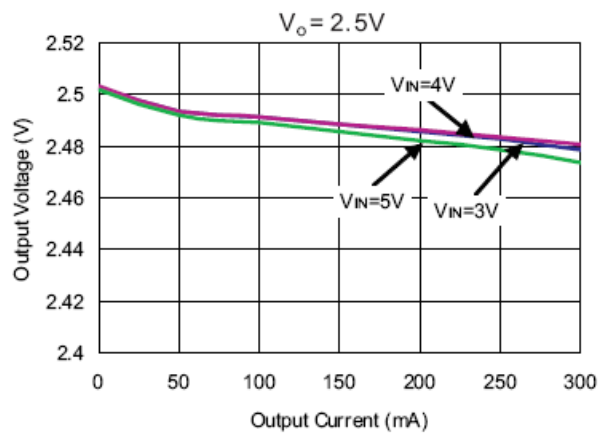
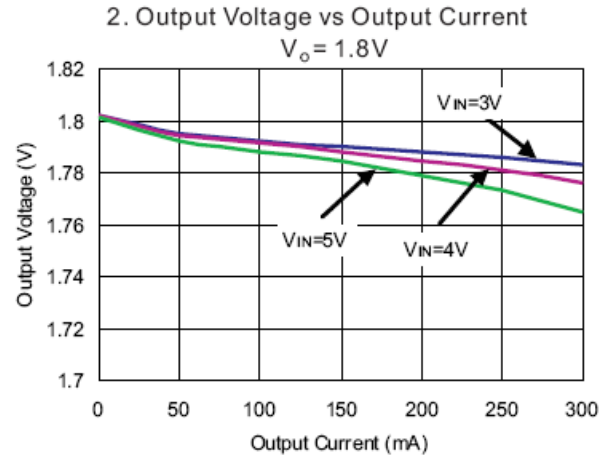

Typical Performance Characteristics (cont.)

(@T_A = +25°C, V_{EN} = V_{IN}, C_{IN} = 1μF, C_O = 2.2μF, C_{BYP} = 10nF unless otherwise specified.)

3. Output Voltage vs Temperature

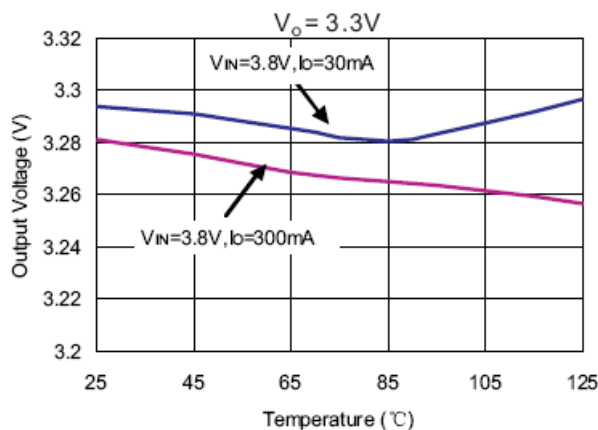
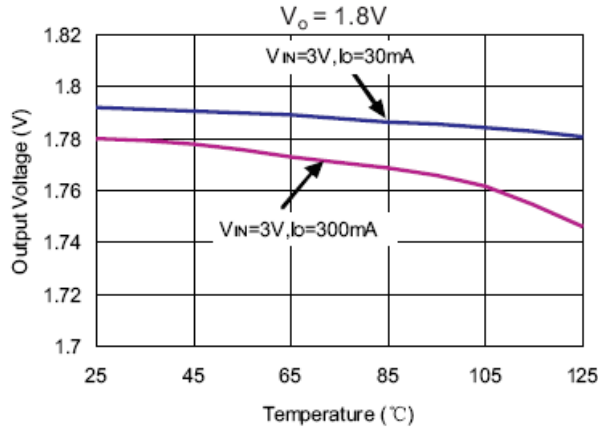

4. Ground Current vs Input Voltage

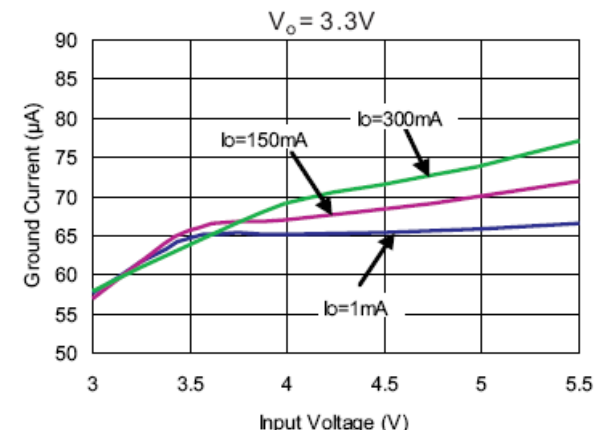
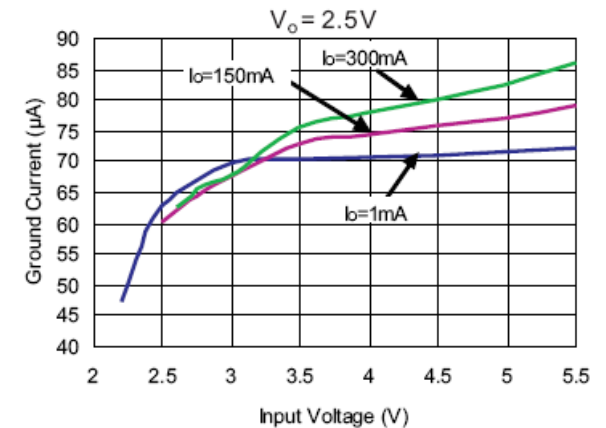
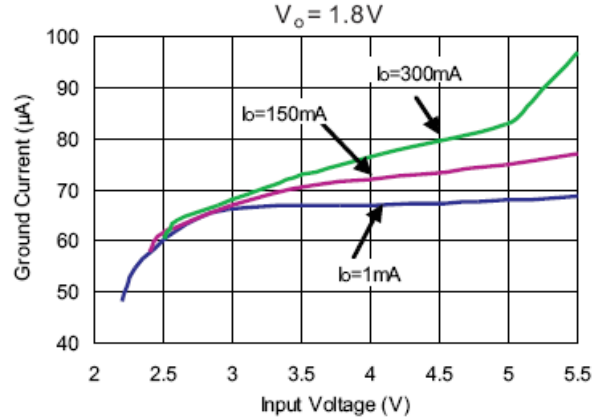

Typical Performance Characteristics (cont.)

(@T_A = +25°C, V_{EN} = V_{IN}, C_{IN} = 1μF, C_O = 2.2μF, C_{BYP} = 10nF unless otherwise specified.)

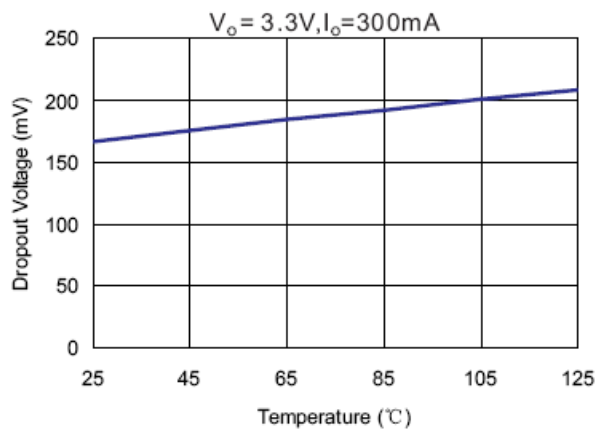
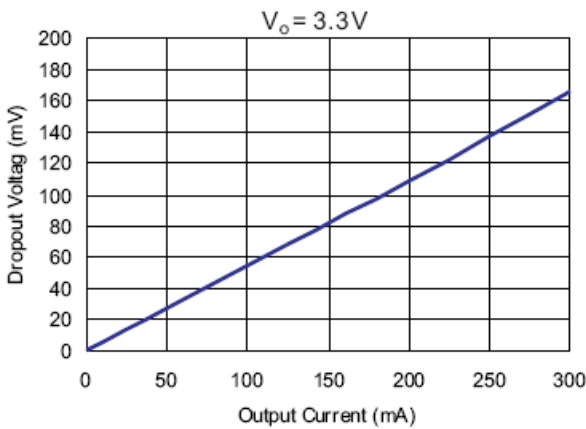

Typical Performance Characteristics (cont.)

(@T_A = +25°C, V_{EN} = V_{IN}, C_{IN} = 1μF, C_O = 2.2μF, C_{BYP} = 10nF unless otherwise specified.)

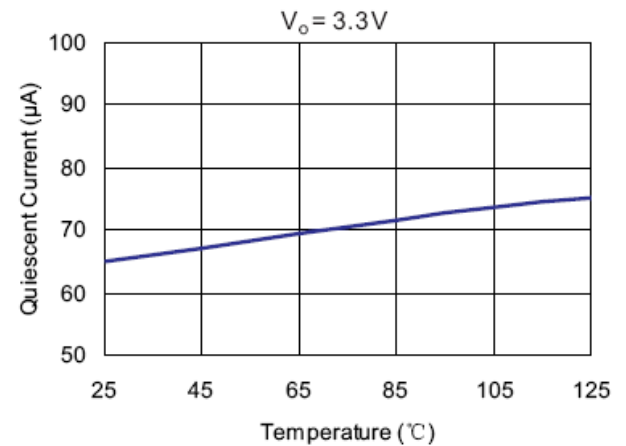
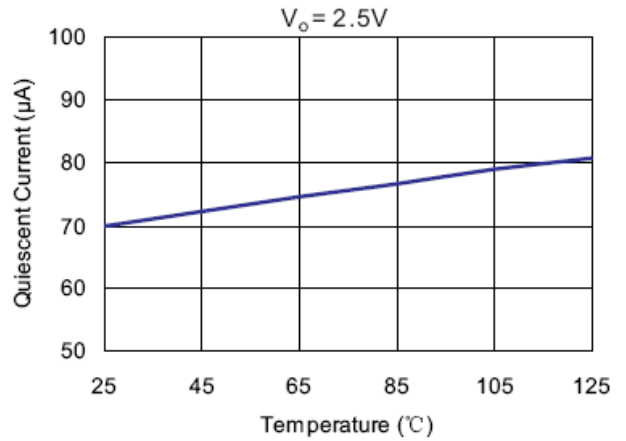
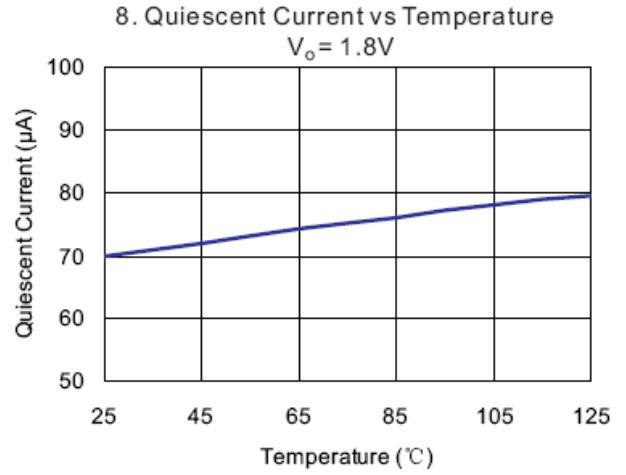
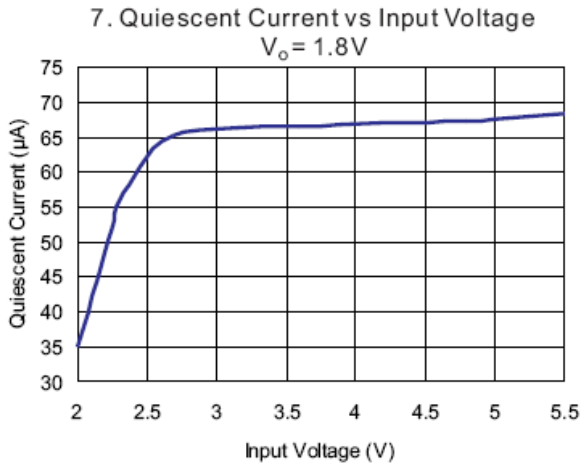

Typical Performance Characteristics (cont.)

(@T_A = +25°C, V_{EN} = V_{IN}, C_{IN} = 1μF, C_O = 2.2μF, C_{BYP} = 10nF unless otherwise specified.)

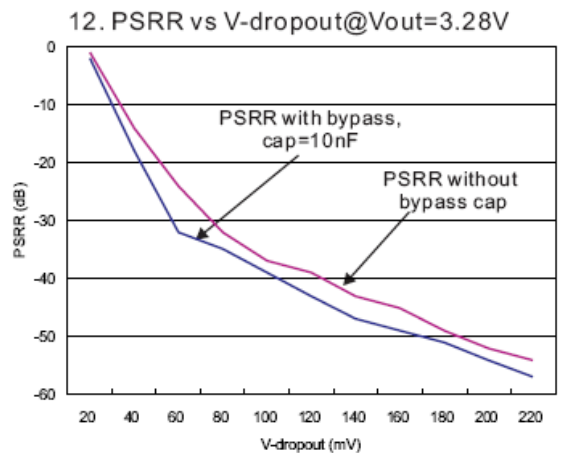
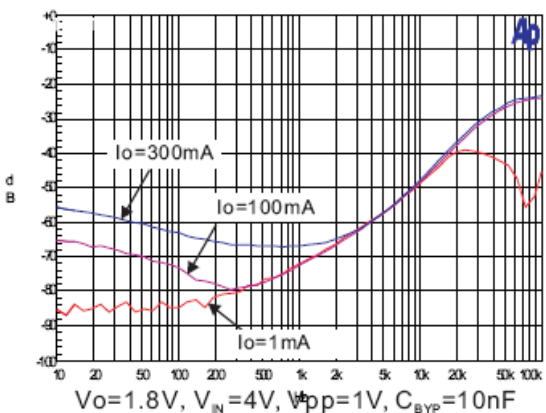
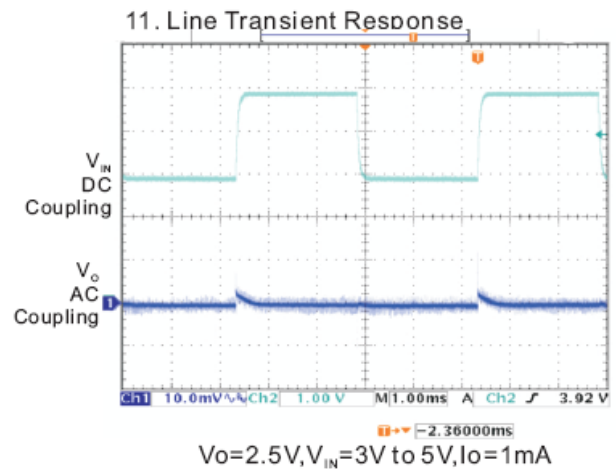
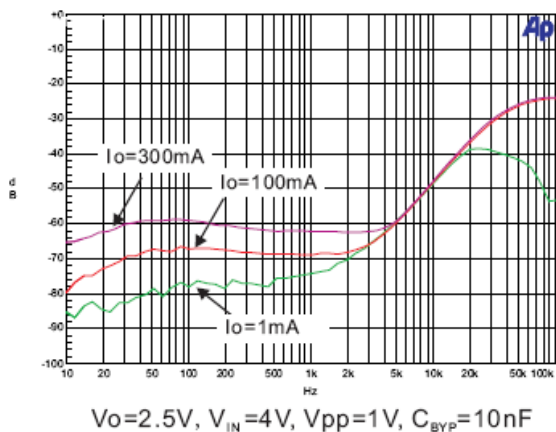
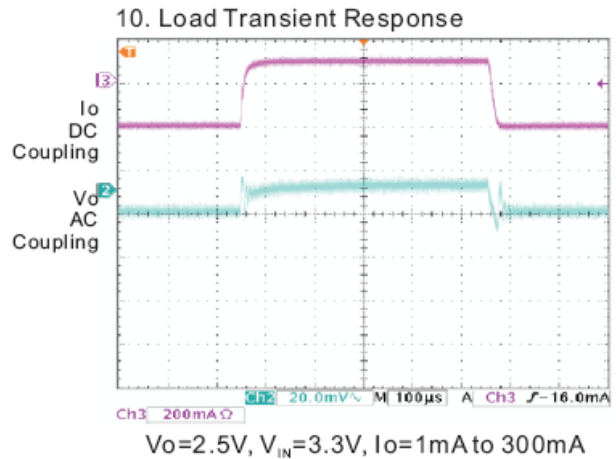
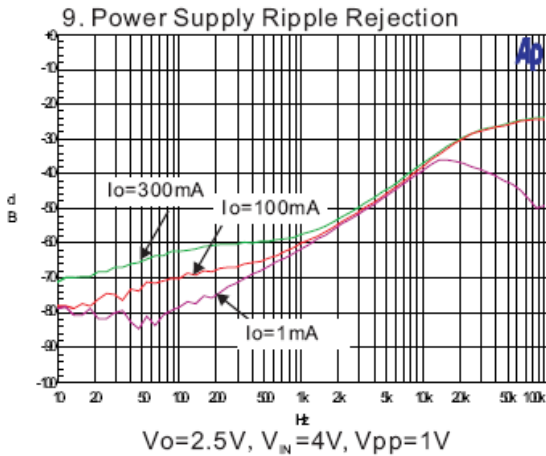

Typical Performance Characteristics (cont.)

(@T_A = +25°C, V_{EN} = V_{IN}, C_{IN} = 1μF, C_O = 2.2μF, C_{BYP} = 10nF unless otherwise specified.)

13. Turn-on Response



Application Information

Capacitor Selection and Regulator Stability

Similar to any low dropout regulator, the external capacitors used with the PAM3101 must be carefully selected for regulator stability and performance.

A capacitor C_{IN} of more than $1\mu\text{F}$ can be employed in the input pin, while there is no upper limit for the capacitance of C_{IN} . Please note that the distance between C_{IN} and the input pin of the PAM3101 should not exceed 0.5 inch. Ceramic capacitors are suitable for the PAM3101. Capacitors with larger values and lower ESR (equivalent series resistance) provide better PSRR and line-transient response.

The PAM3101 is designed specifically to work with low ESR ceramic output capacitors in order to save space and improve performance. Using an output ceramic capacitor whose value is $>2.2\mu\text{F}$ with $\text{ESR} > 5\text{m}\Omega$ ensures stability.

A 10nF bypass capacitor connected to BYP pin is suggested for suppressing output noise. The capacitor, in series connection with an internal 200k Ω resistor, forms a low-pass filter for noise reduction. Increasing the capacitance will slightly decrease the output noise, but increase the start-up time.

Load Transient Consideration

Curve 10 of the PAM3101 load-transient response on page 10 shows two components of the output response; a DC shift from the output impedance due to the load current change and transient response. The DC shift is quite small due to excellent load regulation of the PAM3101. The transient spike, resulting from a step change in the load current from 1mA to 300mA, is 20mV. The ESR of the output capacitor is critical to the transient spike. A larger capacitance with smaller ESR results in a smaller spike.

Shutdown Input Operation

The PAM3101 is shut down by pulling the EN input low, and is turned on by tying the EN input to V_{IN} .

Internal P-Channel Pass Transistor

The PAM3101 features a 0.75 Ω P-Channel MOSFET device as a pass transistor. The PMOS pass transistor enables the PAM3101 to consume only 65 μA of ground current during low dropout, light-load, or heavy-load operations. This feature increases the battery operation life time.

Input-Output (Dropout) Voltage

A regulator's minimum input-output voltage difference (or dropout voltage) determines the lowest usable supply voltage. The PAM3101 has a typical 300mV dropout voltage. In battery powered systems, this will determine the useful end-of-life battery voltage.

Current Limit and Short Circuit Protection

The PAM3101 features a current limit, which monitors and controls the gate voltage of the pass transistor. The output current can be limited to 400mA by regulating the gate voltage. The PAM3101 also has a built-in short circuit current limit.

Thermal Considerations

Thermal protection limits power dissipation in the PAM3101. When the junction temperature exceeds $+150^{\circ}\text{C}$, the OTP (Over Temperature Protection) starts the thermal shutdown and turns the pass transistor off. The pass transistor resumes operation after the junction temperature drops below $+120^{\circ}\text{C}$.

For continuous operation, the junction temperature should be maintained below $+125^{\circ}\text{C}$. The power dissipation is defined as:

$$P_D = (V_{IN} - V_{OUT}) \cdot I_O + V_{IN} \cdot I_{GND}$$

The maximum power dissipation depends on the thermal resistance of IC package, PCB layout, the rate of surrounding airflow and temperature difference between junction and ambient. The maximum power dissipation can be calculated by the following formula:

$$P_{D(MAX)} = (T_{J(MAX)} - T_A) / \theta_{JA}$$

Where $T_{J(MAX)}$ is the maximum allowable junction temperature $+125^{\circ}\text{C}$, T_A is the ambient temperature and θ_{JA} is the thermal resistance from the junction to the ambient.

Application Information (cont.)

For example, as θ_{JA} is 250°C/W for the SOT-23 package and 180°C/W for the SOT-89 package based on the standard JEDEC 51-3 for a single-layer thermal test board, the maximum power dissipation at $T_A + 25^\circ\text{C}$ can be calculated by following formula:

$$P_{D(\text{MAX})} = (125^\circ\text{C} - 25^\circ\text{C}) / 250 = 0.4\text{W SOT-23}$$

$$P_{D(\text{MAX})} = (125^\circ\text{C} - 25^\circ\text{C}) / 180 = 0.55\text{W SOT-89}$$

It is also useful to calculate the junction temperature of the PAM3101 under a set of specific conditions. Suppose the input voltage $V_{IN} = 3.3\text{V}$, the output current $I_O = 300\text{mA}$ and the case temperature $T_A = +40^\circ\text{C}$ measured by a thermocouple during operation, the power dissipation for the $V_O = 2.8\text{V}$ version of the PAM3101 can be calculated as:

$$P_D = (3.3\text{V} - 2.8\text{V}) * 300\text{mA} + 3.3\text{V} * 70\mu\text{A} \cong 150\text{mW}$$

And the junction temperature, T_J can be calculated as follows:

$$T_J = T_A + P_D * \theta_{JA}$$

$$T_J = 40^\circ\text{C} + 0.15\text{W} * 250^\circ\text{C/W}$$

$$= 40^\circ\text{C} + 37.5^\circ\text{C}$$

$$= 77.5^\circ\text{C} < T_{J(\text{MAX})} = +125^\circ\text{C}$$

For this application, T_J is lower than the absolute maximum operating junction temperature, $+125^\circ\text{C}$, so it is safe to use the PAM3101 in this configuration.

NOT RECOMMENDED
FOR NEW DESIGN

Ordering Information



Pin Configuration		Package Type	Number of Pins	Output Voltage
A Type: 1. GND 2. VOUT 3. VIN	E Type: 1. VOUT 2. GND 3. NC 4. EN (EN Default floating) 5. VIN	A: SOT23 C: SOT-89 U: SC70 K: DFN1.6x1.6	A: 3 K: 4 B: 5 F: 6	475: 4.75V 400: 4.0V 380: 3.8V 330: 3.3 V 310: 3.1V 290: 2.9V 285: 2.85V 280: 2.8V 250: 2.5V 200: 2.0V 180: 1.8V 150: 1.5V
B Type: 1. VIN 2. GND 3. EN (EN Default floating) 4. NC 5. VOUT	F Type: 1. EN (EN Default floating) 2. NC 3. VIN 4. VOUT 5. NC 6. GND			
C Type: 1. VOUT 2. GND 3. VIN	G Type: 1. VIN 2. VOUT 3. GND			
D Type: 1. VIN 2. GND 3. EN (EN Default pull high) 4. BYP 5. VOUT	H Type: 1. GND 2. VIN 3. VOUT			

NOT RECOMMENDED FOR NEW DESIGN

Ordering Information (cont.)

Part Number	Output Voltage	Marking	Package Type	Shipping Package
PAM3101AAA475	4.75V	AATYW	SOT23-3	3,000Units/Tape&Reel
PAM3101AAA400	4.0V	AAMYW	SOT23-3	3,000Units/Tape&Reel
PAM3101AAA380	3.8V	AAOYW	SOT23-3	3,000Units/Tape&Reel
PAM3101AAA330	3.3V	AAKYW	SOT23-3	3,000Units/Tape&Reel
PAM3101AAA310	3.1V	AAPYW	SOT23-3	3,000Units/Tape&Reel
PAM3101AAA300	3.0V	AAJYW	SOT23-3	3,000Units/Tape&Reel
PAM3101AAA290	2.9V	AAQYW	SOT23-3	3,000Units/Tape&Reel
PAM3101AAA285	2.85V	AAIYW	SOT23-3	3,000Units/Tape&Reel
PAM3101AAA280	2.8V	AAHYW	SOT23-3	3,000Units/Tape&Reel
PAM3101AAA250	2.5V	AAGYW	SOT23-3	3,000Units/Tape&Reel
PAM3101AAA180	1.8V	AAEYW	SOT23-3	3,000Units/Tape&Reel
PAM3101AAA150	1.5V	AACYW	SOT23-3	3,000Units/Tape&Reel
PAM3101GAA475	4.75V	AATYW	SOT23-3	3,000Units/Tape&Reel
PAM3101GAA400	4.0V	AAMYW	SOT23-3	3,000Units/Tape&Reel
PAM3101GAA380	3.8V	AAOYW	SOT23-3	3,000Units/Tape&Reel
PAM3101GAA330	3.3V	AAKYW	SOT23-3	3,000Units/Tape&Reel
PAM3101GAA310	3.1V	AAPYW	SOT23-3	3,000Units/Tape&Reel
PAM3101GAA300	3.0V	AAJYW	SOT23-3	3,000Units/Tape&Reel
PAM3101GAA290	2.9V	AAQYW	SOT23-3	3,000Units/Tape&Reel
PAM3101GAA285	2.85V	AAIYW	SOT23-3	3,000Units/Tape&Reel
PAM3101GAA280	2.8V	AAHYW	SOT23-3	3,000Units/Tape&Reel
PAM3101GAA250	2.5V	AAGYW	SOT23-3	3,000Units/Tape&Reel
PAM3101GAA180	1.8V	AAEYW	SOT23-3	3,000Units/Tape&Reel
PAM3101GAA150	1.5V	AACYW	SOT23-3	3,000Units/Tape&Reel
PAM3101CAA475	4.75V	AATYW	SOT23-3	3,000Units/Tape&Reel
PAM3101CAA400	4.0V	AAMYW	SOT23-3	3,000Units/Tape&Reel
PAM3101CAA380	3.8V	AAOYW	SOT23-3	3,000Units/Tape&Reel
PAM3101CAA330	3.3V	AAKYW	SOT23-3	3,000Units/Tape&Reel
PAM3101CAA310	3.1V	AAPYW	SOT23-3	3,000Units/Tape&Reel
PAM3101CAA300	3.0V	AAJYW	SOT23-3	3,000Units/Tape&Reel
PAM3101CAA290	2.9V	AAQYW	SOT23-3	3,000Units/Tape&Reel
PAM3101CAA285	2.85V	AAIYW	SOT23-3	3,000Units/Tape&Reel
PAM3101CAA280	2.8V	AAHYW	SOT23-3	3,000Units/Tape&Reel
PAM3101CAA250	2.5V	AAGYW	SOT23-3	3,000Units/Tape&Reel
PAM3101CAA180	1.8V	AAEYW	SOT23-3	3,000Units/Tape&Reel
PAM3101CAA150	1.5V	AACYW	SOT23-3	3,000Units/Tape&Reel

Ordering Information (cont.)

Part Number	Output Voltage	Marking	Package Type	Shipping Package
PAM3101CCA475	4.75V	P3101T XXXYW	SOT89-3	1,000Units/Tape&Reel
PAM3101CCA400	4.0V	P3101M XXXYW	SOT89-3	1,000Units/Tape&Reel
PAM3101CCA380	3.8V	P3101O XXXYW	SOT89-3	1,000Units/Tape&Reel
PAM3101CCA330	3.3V	P3101K XXXYW	SOT89-3	1,000Units/Tape&Reel
PAM3101CCA310	3.1V	P3101P XXXYW	SOT89-3	1,000Units/Tape&Reel
PAM3101CCA300	3.0V	P3101J XXXYW	SOT89-3	1,000Units/Tape&Reel
PAM3101CCA290	2.9V	P3101Q XXXYW	SOT89-3	1,000Units/Tape&Reel
PAM3101CCA285	2.85V	P3101I XXXYW	SOT89-3	1,000Units/Tape&Reel
PAM3101CCA280	2.8V	P3101H XXXYW	SOT89-3	1,000Units/Tape&Reel
PAM3101CCA250	2.5V	P3101G XXXYW	SOT89-3	1,000Units/Tape&Reel
PAM3101CCA180	1.8V	P3101E XXXYW	SOT89-3	1,000Units/Tape&Reel
PAM3101CCA150	1.5V	P3101C XXXYW	SOT89-3	1,000Units/Tape&Reel
PAM3101HCA475	4.75V	P3101T XXXYW	SOT89-3	1,000Units/Tape&Reel
PAM3101HCA400	4.0V	P3101M XXXYW	SOT89-3	1,000Units/Tape&Reel
PAM3101HCA380	3.8V	P3101O XXXYW	SOT89-3	1,000Units/Tape&Reel
PAM3101HCA330	3.3V	P3101K XXXYW	SOT89-3	1,000Units/Tape&Reel
PAM3101HCA310	3.1V	P3101P XXXYW	SOT89-3	1,000Units/Tape&Reel
PAM3101HCA300	3.0V	P3101J XXXYW	SOT89-3	1,000Units/Tape&Reel
PAM3101HCA290	2.90V	P3101Q XXXYW	SOT89-3	1,000Units/Tape&Reel
PAM3101HCA285	2.85V	P3101I XXXYW	SOT89-3	1,000Units/Tape&Reel
PAM3101HCA280	2.8V	P3101H XXXYW	SOT89-3	1,000Units/Tape&Reel

Ordering Information (cont.)

Part Number	Output Voltage	Marking	Package Type	Shipping Package
PAM3101HCA250	2.5V	P3101G XXXYW	SOT89-3	1,000Units/Tape&Reel
PAM3101HCA180	1.8V	P3101E XXXYW	SOT89-3	1,000Units/Tape&Reel
PAM3101HCA150	1.5V	P3101C XXXYW	SOT89-3	1,000Units/Tape&Reel
PAM3101DAB475	4.75V	AATYW	SOT23-5	3,000Units/Tape&Reel
PAM3101DAB400	4.0V	AAMYW	SOT23-5	3,000Units/Tape&Reel
PAM3101DAB380	3.8V	AAOYW	SOT23-5	3,000Units/Tape&Reel
PAM3101DAB330	3.3V	AAKYW	SOT23-5	3,000Units/Tape&Reel
PAM3101DAB310	3.1V	AAPYW	SOT23-5	3,000Units/Tape&Reel
PAM3101DAB300	3.0V	AAJYW	SOT23-5	3,000Units/Tape&Reel
PAM3101DAB290	2.9V	AAQYW	SOT23-5	3,000Units/Tape&Reel
PAM3101DAB285	2.85V	AAIYW	SOT23-5	3,000Units/Tape&Reel
PAM3101DAB280	2.8V	AAHYW	SOT23-5	3,000Units/Tape&Reel
PAM3101DAB250	2.5V	AAGYW	SOT23-5	3,000Units/Tape&Reel
PAM3101DAB180	1.8V	AAEYW	SOT23-5	3,000Units/Tape&Reel
PAM3101DAB150	1.5V	AACYW	SOT23-5	3,000Units/Tape&Reel
PAM3101ECB475	4.75V	P3101T XXXYW	SOT89-5	1,000Units/Tape&Reel
PAM3101ECB400	4.0V	P3101M XXXYW	SOT89-5	1,000Units/Tape&Reel
PAM3101ECB380	3.8V	P3101O XXXYW	SOT89-5	1,000Units/Tape&Reel
PAM3101ECB330	3.3V	P3101K XXXYW	SOT89-5	1,000Units/Tape&Reel
PAM3101ECB310	3.1V	P3101P XXXYW	SOT89-5	1,000Units/Tape&Reel
PAM3101ECB300	3.0V	P3101J XXXYW	SOT89-5	1,000Units/Tape&Reel
PAM3101ECB290	2.9V	P3101Q XXXYW	SOT89-5	1,000Units/Tape&Reel
PAM3101ECB285	2.85V	P3101I XXXYW	SOT89-5	1,000Units/Tape&Reel
PAM3101ECB280	2.8V	P3101H XXXYW	SOT89-5	1,000Units/Tape&Reel
PAM3101ECB250	2.5V	P3101G XXXYW	SOT89-5	1,000Units/Tape&Reel
PAM3101ECB180	1.8V	P3101E XXXYW	SOT89-5	1,000Units/Tape&Reel
PAM3101ECB150	1.5V	P3101C XXXYW	SOT89-5	1,000Units/Tape&Reel

Ordering Information (cont.)

Part Number	Output Voltage	Marking	Package Type	Shipping Package
PAM3101GUA475	4.75V	AATYW	SC70-3L	3,000Units/Tape&Reel
PAM3101GUA400	4.0V	AAMYW	SC70-3L	3,000Units/Tape&Reel
PAM3101GUA380	3.8V	AAOYW	SC70-3L	3,000Units/Tape&Reel
PAM3101GUA330	3.3V	AAKYW	SC70-3L	3,000Units/Tape&Reel
PAM3101GUA310	3.1V	AAPYW	SC70-3L	3,000Units/Tape&Reel
PAM3101GUA300	3.0V	AAJYW	SC70-3L	3,000Units/Tape&Reel
PAM3101GUA290	2.9V	AAQYW	SC70-3L	3,000Units/Tape&Reel
PAM3101GUA285	2.85V	AAIYW	SC70-3L	3,000Units/Tape&Reel
PAM3101GUA280	2.8V	AAHYW	SC70-3L	3,000Units/Tape&Reel
PAM3101GUA250	2.5V	AAGYW	SC70-3L	3,000Units/Tape&Reel
PAM3101GUA180	1.8V	AAEYW	SC70-3L	3,000Units/Tape&Reel
PAM3101GUA150	1.5V	AACYW	SC70-3L	3,000Units/Tape&Reel
PAM3101DUB475	4.75V	AATYW	SC70-5L	3,000Units/Tape&Reel
PAM3101DUB400	4.0V	AAMYW	SC70-5L	3,000Units/Tape&Reel
PAM3101DUB380	3.8V	AAOYW	SC70-5L	3,000Units/Tape&Reel
PAM3101DUB330	3.3V	AAKYW	SC70-5L	3,000Units/Tape&Reel
PAM3101DUB310	3.1V	AAPYW	SC70-5L	3,000Units/Tape&Reel
PAM3101DUB300	3.0V	AAJYW	SC70-5L	3,000Units/Tape&Reel
PAM3101DUB290	2.9V	AAQYW	SC70-5L	3,000Units/Tape&Reel
PAM3101DUB285	2.85V	AAIYW	SC70-5L	3,000Units/Tape&Reel
PAM3101DUB280	2.8V	AAHYW	SC70-5L	3,000Units/Tape&Reel
PAM3101DUB250	2.5V	AAGYW	SC70-5L	3,000Units/Tape&Reel
PAM3101DUB180	1.8V	AAEYW	SC70-5L	3,000Units/Tape&Reel
PAM3101DUB150	1.5V	AACYW	SC70-5L	3,000Units/Tape&Reel

NO FOR

Marking Information

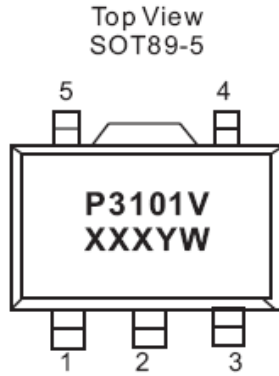
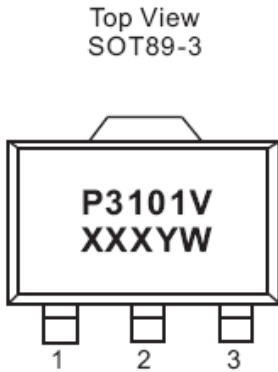
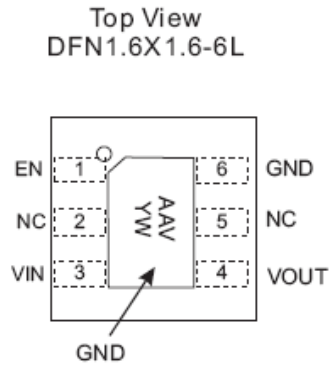
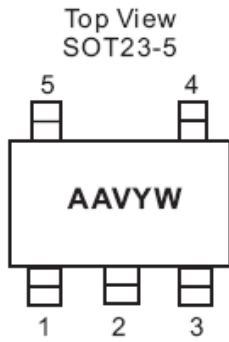
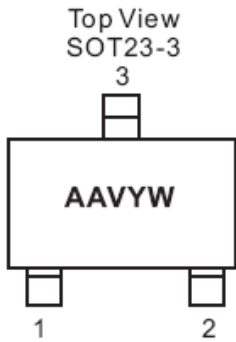

AA: Product Code of PAM3101
V: Voltage Code
X: Internal Code
Y: Year
W: Week

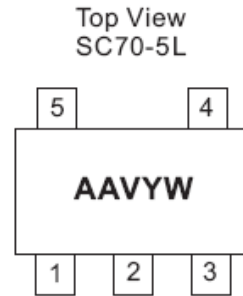
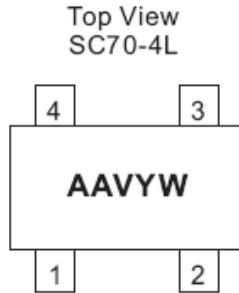
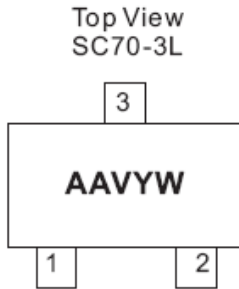

NEW

Package Outline Dimensions (All dimensions in mm.)

SOT23-3



Dim	Millimeters		
	Min.	Typ.	Max.
A	1.00	1.15	1.30
A1	0.00	0.05	0.10
B	0.35	0.43	0.51
C	0.10	0.175	0.25
D	2.70	2.90	3.10
E	1.40	1.60	1.80
e	1.90BSC		
H	2.40	2.70	3.00
L	0.37		



NOT REC
FOR NEW

Package Outline Dimensions (cont.) (All dimensions in mm.)

SOT23-5



REF.	Millimeter	
	Min	Max
A	1.10MAX	
A1	0	0.10
A2	0.70	1
c	0.12REF.	
D	2.70	3.10
E	2.60	3.00
E1	1.40	1.80
L	0.45REF.	
L1	0.60REF.	
θ	0°	10°
b	0.30	0.50
e	0.95REF.	
e1	1.90REF.	

Package Outline Dimensions (cont.) (All dimensions in mm.)

SOT89-3

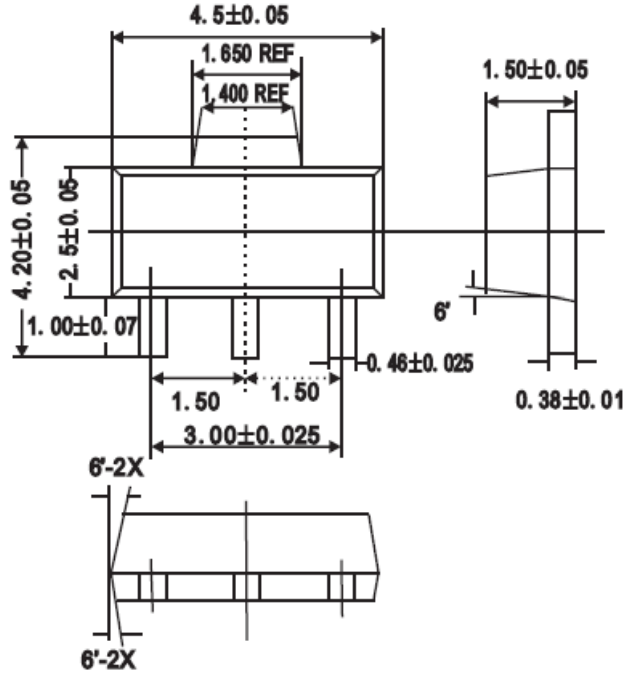

(Unit: mm)

SOT89-5

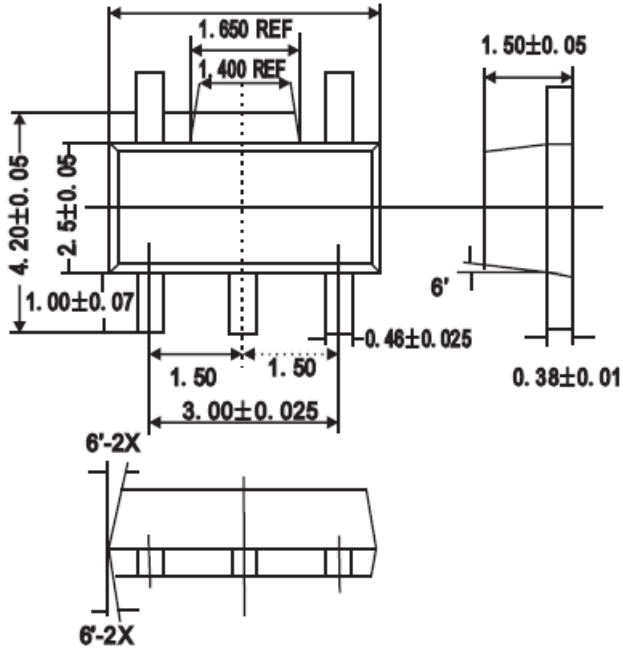

(Unit: mm)

Package Outline Dimensions (cont.) (All dimensions in mm.)

SC70-3L



REF.	Millimeter		REF.	Millimeter	
	Min.	Max.		Min.	Max.
A	0.80	1.10	L1	0.42 REF.	
A1	0	0.10	L	0.15	0.35
A2	0.80	1.00	b	0.25	0.40
D	1.80	2.20	c	0.10	0.25
E	1.15	1.35	e		
HE	1.80	2.40			

N
K

Package Outline Dimensions (All dimensions in mm.)

SC70-4L



SYMBOL	MIN	MAX
e	0.65	BSC
e1	0.50	BSC
D	1.80	2.20
b	0.15	0.30
b1	0.575	0.700
E	1.15	1.35
HE	1.80	2.40
Q1	0.10	0.40
A2	0.80	1.00
A1	0.00	0.10
A	0.80	1.10
c	0.10	0.18
L	0.10	0.30
Lj	0.26	0.46

- 1) ALL DIMENSIONS ARE IN MILLIMETERS
- 2) DIMENSIONS ARE INCLUSIVE OF PLATING
- 3) DIMENSIONS ARE EXCLUSIVE OF MOLD FLASH & METAL BURR
- 4) CUSTOM LEADCOUNT VARIATION OF JEITA SC70

Package Outline Dimensions (All dimensions in mm.)

DFN 1.6x1.6-6L

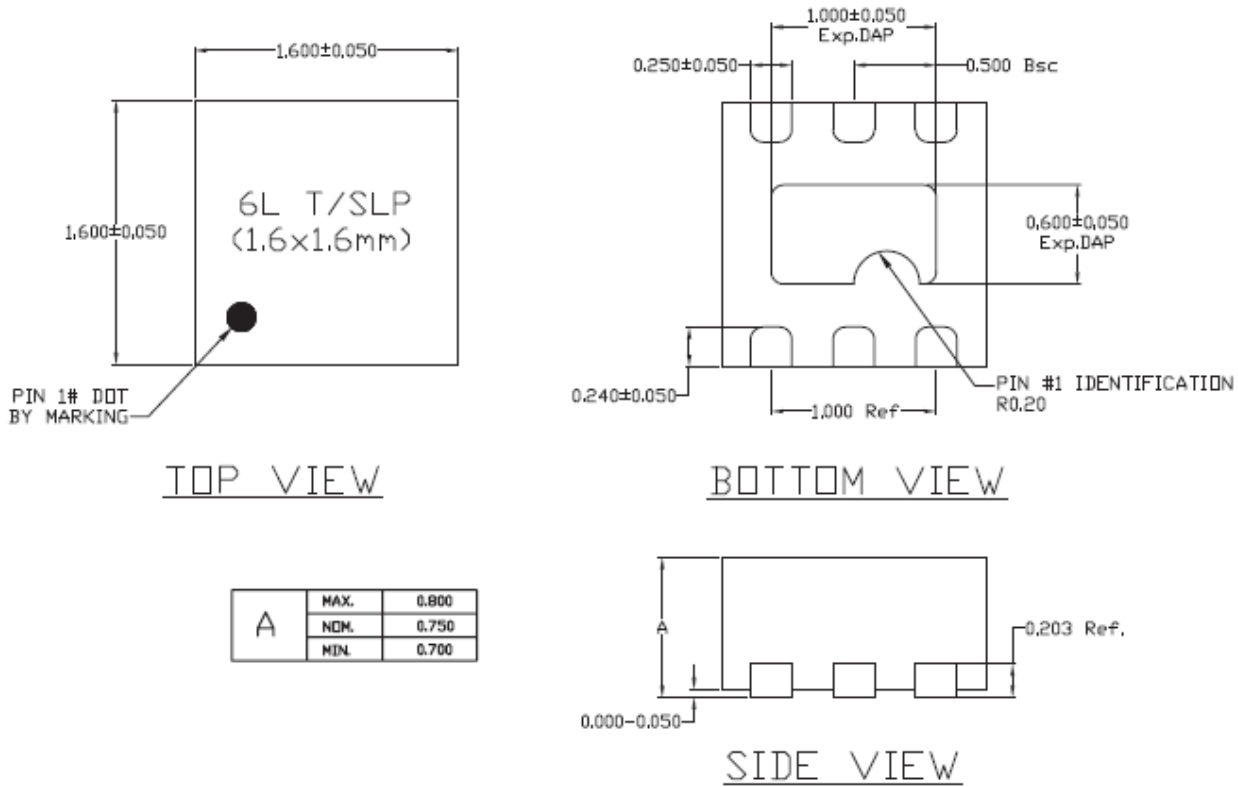

Note: All dimensions are in Millimeters.

NOT RECOMMENDED FOR NEW DESIGN

IMPORTANT NOTICE

DIODES INCORPORATED MAKES NO WARRANTY OF ANY KIND, EXPRESS OR IMPLIED, WITH REGARDS TO THIS DOCUMENT, INCLUDING, BUT NOT LIMITED TO, THE IMPLIED WARRANTIES OF MERCHANTABILITY AND FITNESS FOR A PARTICULAR PURPOSE (AND THEIR EQUIVALENTS UNDER THE LAWS OF ANY JURISDICTION).

Diodes Incorporated and its subsidiaries reserve the right to make modifications, enhancements, improvements, corrections or other changes without further notice to this document and any product described herein. Diodes Incorporated does not assume any liability arising out of the application or use of this document or any product described herein; neither does Diodes Incorporated convey any license under its patent or trademark rights, nor the rights of others. Any Customer or user of this document or products described herein in such applications shall assume all risks of such use and will agree to hold Diodes Incorporated and all the companies whose products are represented on Diodes Incorporated website, harmless against all damages.

Diodes Incorporated does not warrant or accept any liability whatsoever in respect of any products purchased through unauthorized sales channel. Should Customers purchase or use Diodes Incorporated products for any unintended or unauthorized application, Customers shall indemnify and hold Diodes Incorporated and its representatives harmless against all claims, damages, expenses, and attorney fees arising out of, directly or indirectly, any claim of personal injury or death associated with such unintended or unauthorized application.

Products described herein may be covered by one or more United States, international or foreign patents pending. Product names and markings noted herein may also be covered by one or more United States, international or foreign trademarks.

This document is written in English but may be translated into multiple languages for reference. Only the English version of this document is the final and determinative format released by Diodes Incorporated.

LIFE SUPPORT

Diodes Incorporated products are specifically not authorized for use as critical components in life support devices or systems without the express written approval of the Chief Executive Officer of Diodes Incorporated. As used herein:

A. Life support devices or systems are devices or systems which:

1. are intended to implant into the body, or
2. support or sustain life and whose failure to perform when properly used in accordance with instructions for use provided in the labeling can be reasonably expected to result in significant injury to the user.

B. A critical component is any component in a life support device or system whose failure to perform can be reasonably expected to cause the failure of the life support device or to affect its safety or effectiveness.



Customers represent that they have all necessary expertise in the safety and regulatory ramifications of their life support devices or systems, and acknowledge and agree that they are solely responsible for all legal, regulatory and safety-related requirements concerning their products and any use of Diodes Incorporated products in such safety-critical, life support devices or systems, notwithstanding any devices- or systems-related information or support that may be provided by Diodes Incorporated. Further, Customers must fully indemnify Diodes Incorporated and its representatives against any damages arising out of the use of Diodes Incorporated products in such safety-critical, life support devices or systems.

Copyright © 2016, Diodes Incorporated

www.diodes.com

Looking for pricing, stock, or lifecycle information?

Click below to explore more details on WIN SOURCE:

-  [View PAM3101BAB330 on WIN SOURCE](#)
-  [Diodes Incorporated Information](#)

Optimize Your Supply Chain with WIN SOURCE Solutions

-  Global Sourcing Solution
-  Obsolete Management
-  Cost Control Management
-  Shortage Management
-  Alternative Solution
-  Excess Inventory Management