



**THE DATASHEET OF
PT7A7533WE**



Features

- Precision supply-voltage monitor
 - ♦ 4.63V (PT7A7511, 7521, 7531)
 - ♦ 4.38V (PT7A7512, 7522, 7532)
 - ♦ 3.08V (PT7A7513, 7523, 7533)
 - ♦ 2.93V (PT7A7514, 7524, 7534)
 - ♦ 2.63V (PT7A7515, 7525, 7535)
- 200ms reset pulse width
- Debounced TTL/CMOS-compatible manual reset input
- Independent watchdog timer 1.6sec time-out (not available for PT7A7531 - 7535)
- Reset output signal:
 - ♦ Active-low only (PT7A7511 - 7515)
 - ♦ Active-high only (PT7A7521 - 7525)
 - ♦ Active-high and active-low (PT7A7531 - 7535)
- Voltage monitor for power-fail or low battery warning
- Guaranteed RESET/RESET valid at VCC=1.2V
- Totally Lead-Free & Fully RoHS Compliant (Notes 1 & 2)
- Halogen and Antimony Free. "Green" Device (Note 3)
- For automotive applications requiring specific change control (i.e. parts qualified to AEC-Q100/101/200, PPAP capable, and manufactured in IATF 16949 certified facilities), please [contact us](https://www.diodes.com/contact-us) or your local Diodes representative.

<https://www.diodes.com/quality/product-definitions/>

Description

The PT7A751X/752X/753X family micro-processor (P) supervisory circuits are targeted to improve reliability and accuracy of power-supply circuitry in P's systems. These devices reduce the complexity and number of components required to monitor power-supply and battery functions.

The main functions are:

1. Asserting reset output during power-up, power-down and brownout conditions for P system.
2. Detecting power failure or low-battery conditions with a 1.25V threshold detector.
3. Watchdog functions (not for PT7A753x)

Applications

- Power-supply circuitry in µP systems

Notes:

1. No purposely added lead. Fully EU Directive 2002/95/EC (RoHS), 2011/65/EU (RoHS 2) & 2015/863/EU (RoHS 3) compliant.
2. See <https://www.diodes.com/quality/lead-free/> for more information about Diodes Incorporated's definitions of Halogen- and Antimony-free, "Green" and Lead-free.
3. Halogen- and Antimony-free "Green" products are defined as those which contain <900ppm bromine, <900ppm chlorine (<1500ppm total Br + Cl) and <1000ppm antimony compounds.

Block Diagram

Block Diagram of PT7A7511-7515/7521-7525

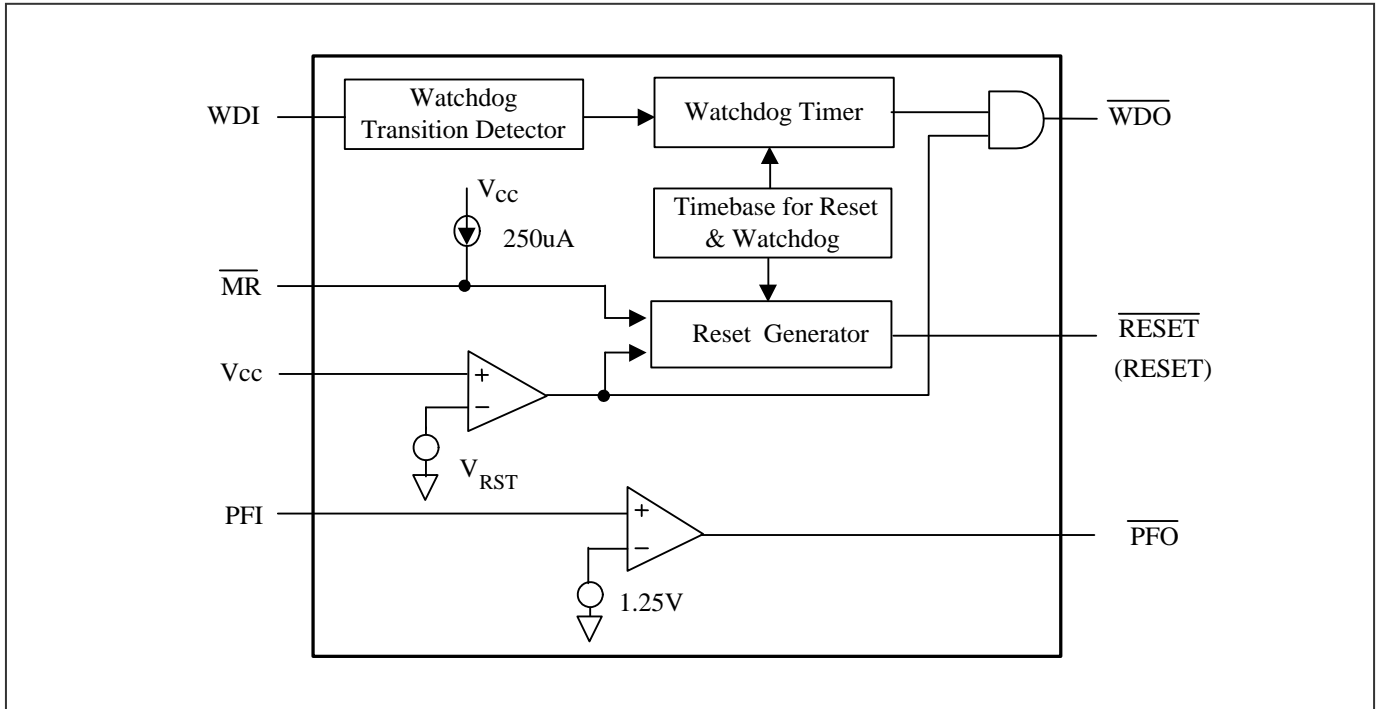

Block Diagram of PT7A7531-35

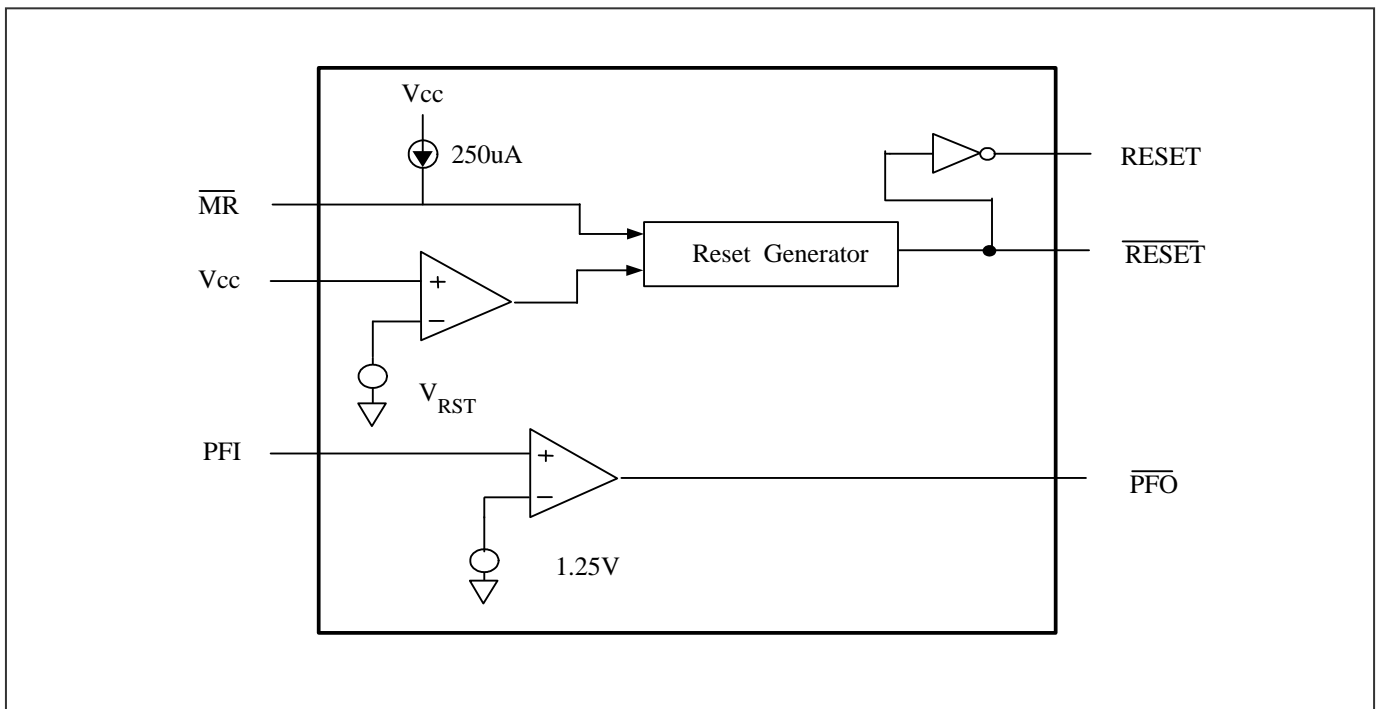

Pin Configuration

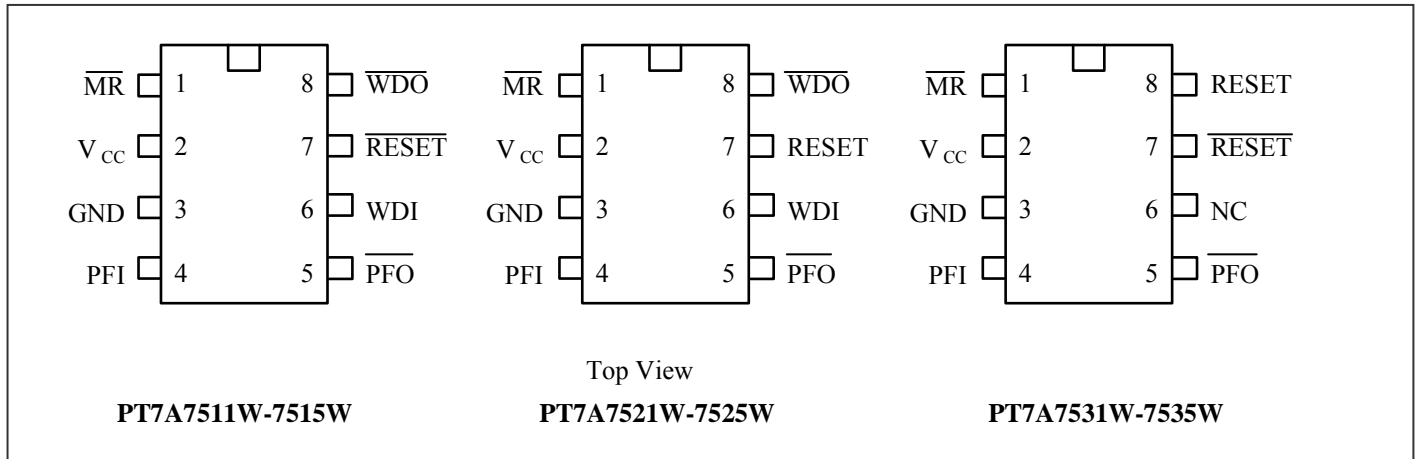

Pin Description

Pin	Type	Description
$\overline{\text{MR}}$	I	Manual-Reset: triggers a reset pulse when pulled below 0.8V, active low. It has an internal 250 μ A pull-up current and be driven from a TTL or CMOS logic line as well as shorted to ground with a switch.
V_{CC}	Power	Supply Voltage.
GND	Ground	Ground Reference for all signals.
PFI	I	Power-Fail Voltage Monitor Input. When PFI is less than 1.25V, PFO goes low. Connect PFI to GND or Vcc when not used.
$\overline{\text{PFO}}$	O	Power-Fail Output: it gets low and sinks current when PFI is less than 1.25V; otherwise $\overline{\text{PFO}}$ stays high.
WDI	I	Watchdog Input: If WDI remains high or low for 1.6sec, the internal watchdog timer runs out and $\overline{\text{WDO}}$ goes low. Floating WDI or connecting WDI to a high-impedance three-state buffer disables the watchdog feature. The internal watchdog timer clears whenever reset is asserted. WDI is three-stated, or WDI sees a rising or falling edge.
$\overline{\text{RESET}}$	O	Reset Output pulses: low for 200ms when triggered, and stays low whenever Vcc is below the reset threshold. It remains low for 200ms after Vcc rises <u>above</u> the reset threshold or $\overline{\text{MR}}$ goes from low to high. A watchdog timeout will not trigger $\overline{\text{RESET}}$ unless $\overline{\text{WDO}}$ is connected to MR.
$\overline{\text{WDO}}$	O	Watchdog Output: pulls low when the <u>internal</u> watchdog timer finishes its 1.6sec count and does not go high again until the watchdog is cleared. $\overline{\text{WDO}}$ also goes low <u>during low-line</u> conditions. Whenever Vcc is below the reset threshold, $\overline{\text{WDO}}$ stays low; however, <u>unlike</u> $\overline{\text{RESET}}$, $\overline{\text{WDO}}$ does not have minimum pulse width. As soon as Vcc rises above the reset threshold, $\overline{\text{WDO}}$ goes high with no delay.
RESET	O	The inverse of $\overline{\text{RESET}}$, active high. Whenever $\overline{\text{RESET}}$ is high, RESET is low.

Maximum Ratings

Storage Temperature	-65°C to +150°C
Ambient Temperature with Power Applied.....	-40°C to +85°C
Supply Voltage to Ground Potential (V _{CC} to GND)	-0.3V to +7.0V
DC Input Voltage (All inputs except V _{CC} and GND).....	-0.3V to V _{CC} +0.3V
DC Output Current (All outputs)	20mA
Power Dissipation	500mW (Depend on package)

Note:

Stresses greater than those listed under MAXIMUM RATINGS may cause permanent damage to the device. This is a stress rating only and functional operation of the device at these or any other conditions above those indicated in the operational sections of this specification is not implied. Exposure to absolute maximum rating conditions for extended periods may affect reliability.

Recommended Operation Conditions

Symbol	Description	Test Conditions	Min.	Typ.	Max.	Unit
V _{CC}	Supply Voltage for 75x1,75x2	-	4.5	5.0	5.5	V
	Supply Voltage for 75x3,75x4	-	3.0	3.3	5.5	V
	Supply Voltage for 75x5	-	2.7	3.0	5.5	V
V _{IH1}	MR Input $\overline{\text{High}}$ Voltage	V _{CC} > 4.0V	2.0	2.4	-	V
		V _{CC} ≤ 4.0V	0.7V _{CC}	-	-	V
V _{IH2}	WDI Input High Voltage	-	0.7V _{CC}	-	-	V
V _{IL1}	MR Input $\overline{\text{Low}}$ Voltage	V _{CC} > 4.0V	-	-	0.8	V
		V _{CC} ≤ 4.0V	-	-	0.2V _{CC}	V
V _{IL2}	WDI Input Low Voltage	-	-	-	0.3V _{CC}	V
T _A	Operating Temperature	-	-40	-	85	°C

DC Electrical Characteristics

(V_{CC} = V_{RN} + 5% to 5.5V, T_A = -40~85°C, unless otherwise noted.)(Note 1)

Symbol	Description	Test Conditions	Min.	Typ.	Max.	Unit
I _{CC}	Supply Current	75x1/x2 V _{CC} = 5V, 75x3/x4 V _{CC} = 3.3V, 75x5 V _{CC} = 3.0V, Left WDI un- connected (No output load)	-	30	200	μA
V _{IH}	Input High Voltage	Pin: $\overline{\text{MR}}$, WDI	0.7V _{CC}	-	-	V
V _{IL}	Input Low Voltage	Pin: $\overline{\text{MR}}$, WDI	-	-	0.3V _{CC}	V
V _{RST}	Reset Threshold Voltage (Note 2)	T _A = 25°C	V _{RN} - 1.5%	V _{RN}	V _{RN} + 1.5%	V
		75x1	4.560	4.630	4.699	
		75x2	4.314	4.380	4.446	
		75x3	3.034	3.080	3.126	
		75x4	2.886	2.930	2.974	
		75x5	2.590	2.630	2.669	
V _{RTH+}	Reset Threshold Voltage (Note 2)	V _{CC} Varies between V _{RN} - 5%	-	70	-	mV
V _{OH}	Output High Voltage	V _{CC} ≥ 4.5V I _{source} = 800μA	V _{CC} - 1.5	-	-	V
		V _{CC} ≥ 2.7V I _{source} = 500μA	0.8 × V _{CC}	-	-	
		V _{CC} ≥ 1.8V I _{source} = 150μA	0.8 × V _{CC}	-	-	
V _{OL}	Output Low Voltage	V _{CC} ≥ 4.5V I _{sink} = 3.2mA	-	-	0.4	V
		V _{CC} ≥ 2.7V I _{sink} = 1.2mA	-	-	0.3	
		V _{CC} ≥ 1.2V I _{sink} = 100μA	-	-	0.3	

Symbol	Description	Test Conditions	Min.	Typ.	Max.	Unit
V _{PFI}	PFI Input Threshold	V _{PFI} varies from 1.0V to 1.5V	1.23	1.25	1.27	V
		V _{PFI} varies from 0V to 1.0V	1.20	1.25	1.30	
I _{PFI}	PFI Input Current	PFI connected to V _{CC}	-	-	2.00	μA
		PFI connected to GND	-2.00	-	-	
I _{WDI}	Average WDI Input Current (Note 3)	WDI connected to V _{CC}	-	30	100	μA
		WDI connected to GND	-100	-30	-	
I _{MR}	$\overline{\text{MR}}$ input Current	$\overline{\text{MR}}=0, V_{CC} = 5V$	-600	-250	-100	μA

Note: 1. Parameters of room temperature guaranteed by production test and parameters of full-temperature guaranteed by design.

2. Valid for both $\overline{\text{RESET}}$ and $\overline{\text{RESET}}$. V_{RST} is the Reset threshold voltage when V_{CC} from high to low level, V_{RN} is nominal reset threshold voltage.

3. WDI is internally serviced within the watchdog period if WDI is left unconnected.

AC Electrical Characteristics

Symbol	Description	Test Conditions	Min	Typ	Max	Unit
t _{RS}	Reset Pulse Width	$\overline{\text{MR}}$ from low to High, T _A =25°C	160	200	280	ms
t _{WD}	Watchdog Timeout Period	WDI, $\overline{\text{MR}}$ tied to V _{CC} , V _{CC} >V _{RN} +5% , T _A =25°C	1.2	1.6	2.25	s
t _{MR}	$\overline{\text{MR}}$ Pulse Width	-	200	-	-	ns
t _{MD}	$\overline{\text{MR}}$ to RESET Delay	V _{CC} =5V	-	-	250	ns
t _{WP}	WDI Pulse Width	-	150	-	-	ns

Watchdog Timing Diagram

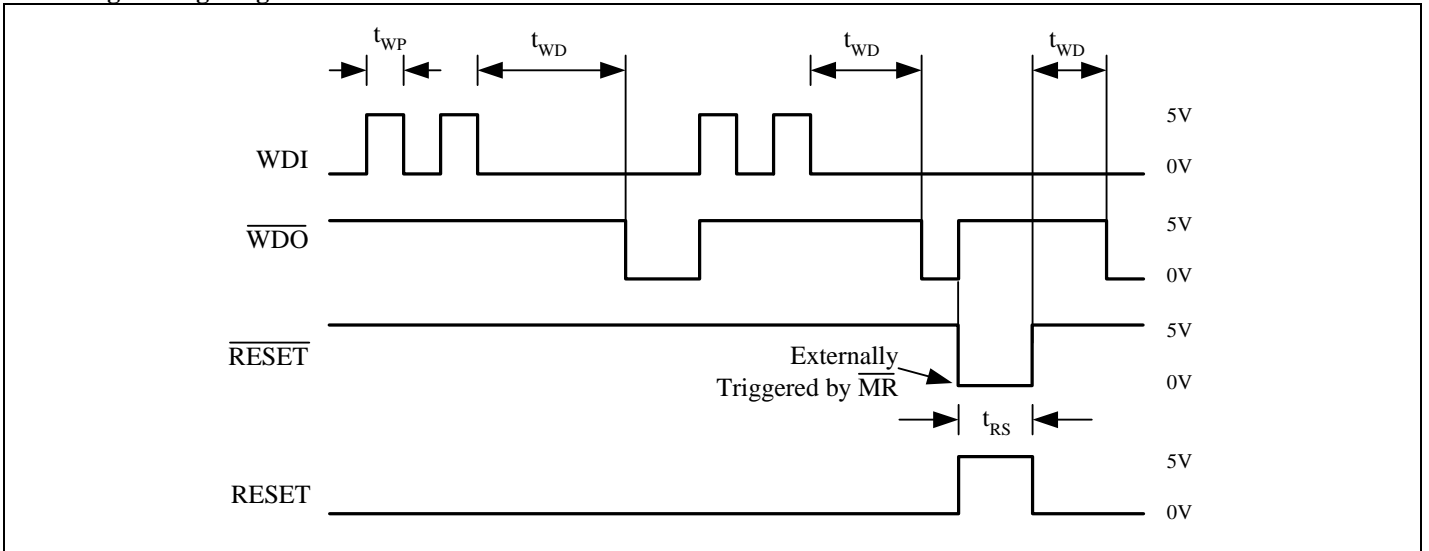

Watchdog Timing Diagram

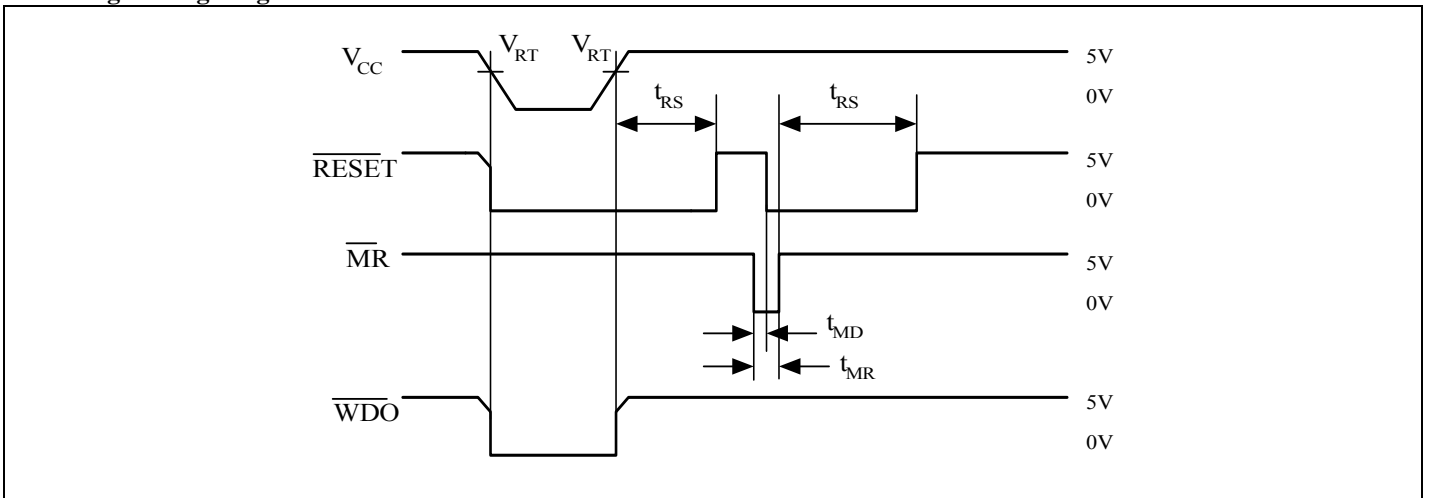

Functional Description

The PT75xx family can assert reset output during power-up, power-down and brownout conditions for μ P system, detect power failure or low-battery conditions with a 1.25V threshold detector and have watchdog functions. Refer to Function Table of PT7A75xx Family for their individual features. The typical application see Figure 4.

Reset Output

The supervisory circuits can assert reset for a microprocessor during power-up, power-down and brownout to prevent code execution errors.

On power-up, once V_{CC} reaches about 1.2V, $\overline{\text{RESET}}$ is a guaranteed logic low of 0.4V or less. As V_{CC} rises, $\overline{\text{RESET}}$ stays low. When V_{CC} rises above the reset threshold, an internal timer releases $\overline{\text{RESET}}$ after about 200ms. $\overline{\text{RESET}}$ pulses low whenever V_{CC} drops below the reset threshold, i.e. brownout condition. If brownout occurs in the middle of a previously initiated reset pulse, the pulse continues for at least another 140ms. On power-down, once V_{CC} falls below the reset threshold, $\overline{\text{RESET}}$ stays low and is guaranteed to be 0.4V or less until V_{CC} drops below 1.0V.

The PT7A752x and PT7A753x active-high $\overline{\text{RESET}}$ output is simply the inverse of the $\overline{\text{RESET}}$ output, and is guaranteed to be valid with V_{CC} down to 1.2V. Some μ Ps, such as Intel's 80C51, require an active-high reset pulse.

Watchdog Timer

The watchdog circuit monitors the μ P activity. If the μ P does not toggle the watchdog input (WDI) within 1.6sec and WDI is not in high impedance, $\overline{\text{WDO}}$ goes low. As long as $\overline{\text{RESET}}$ is asserted or the WDI input is in high impedance, the watchdog timer will stay cleared and will not count. As soon as reset is released and WDI is driven high or low, the timer will start counting. Pulses as short as 50ns can be detected.

Typically, $\overline{\text{WDO}}$ will be connected to the non-maskable interrupt input (NMI) of a μ P. When V_{CC} drops below the reset threshold, $\overline{\text{WDO}}$ will go low whether or not the watchdog timer has timed out yet. Normally this would trigger an NMI interrupt, but $\overline{\text{RESET}}$ goes low simultaneously, and thus overrides the NMI interrupt. If WDI is left unconnected, $\overline{\text{WDO}}$ can be used as a low-line output. Since floating WDI disables the internal timer, $\overline{\text{WDO}}$ goes low only when V_{CC} falls below the reset threshold, thus functioning as a low-line output.

Manual Reset

The manual-reset input ($\overline{\text{MR}}$) allows reset to be triggered by a push button switch. The switch is effectively debounced by the 140ms minimum reset pulse width. $\overline{\text{MR}}$ is TTL/CMOS logic compatible, so it can be driven by any logic reset output.

Power-Fail Comparator

The power-fail comparator will send out a Low signal once detects a voltage lowered than 1.25V. It can be used for various purposes because its output and non-inverting input are not internally connected. The inverting input is internally connected to a 1.25V reference.

Typical Application Circuit

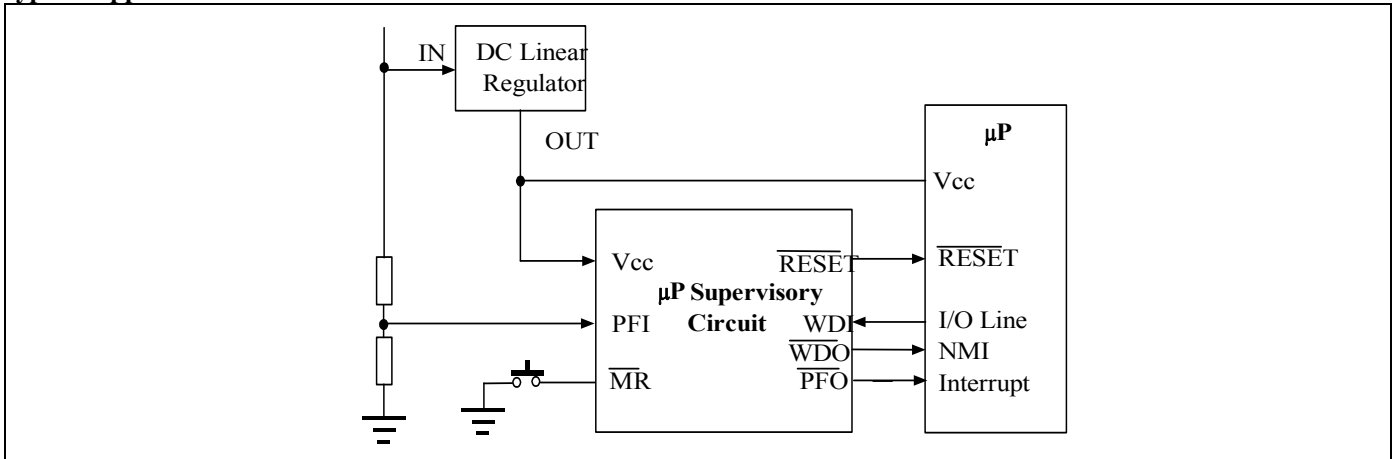

Part Marking

Top mark not available at this time. To obtain advance information regarding the top mark, please contact your local sales representative.

Packaging Mechanical
8-SOIC (W)

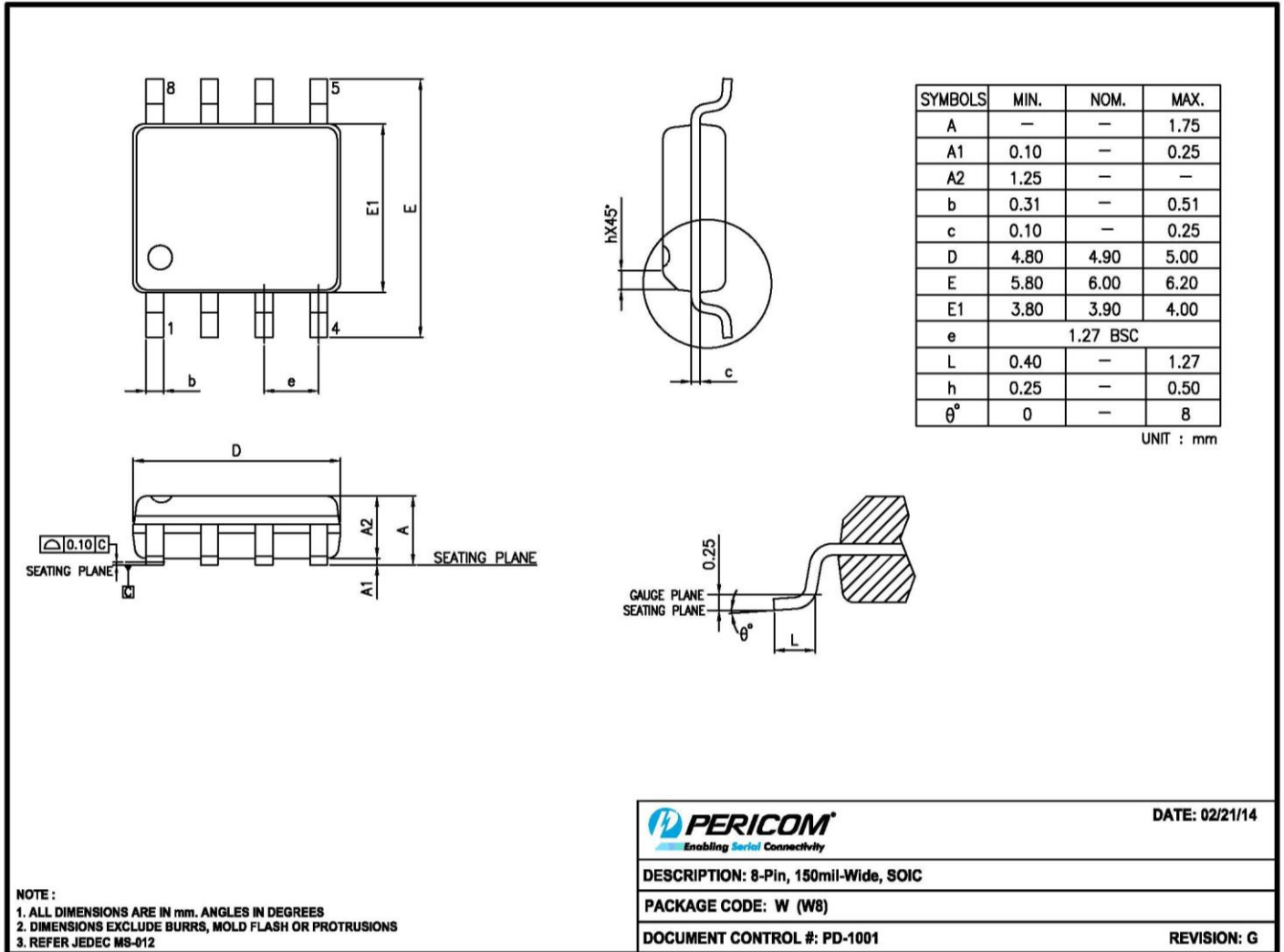

For latest package info.

please check: <http://www.diodes.com/design/support/packaging/pericom-packaging/packaging-mechanicals-and-thermal-characteristics/>

Ordering Information

Part Number	Package Code	Package Description
PT7A751xWEX	W	8-Pin, 150mil-Wide (SOIC)
PT7A752xWEX	W	8-Pin, 150mil-Wide (SOIC)
PT7A753xWEX	W	8-Pin, 150mil-Wide (SOIC)

Notes:

- “x” refers to voltage range, see below *Function Comparison Table*.
- No purposely added lead. Fully EU Directive 2002/95/EC (RoHS), 2011/65/EU (RoHS 2) & 2015/863/EU (RoHS 3) compliant.
- See <https://www.diodes.com/quality/lead-free/> for more information about Diodes Incorporated’s definitions of Halogen- and Antimony-free, "Green" and Lead-free.
- Halogen- and Antimony-free "Green" products are defined as those which contain <900ppm bromine, <900ppm chlorine (<1500ppm total Br + Cl) and <1000ppm antimony compounds.
- E = Pb-free and Green
- X suffix = Tape/Reel

Function Comparison Table

Part No.	Reset Threshold	Reset Active Low or High	Nom. Reset Time (ms), t_{RS}	Nom. Watch dog Time (sec), t_{WD}	Power Fail Comp.	Manual Reset Input
PT7A7511	4.63V	LOW	200	1.6	1.25V detector	Yes
PT7A7521	4.63V	HIGH	200	1.6	1.25V detector	Yes
PT7A7531	4.63V	LOW, HIGH	200	unavailable	1.25V detector	Yes
PT7A7512	4.38V	LOW	200	1.6	1.25V detector	Yes
PT7A7522	4.38V	HIGH	200	1.6	1.25V detector	Yes
PT7A7532	4.38V	LOW, HIGH	200	unavailable	1.25V detector	Yes
PT7A7513	3.08V	LOW	200	1.6	1.25V detector	Yes
PT7A7523	3.08V	HIGH	200	1.6	1.25V detector	Yes
PT7A7533	3.08V	LOW, HIGH	200	unavailable	1.25V detector	Yes
PT7A7514	2.93V	LOW	200	1.6	1.25V detector	Yes
PT7A7524	2.93V	HIGH	200	1.6	1.25V detector	Yes
PT7A7534	2.93V	LOW, HIGH	200	unavailable	1.25V detector	Yes
PT7A7515	2.63V	LOW	200	1.6	1.25V detector	Yes
PT7A7525	2.63V	HIGH	200	1.6	1.25V detector	Yes
PT7A7535	2.63V	LOW, HIGH	200	unavailable	1.25V detector	Yes

IMPORTANT NOTICE

DIODES INCORPORATED MAKES NO WARRANTY OF ANY KIND, EXPRESS OR IMPLIED, WITH REGARDS TO THIS DOCUMENT, INCLUDING, BUT NOT LIMITED TO, THE IMPLIED WARRANTIES OF MERCHANTABILITY AND FITNESS FOR A PARTICULAR PURPOSE (AND THEIR EQUIVALENTS UNDER THE LAWS OF ANY JURISDICTION).

Diodes Incorporated and its subsidiaries reserve the right to make modifications, enhancements, improvements, corrections or other changes without further notice to this document and any product described herein. Diodes Incorporated does not assume any liability arising out of the application or use of this document or any product described herein; neither does Diodes Incorporated convey any license under its patent or trademark rights, nor the rights of others. Any Customer or user of this document or products described herein in such applications shall assume all risks of such use and will agree to hold Diodes Incorporated and all the companies whose products are represented on Diodes Incorporated website, harmless against all damages.

Diodes Incorporated does not warrant or accept any liability whatsoever in respect of any products purchased through unauthorized sales channel.

Should Customers purchase or use Diodes Incorporated products for any unintended or unauthorized application, Customers shall indemnify and hold Diodes Incorporated and its representatives harmless against all claims, damages, expenses, and attorney fees arising out of, directly or indirectly, any claim of personal injury or death associated with such unintended or unauthorized application.

Products described herein may be covered by one or more United States, international or foreign patents pending. Product names and markings noted herein may also be covered by one or more United States, international or foreign trademarks.

This document is written in English but may be translated into multiple languages for reference. Only the English version of this document is the final and determinative format released by Diodes Incorporated.

LIFE SUPPORT

Diodes Incorporated products are specifically not authorized for use as critical components in life support devices or systems without the express written approval of the Chief Executive Officer of Diodes Incorporated. As used herein:

A. Life support devices or systems are devices or systems which:

1. are intended to implant into the body, or
2. support or sustain life and whose failure to perform when properly used in accordance with instructions for use provided in the labeling can be reasonably expected to result in significant injury to the user.

B. A critical component is any component in a life support device or system whose failure to perform can be reasonably expected to cause the failure of the life support device or to affect its safety or effectiveness.

Customers represent that they have all necessary expertise in the safety and regulatory ramifications of their life support devices or systems, and acknowledge and agree that they are solely responsible for all legal, regulatory and safety-related requirements concerning their products and any use of Diodes Incorporated products in such safety-critical, life support devices or systems, notwithstanding any devices- or systems-related information or support that may be provided by Diodes Incorporated. Further, Customers must fully indemnify Diodes Incorporated and its representatives against any damages arising out of the use of Diodes Incorporated products in such safety-critical, life support devices or systems.







Copyright © 2020, Diodes Incorporated
www.diodes.com

Looking for pricing, stock, or lifecycle information?

Click below to explore more details on WIN SOURCE:

-  [View PT7A7533WE on WIN SOURCE](#)
-  [Diodes Incorporated Information](#)

Optimize Your Supply Chain with WIN SOURCE Solutions

-  Global Sourcing Solution
-  Obsolete Management
-  Cost Control Management
-  Shortage Management
-  Alternative Solution
-  Excess Inventory Management