



**THE DATASHEET OF
PT7M6315US29D1TBEX**



Description

The series is designed to monitor power supplies in μ P and digital systems. It provides excellent circuit reliability and low cost by eliminating external components and adjustments, and a debounced manual reset input.

This device performs a single function: it asserts a reset signal whenever the V_{CC} supply voltage falls below a preset threshold or whenever manual reset is asserted. Reset remains asserted for an internally programmed interval (reset timeout period) after V_{CC} has risen above the reset threshold or manual reset is deasserted.

The DIODES PT7M6315USxx devices are open-drain RESET output. They can be pulled up to a voltage higher than V_{CC} .

The serials come with factory-trimmed, reset threshold voltages in 100mV increments from 1.8V to 5V. Preset timeout periods of 200ms (typ.) for PT7M6315USxxD3, 1570ms (typical) for PT7M6315USxxD4, and 26ms for PT7M6315USxxD2 are available.

Features

- Highly Accurate: $\pm 1.5\%$ (25°C)
- Detect Voltage Range: 1.8V to 5V in 100mV Increments
- Operating Voltage Range: 1.0V ~ 5.5V
- Operating Temperature Range: -40°C to +85°C
- Detect Voltage Temperature Characteristics: $\pm 2.5\% \times$ TYPICAL
- Output Configuration: N-Channel Open Drain
- Totally Lead-Free & Fully RoHS Compliant (Notes 1 & 2)
- Halogen and Antimony Free. "Green" Device (Note 3)
- For automotive applications requiring specific change control (i.e. parts qualified to AEC-Q100/101/104/200, PPAP capable, and manufactured in IATF 16949 certified facilities), please [contact us](mailto:contact_us) or your local Diodes representative.
<https://www.diodes.com/quality/product-definitions/>
- Three Reset Timeout Period Available:
 - Typical 1.6ms for PT7M6315USxxD1;
 - Typical 26ms for PT7M6315USxxD2;
 - Typical 200ms for PT7M6315USxxD3;
 - Typical 1570ms for PT7M6315USxxD4;
- Packaging (Pb-free & Green): 4-pin, SOT143 (TB)

Block Diagram

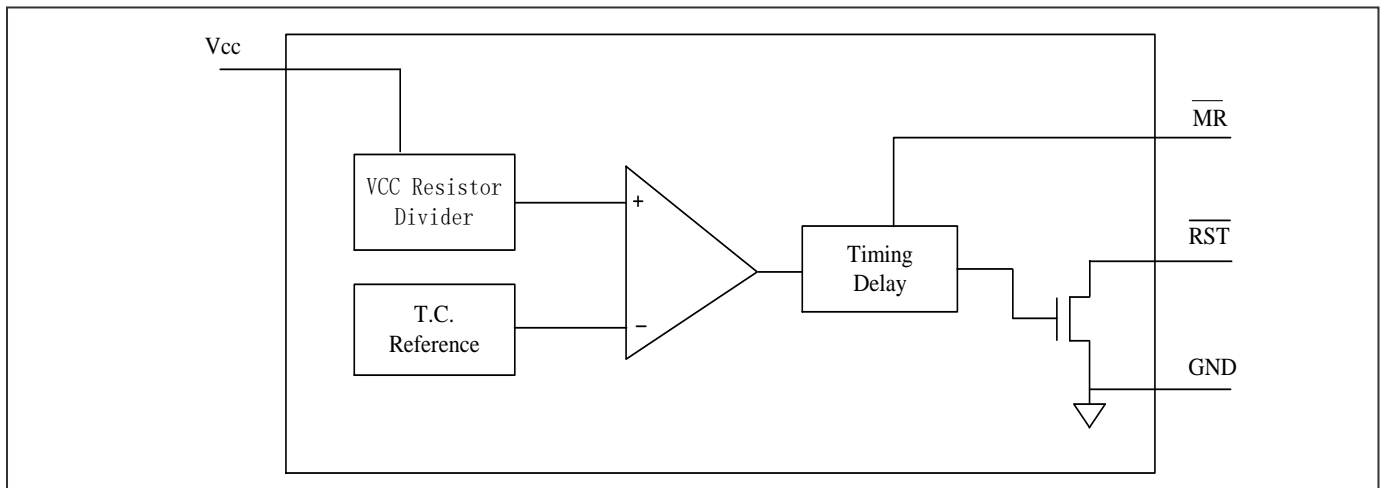

Notes:

1. No purposely added lead. Fully EU Directive 2002/95/EC (RoHS), 2011/65/EU (RoHS 2) & 2015/863/EU (RoHS 3) compliant.
2. See <https://www.diodes.com/quality/lead-free/> for more information about Diodes Incorporated's definitions of Halogen- and Antimony-free, "Green" and Lead-free.
3. Halogen- and Antimony-free "Green" products are defined as those which contain <900ppm bromine, <900ppm chlorine (<1500ppm total Br + Cl) and <1000ppm antimony compounds.

Pin Configuration

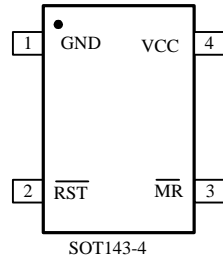

Pin Description

Name	Type	Description
$\overline{\text{RST}}$	I/O	Reset Output: $\overline{\text{RST}}$ is asserted when V_{CC} drops below voltage threshold V_{TH} . Active low.
$\overline{\text{MR}}$	I	Manual Reset: A logic low on $\overline{\text{MR}}$ asserts reset. Reset remains asserted as long as $\overline{\text{MR}}$ is low, and for the reset timeout period (t_{RS}) after the reset conditions are terminated. Connect to V_{CC} if not used.
GND	P	Ground
V_{CC}	P	Supply Voltage.

Function Description

Power Monitor

A microprocessor's (μP) reset input starts the μP in a known state. Whenever the μP is in an unknown state, it should be held in reset. The supervisory circuits assert reset during power-up and prevent code execution errors during power down or brownout conditions.

On power up, once V_{CC} reaches about 1.0V, $\overline{\text{RST}}$ is a guaranteed logic low of 0.4V or less. As V_{CC} rises, $\overline{\text{RST}}$ stays low. When V_{CC} rises above the reset threshold V_{RST} , an internal timer releases $\overline{\text{RST}}$ after about 200ms (PT7M6315USxxD3) or 1570ms (PT7M6315USxxD4) or 26ms (PT7M6315USxxD2) or 1.6ms (PT7M6315USxxD1). $\overline{\text{RST}}$ asserts whenever V_{CC} drops below the reset threshold, i.e. brownout condition. If brownout occurs in the middle of a previously initiated reset pulse, the pulse continues for at least another 200ms (PT7M6315USxxD3) or 1570ms (PT7M6315USxxD4) or 26ms (PT7M6315USxxD2) or 1.6ms (PT7M6315USxxD1). On power down, once V_{CC} falls below the reset threshold, $\overline{\text{RST}}$ stays low and is guaranteed to be 0.4V or less until V_{CC} drops below 1V.

Manual Reset

The manual-reset input ($\overline{\text{MR}}$) allows reset to be triggered by a push button switch. The switch is effectively debounced by the 1.6ms (PT7M6315USxxD1) or 26ms (PT7M6315USxxD2) or 200ms (PT7M6315USxxD3) or 1570ms (PT7M6315USxxD4) reset pulse width.

Maximum Ratings

Storage Temperature	-65°C to +150°C
Ambient Temperature with Power Applied.....	-40°C to +85°C
Supply Voltage to Ground Potential (V _{CC} to GND)	-0.3V to +7.0V
DC Input Voltage (All inputs except V _{CC} and GND).....	-0.3V to V _{CC} +0.3V
DC Output Current (All outputs)	30mA
Power Dissipation	320mW (Depend on package)

Note:

Stresses greater than those listed under MAXIMUM RATINGS may cause permanent damage to the device. This is a stress rating only and functional operation of the device at these or any other conditions above those indicated in the operational sections of this specification is not implied. Exposure to absolute maximum rating conditions for extended periods may affect reliability.

DC Electrical Characteristics

T_A = -40~85°C, unless otherwise noted. Typical values are at T_A = +25°C

Symbol	Description		Test Conditions	Min	Typ	Max	Unit
V _{CC}	Supply Voltage		—	1.0	—	5.5	V
I _{CC}	Supply Current		V _{CC} = 5.5V. No load.	—	—	12	μA
			V _{CC} = 3.6V. No load.	—	—	10	μA
V _{TH-}	Voltage Threshold		+25°C	(V _{TH-}) ×0.985	V _{TH-}	(V _{TH-}) ×1.015	V
			-40°C~85°C	(V _{TH-}) ×0.975	V _{TH-}	(V _{TH-}) ×1.025	—
V _{HYS}	Hysteresis		V _{TH+} - V _{TH-} *	—	50	-	mV
V _{OL}	Output Driving	Output Low	I _{OH} = 8mA, V _{CC} = 5V	—	—	0.4	V
			I _{OH} = 4mA, V _{CC} = 3V	—	—	0.3	
			I _{OH} = -50μA, V _{CC} = 1V	—	—	0.09	
I _{LKG}	Open-Drain Output Leakage Current		—	—	—	500	nA
R _P	Internal Pull-Up Resistor		\overline{MR}	32	63	100	kΩ
V _{IH}	Input High Voltage		V _{CC} < 4V	0.7×V _{CC}	—	—	V
			V _{CC} > 4V	2.4	—	—	
V _{IL}	Input Low Voltage		V _{CC} < 4V	—	—	0.3×V _{CC}	V
			V _{CC} > 4V	—	—	0.8	

Note: V_{TH-} is voltage threshold when V_{CC} falls from high to low. V_{TH+} is voltage threshold when V_{CC} rises from low to high.

AC Electrical Characteristics

Timing Diagram

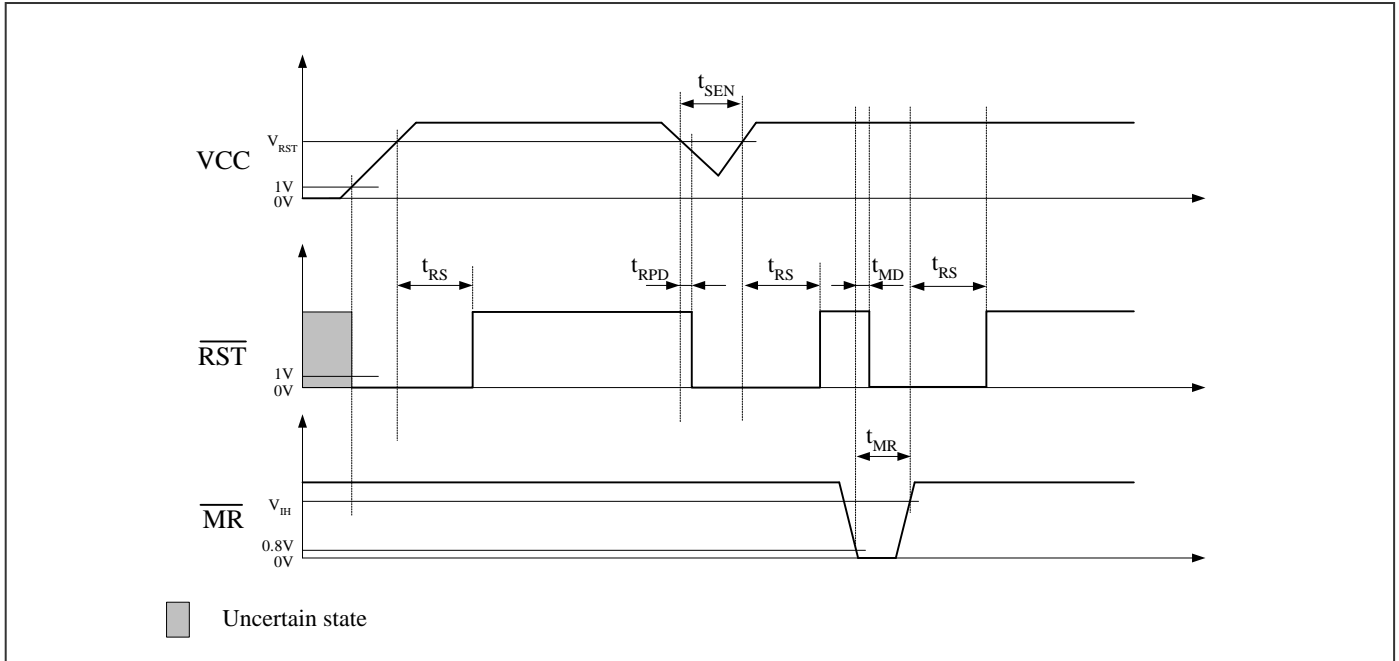

V_{CC} = 1.0V to 5.5V, T_A = -40~85°C, unless otherwise noted. Typical values are at T_A = +25°C

Symbol	Description	Test Conditions	Part No.	Min	Typ	Max	Unit
t _{RS}	Reset Timeout Period	—	6315USxxD1	1	1.6	2.2	ms
		—	6315USxxD2	17	26	40	ms
		—	6315USxxD3	140	200	280	ms
		—	6315USxxD4	1120	1570	2240	ms
t _{RPD}	Delay	—	—	17	—	μs	
t _{SEN}	Sensitivity	—	—	20	—	—	μs
t _{MD}	\overline{MR} to Reset Delay	—	—	—	500	—	ns
t _{MR}	\overline{MR} Pulse Width	—	—	1	—	—	μs

Packaging Mechanical

4-SOT143 (TB)

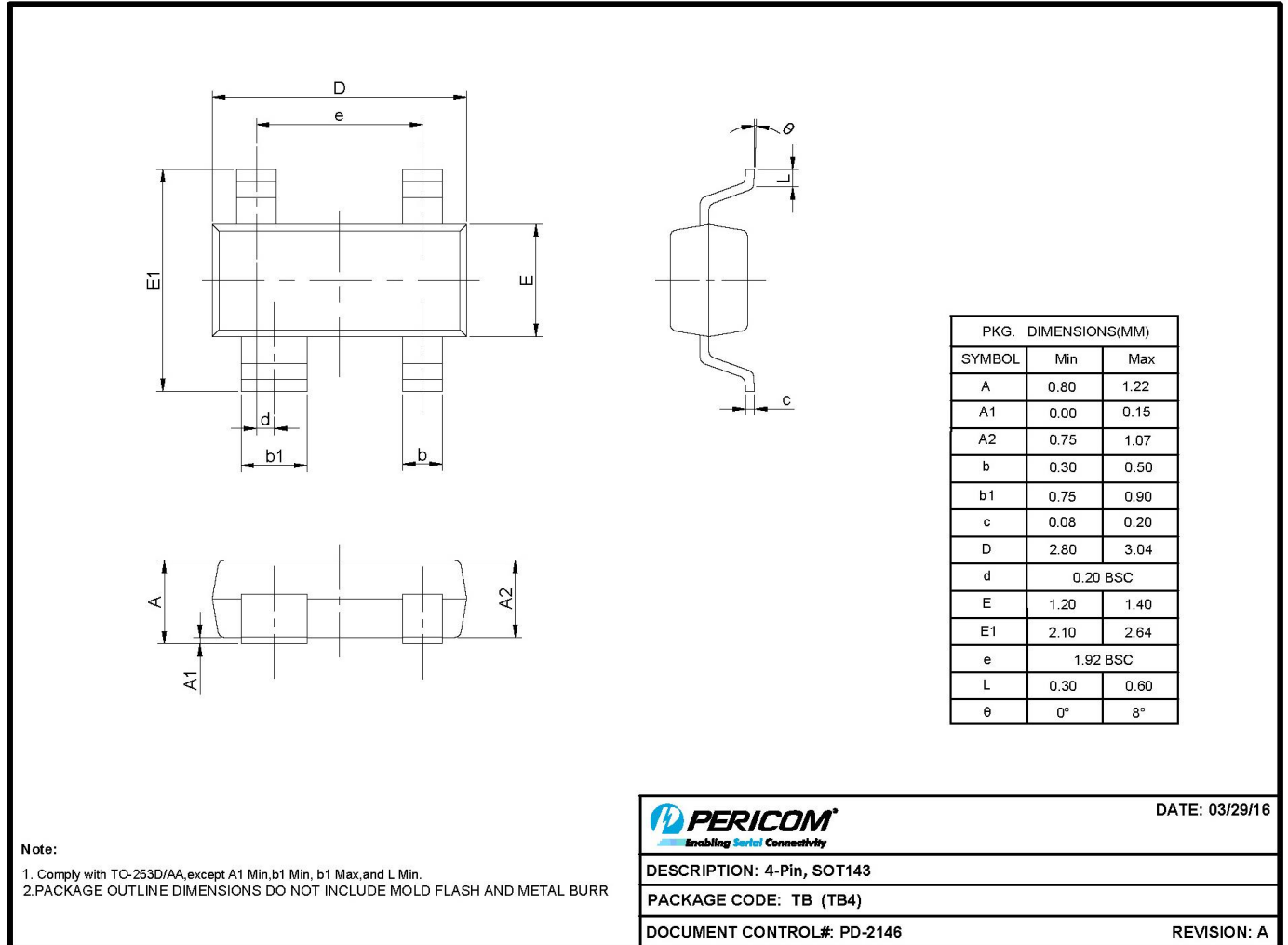

16-0083

For latest package information:

See <http://www.diodes.com/design/support/packaging/pericom-packaging/packaging-mechanicals-and-thermal-characteristics/>.

Ordering Information

Part Number	Package Code	Package Description	Status
PT7M6315USxxD1TBEX	TB	4-pin (SOT143)	Production part PT7M6315US29D1TBEX EOL for other D1 part number
PT7M6315USxxD2TBEX	TB	4-pin (SOT143)	EOL
PT7M6315USxxD3TBEX	TB	4-pin (SOT143)	EOL
PT7M6315USxxD4TBEX	TB	4-pin (SOT143)	EOL

Notes:

- No purposely added lead. Fully EU Directive 2002/95/EC (RoHS), 2011/65/EU (RoHS 2) & 2015/863/EU (RoHS 3) compliant.
- See <http://www.diodes.com/quality/lead-free/> for more information about Diodes Incorporated's definitions of Halogen- and Antimony-free, "Green" and Lead-free.
- Thermal characteristics can be found on the company web site at www.diodes.com/design/support/packaging/
- E = Pb-free and Green
- X suffix = Tape/Reel

Table 1. Suffix “xx” definition of PT7M6315USxx

Suffix xx	V _{TH} (V)	Suffix xx	V _{TH} (V)	Suffix xx	V _{TH} (V)	Suffix xx	V _{TH} (V)
18	1.8	27	2.7	36	3.6	45	4.5
19	1.9	28	2.8	37	3.7	46	4.6
20	2.0	29	2.9	38	3.8	47	4.7
21	2.1	30	3.0	39	3.9	48	4.8
22	2.2	31	3.1	40	4.0	49	4.9
23	2.3	32	3.2	41	4.1	50	5.0
24	2.4	33	3.3	42	4.2	—	—
25	2.5	34	3.4	43	4.3	—	—
26	2.6	35	3.5	44	4.4	—	—

SOT-143 Package Top Marking Instruction

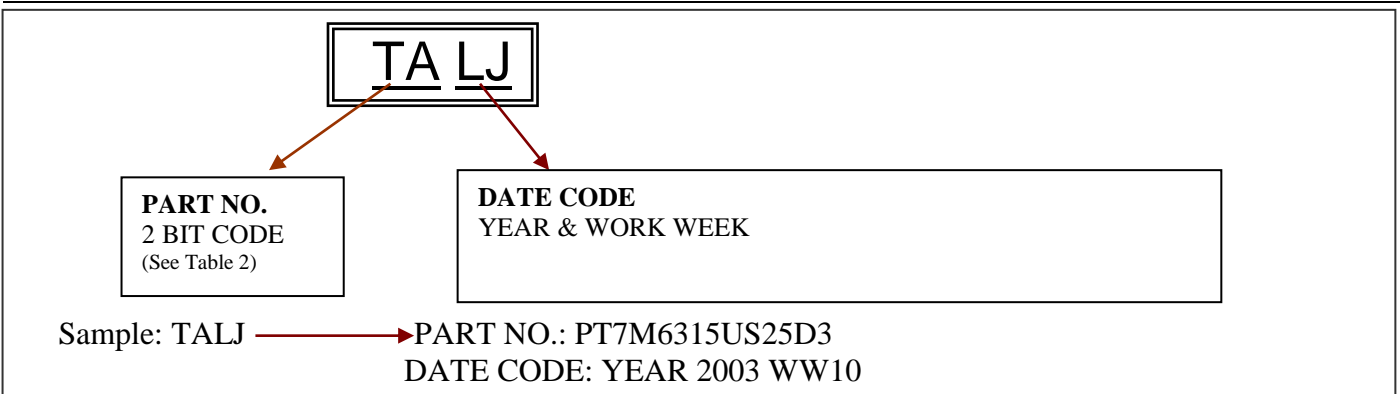

Table 2 Product Marking Code

Part No.	Code	Part No.	Code	Part No.	Code
PT7M6315US25D3	TA	PT7M6315US34D3	UK	PT7M6315US43D3	VU
PT7M6315US25D4	TB	PT7M6315US34D4	UL	PT7M6315US43D4	VV
PT7M6315US26D3	TE	PT7M6315US35D3	UO	PT7M6315US44D3	VY
PT7M6315US26D4	TF	PT7M6315US35D4	UP	PT7M6315US44D4	VZ
PT7M6315US27D3	TI	PT7M6315US36D3	US	PT7M6315US45D3	WC
PT7M6315US27D4	TJ	PT7M6315US36D4	UT	PT7M6315US45D4	WD
PT7M6315US28D3	TM	PT7M6315US37D3	UW	PT7M6315US46D3	WG
PT7M6315US28D4	TN	PT7M6315US37D4	UX	PT7M6315US46D4	WH
PT7M6315US29D3	TQ	PT7M6315US38D3	VA	PT7M6315US47D3	WK
PT7M6315US29D4	TR	PT7M6315US38D4	VB	PT7M6315US47D4	WL
PT7M6315US30D3	TU	PT7M6315US39D3	VE	PT7M6315US48D3	WO
PT7M6315US30D4	TV	PT7M6315US39D4	VF	PT7M6315US48D4	WP
PT7M6315US31D3	TY	PT7M6315US40D3	VI	PT7M6315US49D3	WS
PT7M6315US31D4	TZ	PT7M6315US40D4	VJ	PT7M6315US49D4	WT
PT7M6315US32D3	UC	PT7M6315US41D3	VM	PT7M6315US50D3	WW
PT7M6315US32D4	UD	PT7M6315US41D4	VN	PT7M6315US50D4	WX
PT7M6315US33D3	UG	PT7M6315US42D3	VQ	PT7M6315US29D2	pM
PT7M6315US33D4	UH	PT7M6315US42D4	VR	PT7M6315US30D2	pN
		PT7M6315US29D1	qK	PT7M6315US30D1	qL

IMPORTANT NOTICE

1. DIODES INCORPORATED (Diodes) AND ITS SUBSIDIARIES MAKE NO WARRANTY OF ANY KIND, EXPRESS OR IMPLIED, WITH REGARDS TO ANY INFORMATION CONTAINED IN THIS DOCUMENT, INCLUDING, BUT NOT LIMITED TO, THE IMPLIED WARRANTIES OF MERCHANTABILITY, FITNESS FOR A PARTICULAR PURPOSE OR NON-INFRINGEMENT OF THIRD PARTY INTELLECTUAL PROPERTY RIGHTS (AND THEIR EQUIVALENTS UNDER THE LAWS OF ANY JURISDICTION).
2. The Information contained herein is for informational purpose only and is provided only to illustrate the operation of Diodes' products described herein and application examples. Diodes does not assume any liability arising out of the application or use of this document or any product described herein. This document is intended for skilled and technically trained engineering customers and users who design with Diodes' products. Diodes' products may be used to facilitate safety-related applications; however, in all instances customers and users are responsible for (a) selecting the appropriate Diodes products for their applications, (b) evaluating the suitability of Diodes' products for their intended applications, (c) ensuring their applications, which incorporate Diodes' products, comply the applicable legal and regulatory requirements as well as safety and functional-safety related standards, and (d) ensuring they design with appropriate safeguards (including testing, validation, quality control techniques, redundancy, malfunction prevention, and appropriate treatment for aging degradation) to minimize the risks associated with their applications.
3. Diodes assumes no liability for any application-related information, support, assistance or feedback that may be provided by Diodes from time to time. Any customer or user of this document or products described herein will assume all risks and liabilities associated with such use, and will hold Diodes and all companies whose products are represented herein or on Diodes' websites, harmless against all damages and liabilities.
4. Products described herein may be covered by one or more United States, international or foreign patents and pending patent applications. Product names and markings noted herein may also be covered by one or more United States, international or foreign trademarks and trademark applications. Diodes does not convey any license under any of its intellectual property rights or the rights of any third parties (including third parties whose products and services may be described in this document or on Diodes' website) under this document.
5. Diodes' products are provided subject to Diodes' Standard Terms and Conditions of Sale (<https://www.diodes.com/about/company/terms-and-conditions/terms-and-conditions-of-sales/>) or other applicable terms. This document does not alter or expand the applicable warranties provided by Diodes. Diodes does not warrant or accept any liability whatsoever in respect of any products purchased through unauthorized sales channel.
6. Diodes' products and technology may not be used for or incorporated into any products or systems whose manufacture, use or sale is prohibited under any applicable laws and regulations. Should customers or users use Diodes' products in contravention of any applicable laws or regulations, or for any unintended or unauthorized application, customers and users will (a) be solely responsible for any damages, losses or penalties arising in connection therewith or as a result thereof, and (b) indemnify and hold Diodes and its representatives and agents harmless against any and all claims, damages, expenses, and attorney fees arising out of, directly or indirectly, any claim relating to any noncompliance with the applicable laws and regulations, as well as any unintended or unauthorized application.
7. While efforts have been made to ensure the information contained in this document is accurate, complete and current, it may contain technical inaccuracies, omissions and typographical errors. Diodes does not warrant that information contained in this document is error-free and Diodes is under no obligation to update or otherwise correct this information. Notwithstanding the foregoing, Diodes reserves the right to make modifications, enhancements, improvements, corrections or other changes without further notice to this document and any product described herein. This document is written in English but may be translated into multiple languages for reference. Only the English version of this document is the final and determinative format released by Diodes.
8. Any unauthorized copying, modification, distribution, transmission, display or other use of this document (or any portion hereof) is prohibited. Diodes assumes no responsibility for any losses incurred by the customers or users or any third parties arising from any such unauthorized use.
9. This Notice may be periodically updated with the most recent version available at <https://www.diodes.com/about/company/terms-and-conditions/important-notice>

The Diodes logo is a registered trademark of Diodes Incorporated in the United States and other countries.



All other trademarks are the property of their respective owners.

© 2023 Diodes Incorporated. All Rights Reserved.







www.diodes.com

Looking for pricing, stock, or lifecycle information?

Click below to explore more details on WIN SOURCE:

-  [View PT7M6315US29D1TBEX on WIN SOURCE](#)
-  [Diodes Incorporated Information](#)

Optimize Your Supply Chain with WIN SOURCE Solutions

-  Global Sourcing Solution
-  Obsolete Management
-  Cost Control Management
-  Shortage Management
-  Alternative Solution
-  Excess Inventory Management