



**THE DATASHEET OF  
PTFA080551F-V4-R250**





PTFA080551E  
PTFA080551F  
*green*  
Product

## Thermally-Enhanced High Power RF LDMOS FETs 55 W, 869 – 960 MHz

### Description

The PTFA080551E and PTFA080551F are 55-watt LDMOS FETs designed for EDGE and CDMA power amplifier applications in the 869 to 960 MHz band. Features include input matching and thermally-enhanced packages with slotted or earless flanges. Manufactured with Infineon's advanced LDMOS process, these devices provide excellent thermal performance and superior reliability.

PTFA080551E  
Package H-36265-2



PTFA080551F  
Package H-37265-2

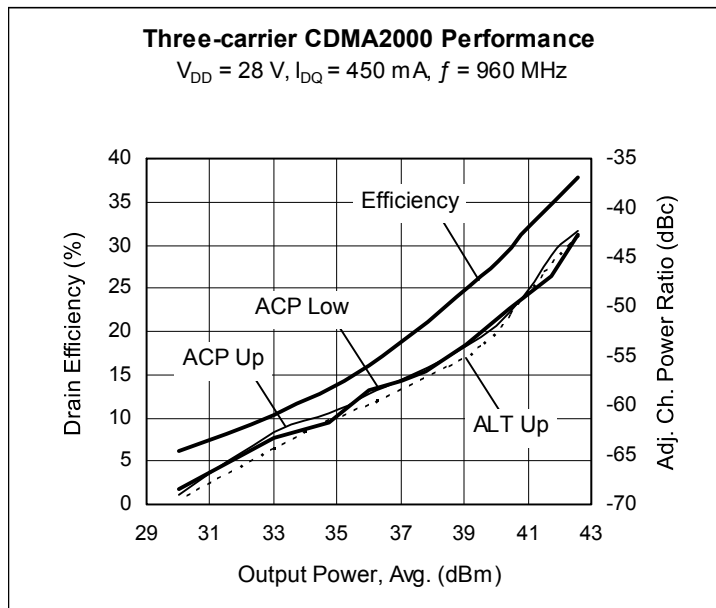

### Features

- Broadband internal matching
- Typical EDGE performance
  - Average output power = 26 W
  - Gain = 18 dB
  - Efficiency = 44%
- Typical CW performance
  - Output power at P-1dB = 75 W
  - Gain = 17 dB
  - Efficiency = 67%
- Integrated ESD protection: Human Body Model, Class 2 (minimum)
- Excellent thermal stability, low HCI drift
- Capable of handling 10:1 VSWR @ 28 V, 55 W (CW) output power
- Pb-free and RoHS compliant

### RF Characteristics

**EDGE Measurements** (not subject to production test—verified by design/characterization in Infineon test fixture)

$V_{DD} = 28\text{ V}$ ,  $I_{DQ} = 450\text{ mA}$ ,  $P_{OUT} = 26\text{ W AVG}$ ,  $f = 959.8\text{ MHz}$

Characteristic	Symbol	Min	Typ	Max	Unit
Error Vector Magnitude	EVM (RMS)	—	2.5	—	%
Modulation Spectrum @ 400 kHz	ACPR	—	-60	—	dBc
Modulation Spectrum @ 600 kHz	ACPR	—	-75	—	dBc
Gain	$G_{ps}$	—	18	—	dB
Drain Efficiency	$\eta_D$	—	44	—	%

All published data at  $T_{CASE} = 25^\circ\text{C}$  unless otherwise indicated

**ESD:** Electrostatic discharge sensitive device—observe handling precautions!

**RF Characteristics** (cont.)

**Two-tone Measurements** (tested in Infineon test fixture)

 $V_{DD} = 28\text{ V}$ ,  $I_{DQ} = 600\text{ mA}$ ,  $P_{OUT} = 55\text{ W PEP}$ ,  $f = 960\text{ MHz}$ , tone spacing = 1 MHz

Characteristic	Symbol	Min	Typ	Max	Unit
Gain	$G_{ps}$	18	18.5	—	dB
Drain Efficiency	$\eta_D$	46.5	48	—	%
Intermodulation Distortion	IMD	—	-31	-29	dBc

**DC Characteristics**

Characteristic	Conditions	Symbol	Min	Typ	Max	Unit
Drain-Source Breakdown Voltage	$V_{GS} = 0\text{ V}$ , $I_{DS} = 10\text{ }\mu\text{A}$	$V_{(BR)DSS}$	65	—	—	V
Drain Leakage Current	$V_{DS} = 28\text{ V}$ , $V_{GS} = 0\text{ V}$	$I_{DSS}$	—	—	1.0	$\mu\text{A}$
	$V_{DS} = 63\text{ V}$ , $V_{GS} = 0\text{ V}$	$I_{DSS}$	—	—	10.0	$\mu\text{A}$
On-State Resistance	$V_{GS} = 10\text{ V}$ , $V_{DS} = 0.1\text{ V}$	$R_{DS(on)}$	—	0.15	—	$\Omega$
Operating Gate Voltage	$V_{DS} = 28\text{ V}$ , $I_{DQ} = 450\text{ mA}$	$V_{GS}$	2.0	2.3	3.0	V
Gate Leakage Current	$V_{GS} = 10\text{ V}$ , $V_{DS} = 0\text{ V}$	$I_{GSS}$	—	—	1.0	$\mu\text{A}$

**Maximum Ratings**

Parameter	Symbol	Value	Unit
Drain-Source Voltage	$V_{DSS}$	65	V
Gate-Source Voltage	$V_{GS}$	-0.5 to +12	V
Junction Temperature	$T_J$	200	$^{\circ}\text{C}$
Total Device Dissipation	$P_D$	219	W
		Above 25 $^{\circ}\text{C}$ derate by	1.25
Storage Temperature Range	$T_{STG}$	-40 to +150	$^{\circ}\text{C}$
Thermal Resistance ( $T_{CASE} = 70^{\circ}\text{C}$ )	$R_{\theta JC}$	0.8	$^{\circ}\text{C/W}$

**Ordering Information**

Type and Version	Order Code	Package Description	Shipping
PTFA080551E V4 R0	PTFA080551EV4R0XTMA1	H-36265-2, bolt-down	Tape & Reel, 50 pcs
PTFA080551E V4 R250	PTFA080551EV4R250XTMA1	H-36265-2, bolt-down	Tape & Reel, 250 pcs
PTFA080551F V4 R0	PTFA080551FV4R0XTMA1	H-37265-2, earless flange	Tape & Reel, 50 pcs
PTFA080551F V4 R250	PTFA080551FV4R250XTMA1	H-37265-2, earless flange	Tape & Reel, 250 pcs

**Typical Performance** (data taken in a production test fixture)

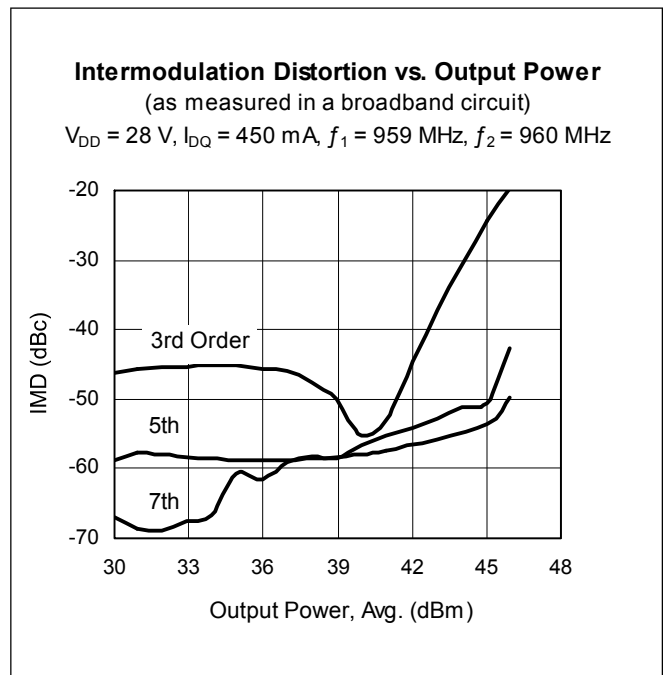
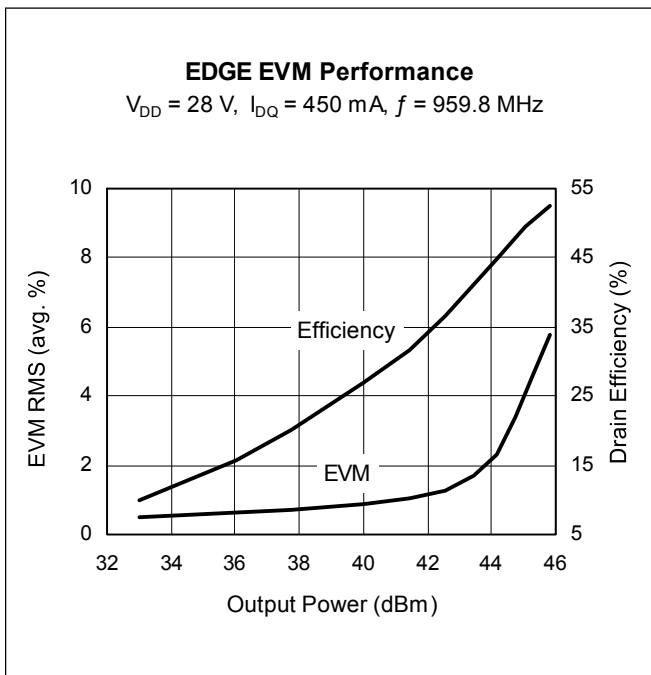
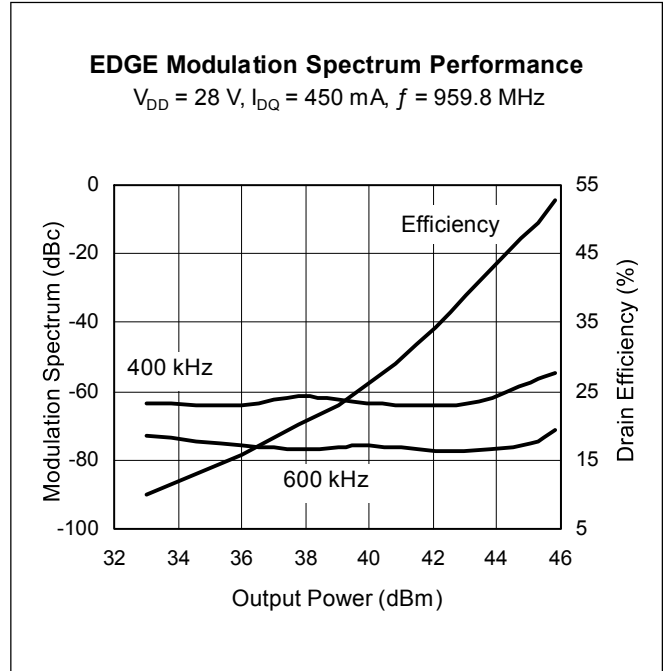
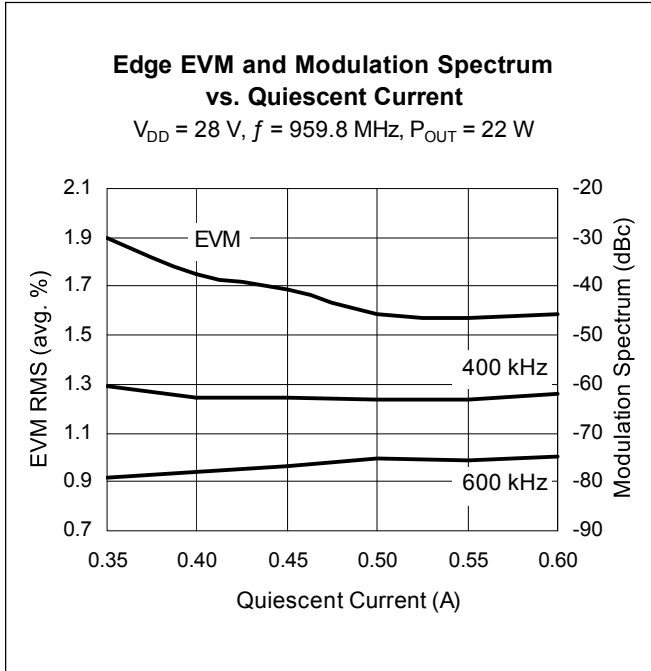

Typical Performance (cont.)

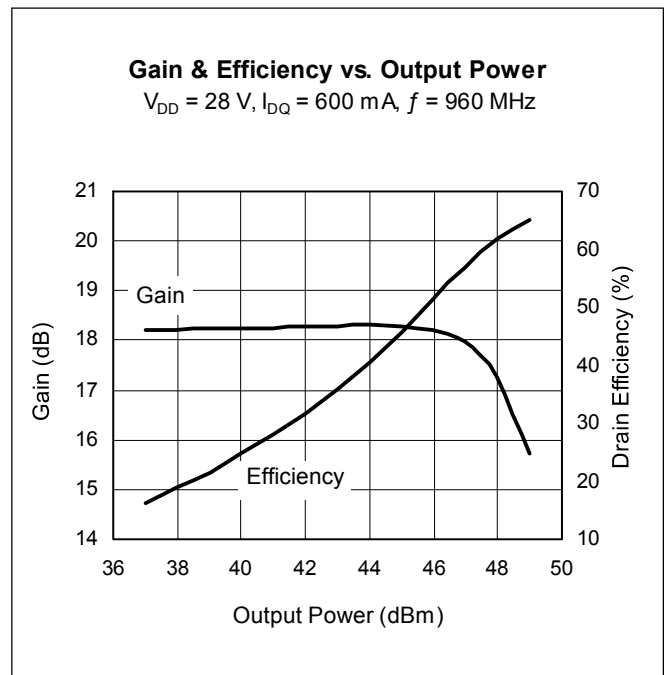
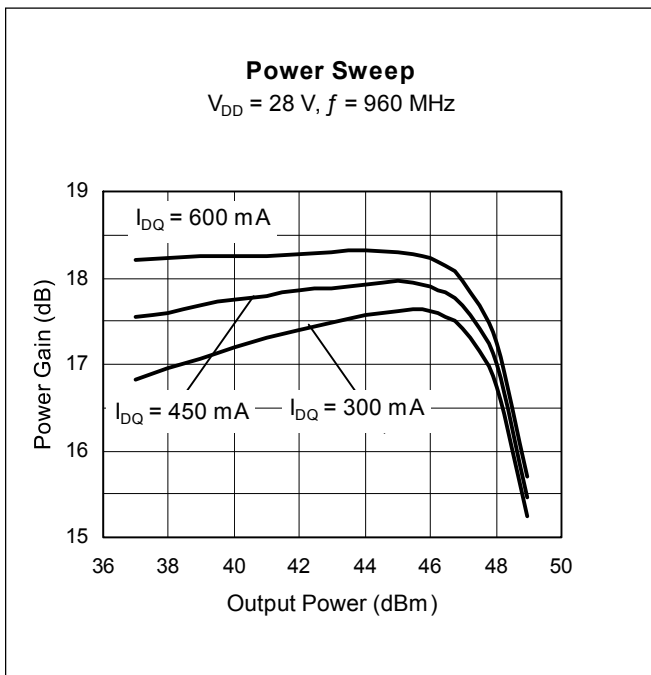
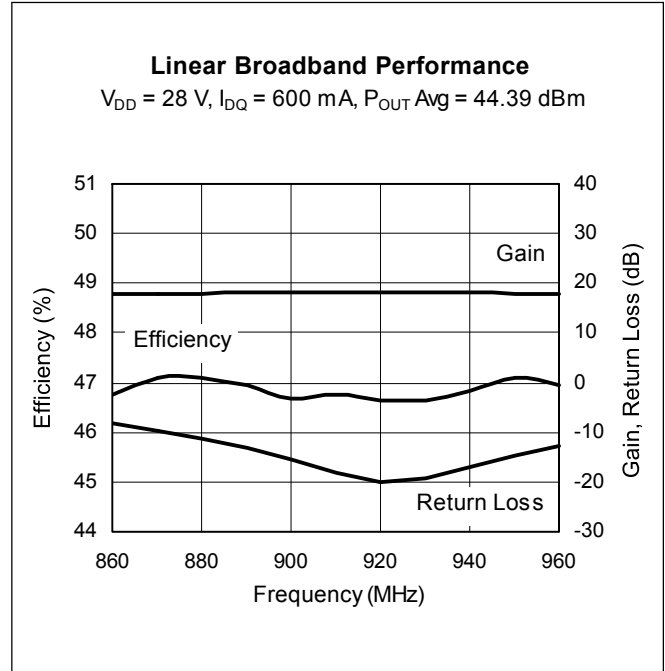
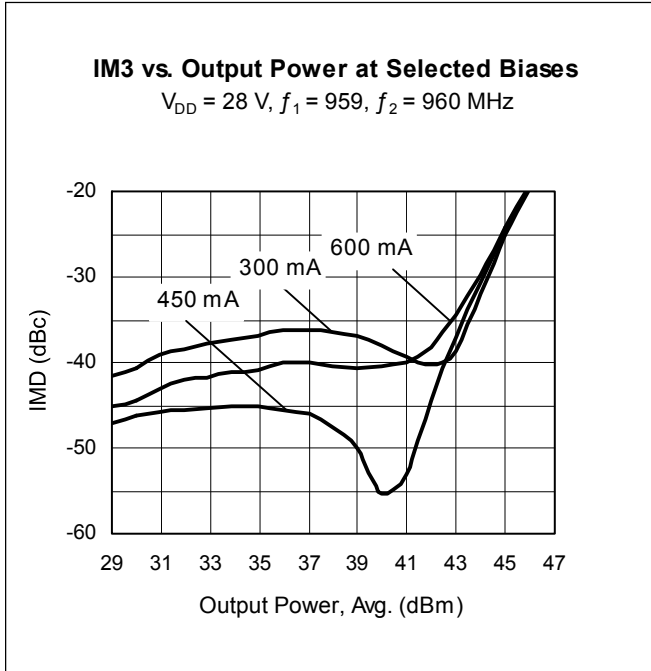

Typical Performance (cont.)

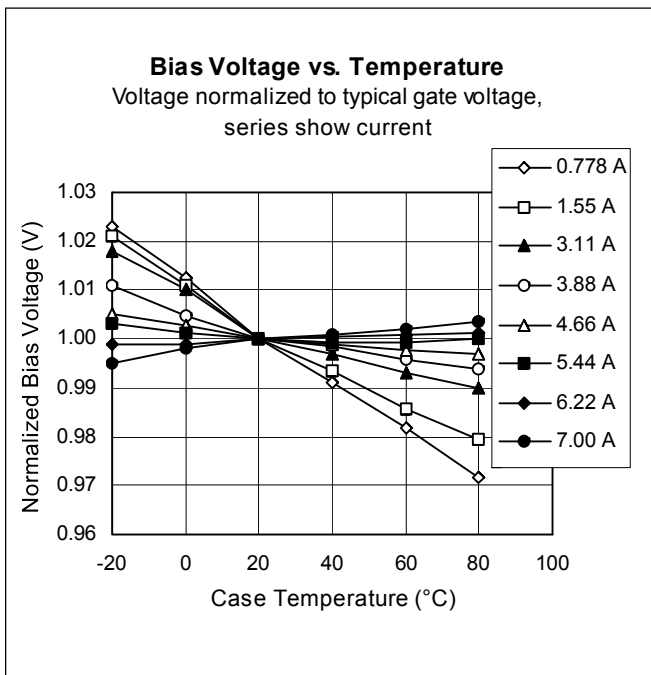
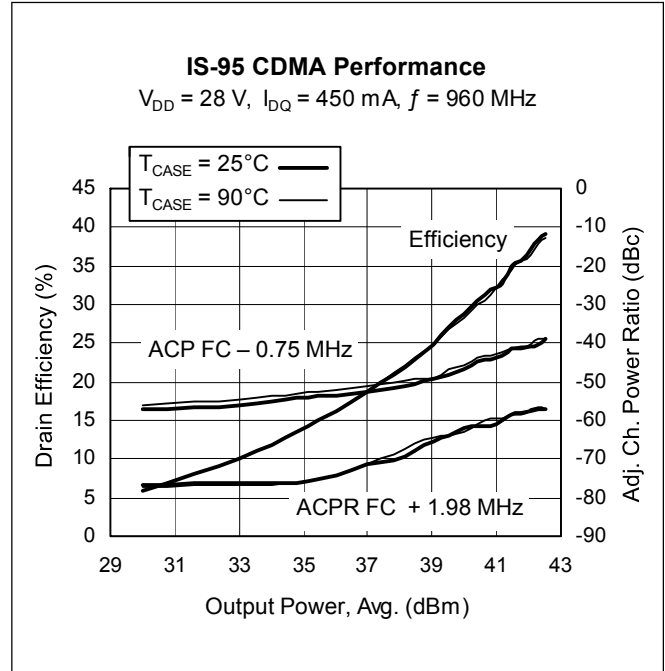
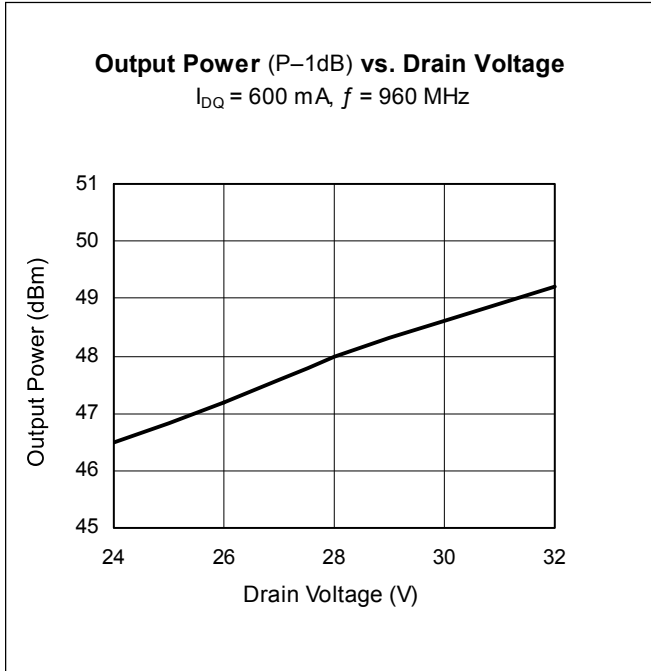

### Broadband Circuit Impedance

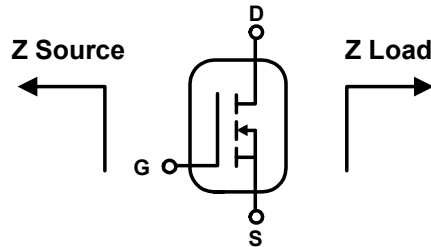

Frequency MHz	Z Source $\Omega$		Z Load $\Omega$	
	R	jX	R	jX
869	8.91	-10.93	7.42	-1.63
880	3.72	-8.28	4.65	-1.74
894	5.93	-5.43	4.61	0.16
920	4.87	-7.16	4.88	-0.59
960	6.05	-5.57	4.89	0.86

See next page for circuit information

## Reference Circuit

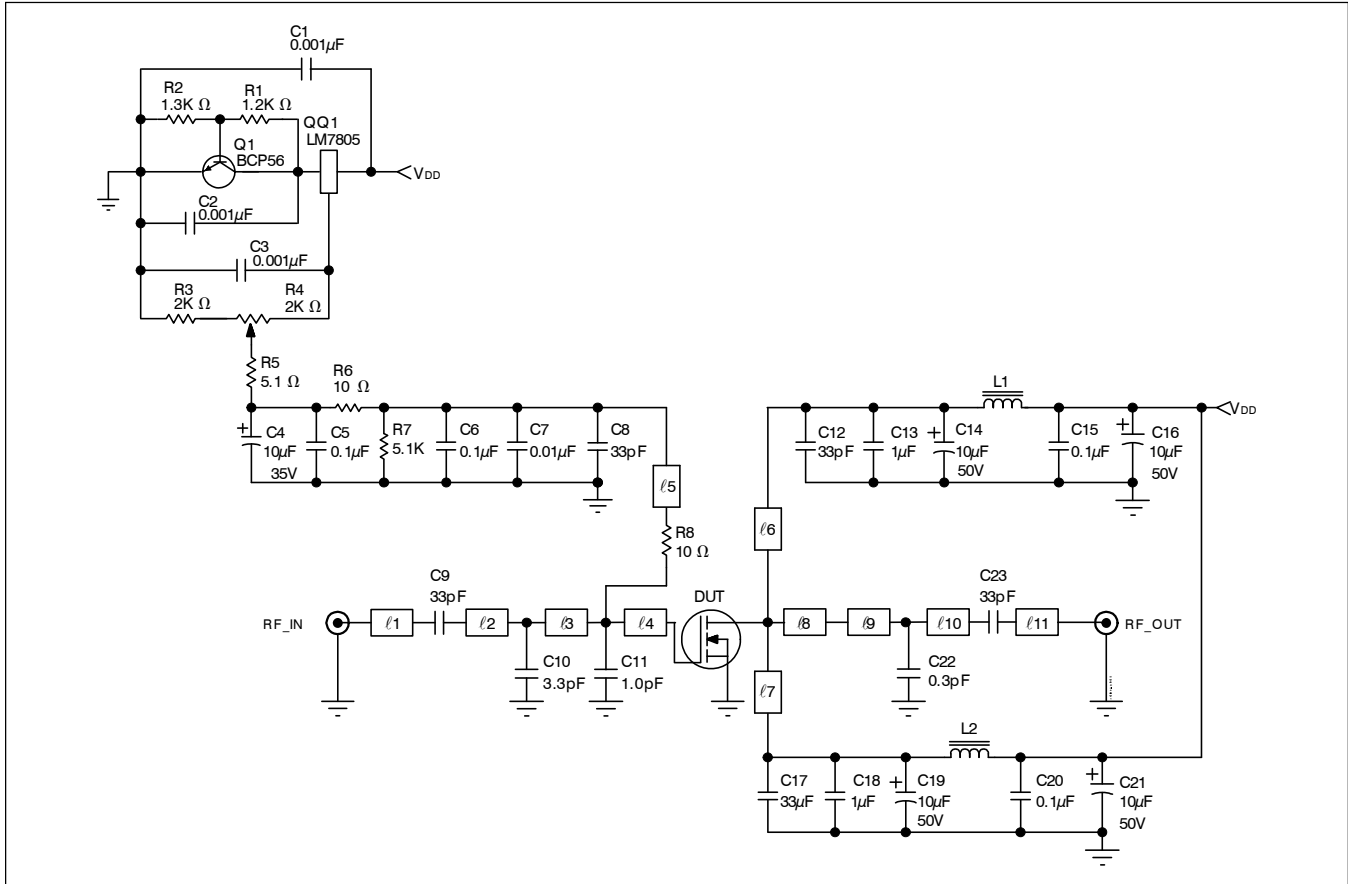

Reference circuit schematic diagram for  $f = 960 \text{ MHz}$

### Circuit Assembly Information

DUT	PTFA080551E or PTFA080551F	LDMOS Transistor	
PCB	0.76 mm [.030"] thick, $\epsilon_r = 4.5$	Rogers TMM4	2 oz. copper

Microstrip	Electrical Characteristics at 960 MHz <sup>1</sup>	Dimensions: L x W (mm)	Dimensions: L x W (in.)
$l_1$	0.070 $\lambda$ , 50.0 $\Omega$	12.19 x 1.37	0.480 x 0.054
$l_2$	0.122 $\lambda$ , 50.0 $\Omega$	20.93 x 1.37	0.824 x 0.054
$l_3$	0.031 $\lambda$ , 50.0 $\Omega$	5.31 x 1.37	0.209 x 0.054
$l_4$	0.063 $\lambda$ , 7.5 $\Omega$	9.58 x 16.21	0.377 x 0.638
$l_5$	0.162 $\lambda$ , 67.0 $\Omega$	28.45 x 0.79	1.120 x 0.031
$l_6, l_7$	0.150 $\lambda$ , 55.0 $\Omega$	25.65 x 1.17	1.010 x 0.046
$l_8$	0.198 $\lambda$ , 11.1 $\Omega$	30.73 x 10.46	1.210 x 0.412
$l_9$	0.145 $\lambda$ , 38.0 $\Omega$	24.21 x 2.16	0.953 x 0.085
$l_{10}$	0.009 $\lambda$ , 38.0 $\Omega$	1.52 x 2.16	0.060 x 0.085
$l_{11}$	0.026 $\lambda$ , 50.0 $\Omega$	4.50 x 1.37	0.177 x 0.054

<sup>1</sup>Electrical characteristics are rounded.

Reference Circuit (cont.)

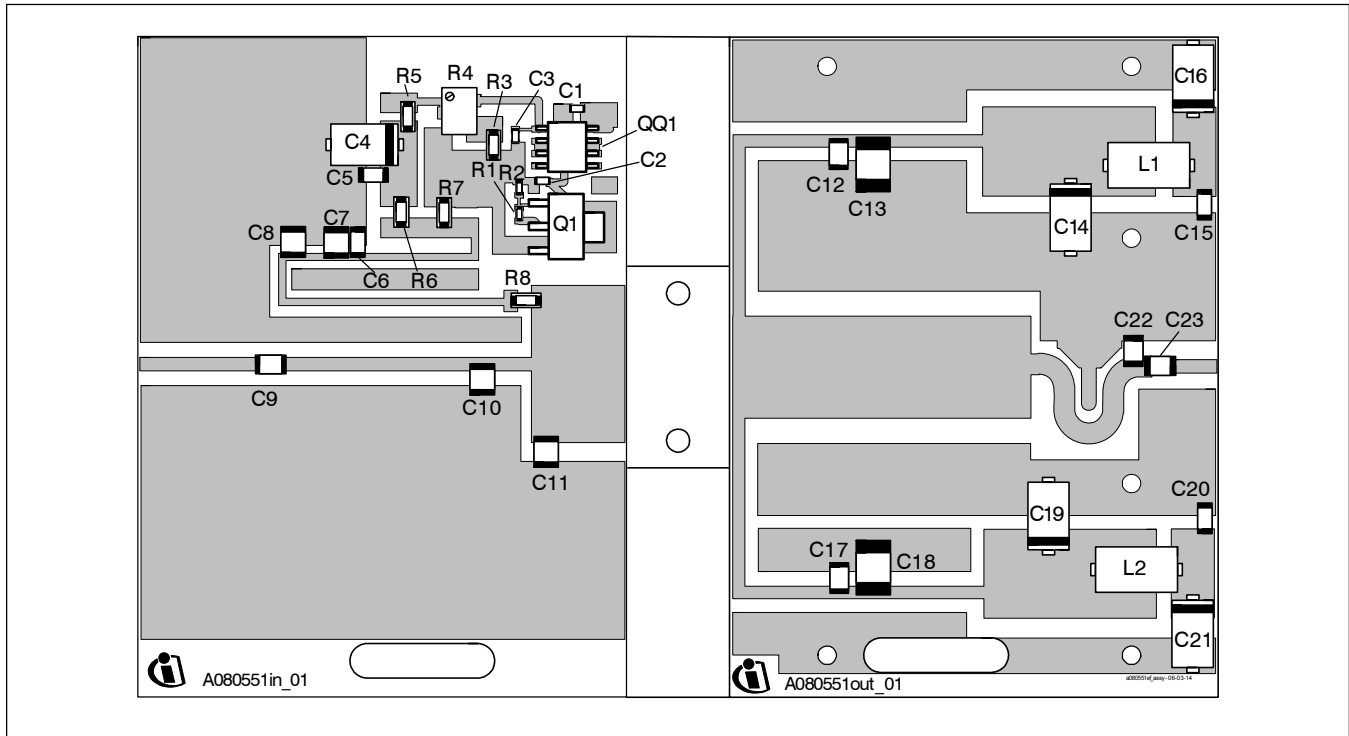

Reference circuit assembly diagram (not to scale)\*

Component	Description	Suggested Manufacturer	P/N or Comment
C1, C2, C3	Capacitor, 0.001 $\mu$ F	Digi-Key	PCC1772CT-ND
C4	Tantalum capacitor, 10 $\mu$ F, 35 V	Digi-Key	399-1655-2-ND
C5, C6, C15, C20	Capacitor, 0.1 $\mu$ F	Digi-Key	PCC104BCT-ND
C8, C9, C12, C17, C23	Ceramic capacitor, 33 pF	ATC	100B 330
C7	Capacitor, 0.01 $\mu$ F	ATC	200B 103
C10	Ceramic capacitor, 3.3 pF	ATC	100B 3R3
C11	Ceramic capacitor, 1.0 pF	ATC	100B 1R0
C13, C18	Capacitor, 1.0 $\mu$ F	ATC	920C105
C14, C16, C19, C21	Tantalum capacitor, 10 $\mu$ F, 50 V	Garrett Electronics	TPSE106K050R0400
C22	Ceramic capacitor, 0.3 pF	ATC	100B 0R3
L1, L2	Ferrite, 8.9 mm	Elna Magnetics	BDS 4.6/3/8.9-4S2
Q1	Transistor	Infineon Technologies	BCP56
QQ1	Voltage regulator	National Semiconductor	LM7805
R1	Chip Resistor 1.2 k-ohms	Digi-Key	P1.2KGCT-ND
R2	Chip Resistor 1.3 k-ohms	Digi-Key	P1.3KGCT-ND
R3	Chip Resistor 2 k-ohms	Digi-Key	P2KECT-ND
R4	Potentiometer 2 k-ohms	Digi-Key	3224W-202ETR-ND
R5, R7	Chip Resistor 5.1 k-ohms	Digi-Key	P5.1KECT-ND
R6, R8	Chip Resistor 10 ohms	Digi-Key	P10ECT-ND

\*Gerber Files for this circuit available on request

Confidential, Limited Internal Distribution

Package Outline Specifications

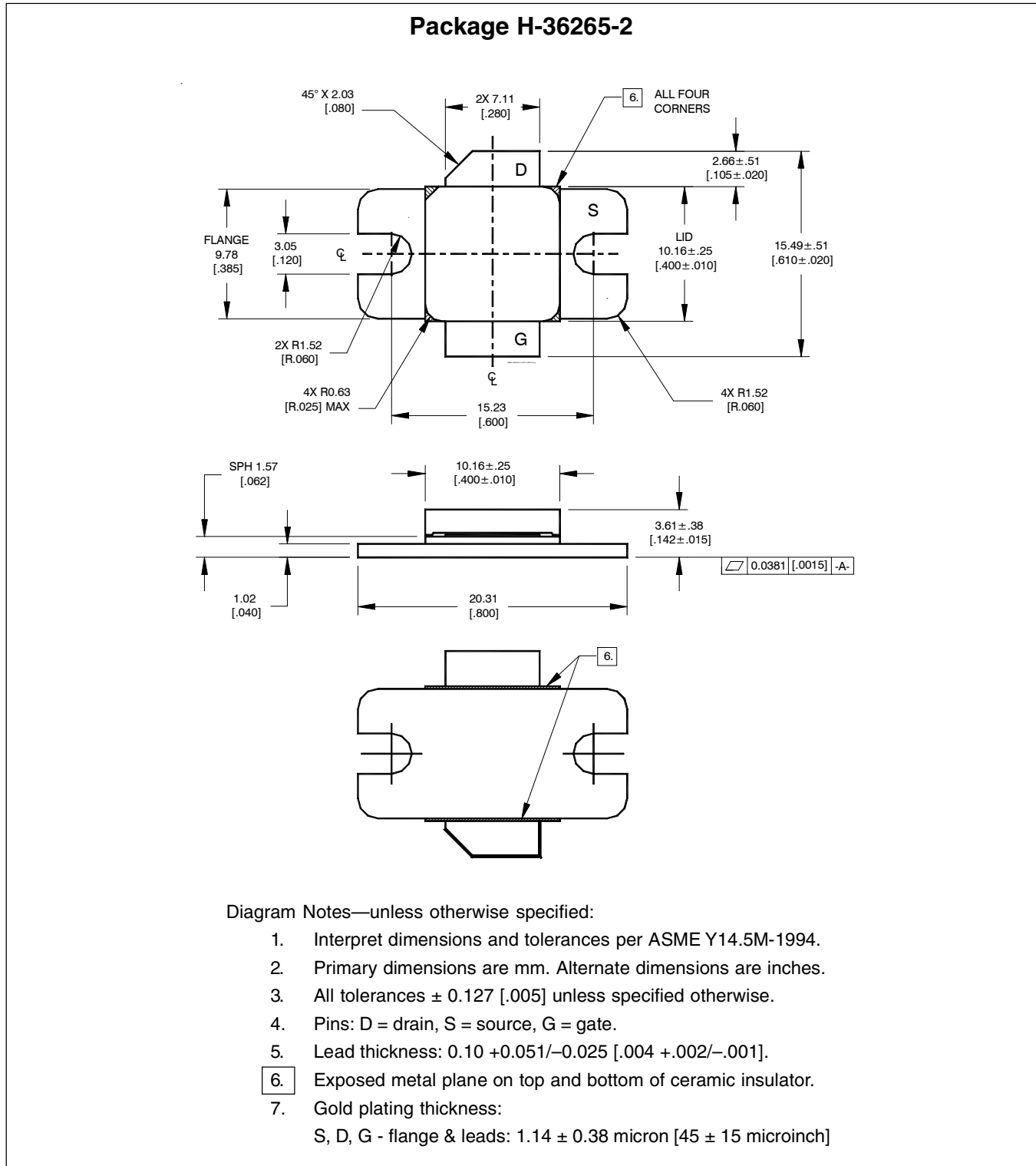

Confidential, Limited Internal Distribution

Package Outline Specifications (cont.)

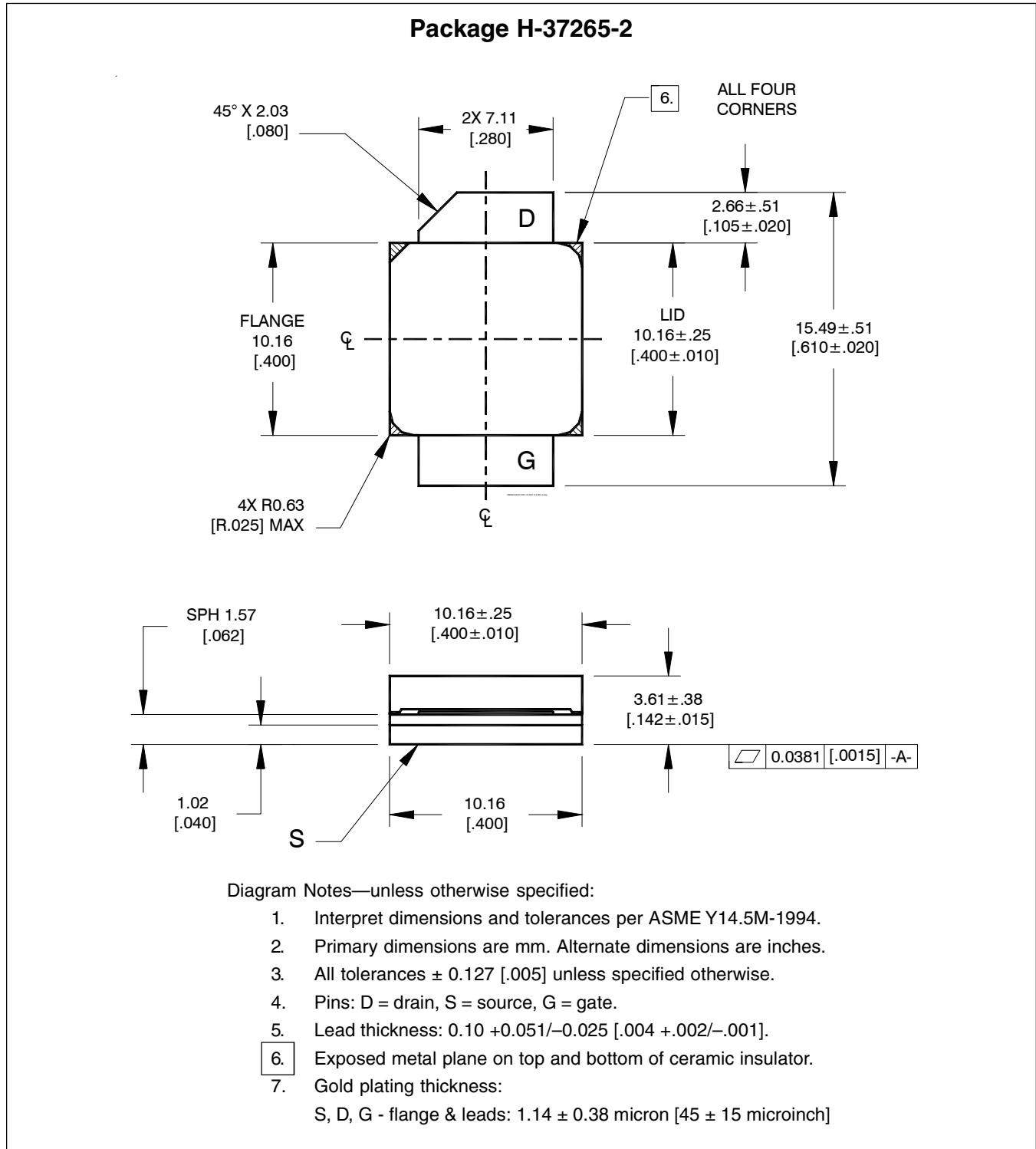

<b>Revision History:</b>	<b>2016-06-16</b>	Data Sheet
Previous Version:	2009-03-31, Data Sheet	
Page	Subjects (major changes since last revision)	
2	Update ordering information	

**We Listen to Your Comments**

Any information within this document that you feel is wrong, unclear or missing at all?

Your feedback will help us to continuously improve the quality of this document.

Please send your proposal (including a reference to this document) to:

[highpowerRF@infineon.com](mailto:highpowerRF@infineon.com)

To request other information, contact us at:

+1 877 465 3667 (1-877-GO-LDMOS) USA

or +1 408 776 0600 International

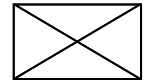

**Edition 2016-06-16**

**Published by**

**Infineon Technologies AG**

**81726 Munich, Germany**

**© 2009 Infineon Technologies AG**

**All Rights Reserved.**

**Legal Disclaimer**

The information given in this document shall in no event be regarded as a guarantee of conditions or characteristics. With respect to any examples or hints given herein, any typical values stated herein and/or any information regarding the application of the device, Infineon Technologies hereby disclaims any and all warranties and liabilities of any kind, including without limitation, warranties of non-infringement of intellectual property rights of any third party.

**Information**

For further information on technology, delivery terms and conditions and prices, please contact the nearest Infineon Technologies Office ([www.infineon.com/rfpower](http://www.infineon.com/rfpower)).

**Warnings**

Due to technical requirements, components may contain dangerous substances. For information on the types in question, please contact the nearest Infineon Technologies Office.

Infineon Technologies components may be used in life-support devices or systems only with the express written approval of Infineon Technologies, if a failure of such components can reasonably be expected to cause the failure of that life-support device or system or to affect the safety or effectiveness of that device or system. Life support devices or systems are intended to be implanted in the human body or to support and/or maintain and sustain and/or protect human life. If they fail, it is reasonable to assume that the health of the user or other persons may be endangered.

## Looking for pricing, stock, or lifecycle information?

Click below to explore more details on WIN SOURCE:

 [View PTFA080551F-V4-R250 on WIN SOURCE](#)

 [Cree/Wolfspeed Information](#)

## Optimize Your Supply Chain with WIN SOURCE Solutions

-  Global Sourcing Solution
-  Obsolete Management
-  Cost Control Management
-  Shortage Management
-  Alternative Solution
-  Excess Inventory Management