



THE DATASHEET OF PVA3055



Series PVA30
 Microelectronic Power IC
 BOSFET® Photovoltaic Relay
 Single-Pole, 40mA, 0-300V AC/DC

General Description

The Photovoltaic AC Relay (PVA) is a single-pole, normally open solid state replacement for electro-mechanical relays used for general purpose switching of analog signals. It utilizes as an output switch a unique bidirectional (AC or DC) MOSFET power IC termed a BOSFET. The BOSFET is controlled by a photovoltaic generator of novel construction, which is energized by radiation from a dielectrically isolated light emitting diode (LED).

The PVA30 series combines very low solid state output capacitance, very high off-state resistance and very fast response. These Photovoltaic Relays are designed specifically to accurately switch low-level signals in high-performance instrumentation systems.

The PVA overcomes the limitations of both conventional and reed electromechanical relays by offering the solid state advantages of long life, high operating speed, low pick-up power, bounce-free operation, low thermal voltages and miniaturization. These advantages allow product improvement and design innovations in many applications such as process control, multiplexing, telecommunications, automatic test equipment and data acquisition.

The PVA30 series can switch analog signals from thermocouple level to 300 volts peak AC or DC polarity. Signal frequencies into the RF range are easily controlled and switching rates up to 25kHz are achievable.

The extremely small thermally generated offset voltages allow increased measurement accuracies. The critical output semiconductors are completely shielded from the infra-red radiation of the input LED. Therefore, photocurrents in the output BOSFET are nonexistent and there is not an output offset resulting from radiation from the input LED drive.

Unique silicon technology developed by International Rectifier forms the heart of the PVA. The monolithic BOSFET contains a bidirectional N-channel power MOSFET output structure. In addition, this power IC chip has input circuitry for fast turn-off and gate protection functions. This section of the BOSFET chip utilizes both bipolar and MOS technology to form NPN transistors, P-channel MOSFETs, resistors, diodes and capacitors.

The photovoltaic generator similarly utilizes a unique International Rectifier alloyed multijunction structure. The excellent current conversion efficiency of this technique results in the very fast response of the PVA microelectronic power IC relay.

This advanced semiconductor technology has created a radically new control device. Designers can now develop switching systems to new standards of electrical performance and mechanical compactness.

Features

- BOSFET Power IC ■
- 10¹⁰ Operations ■
- 25µsec Operating Time ■
- Low Output Capacitance ■
- 0.2µVolt Thermal Offset ■
- Offset Independent of Input Drive ■
- 3 milliwatts Pick-Up Power ■
- 1000V/µsec dv/dt ■
- Bounce-Free ■
- 8-pin DIP Package ■
- 40°C to 85°C ■
- UL recognized ■

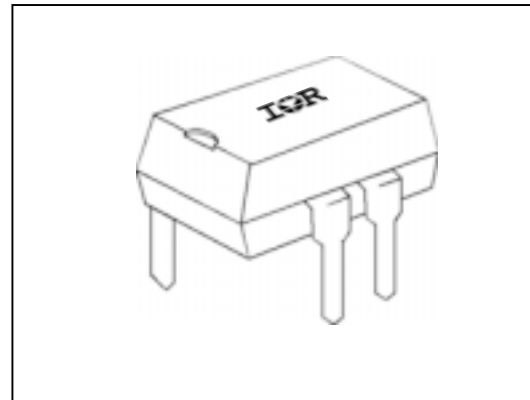

Part Identification

Part Number	Operating Voltage (AC/DC)	Sensitivity	Off-State Resistance
PVA3054	0 – 300V	5 mA	10 ¹⁰ Ohms
PVA3055			10 ¹¹ Ohms

(BOSFET is a trademark of International Rectifier)

Electrical Specifications ($-40^{\circ}\text{C} \leq T_A \leq +85^{\circ}\text{C}$ unless otherwise specified)

INPUT CHARACTERISTICS	PVA3054	PVA3055	Units
Minimum Control Current (see figure 1) For 40mA Continuous Load Current For 22mA Continuous Load Current	5.0 5.0		DC mA@40°C mA@60°C
Maximum Control Current for Off-State Resistance at 25°C	10		μA(DC)
Control Current Range (Caution: current limit input LED. See figure 6)	2.0 to 25		mA(DC)
Maximum Reverse Voltage	7.0		V(DC)

OUTPUT CHARACTERISTICS	PVA3054	PVA3055	Units
Operating Voltage Range	0 to ± 300		V _(PEAK)
Maximum Load Current 40°C (see figure 1)	40		mA(DC)
Response Time @25°C (see figures 7 and 8) Maximum T _(on) @ 12mA Control, 20 mA Load, 100 VDC	25		μs
Maximum T _(off) @ 12mA Control, 20 mA Load, 100 VDC	15		μs
Max. On-state Resistance 25°C (Pulsed) (fig. 4) 10 mA Load, 5mA Control	160		Ω
Minimum Off-state Resistance 25°C @ 240 VDC	10 ¹⁰	10 ¹¹	Ω
Maximum Off-state Leakage 25°C @ 5.0 VDC (see figure 5)	—	0.05	nA
Maximum Thermal Offset Voltage @ 5.0mA Control V _{O(ISO)}	0.2		μvolts
Minimum Off-State dv/dt	1000		V/μs
Maximum Output Capacitance (see figure 9)	3.0		pF @ 40VDC

GENERAL CHARACTERISTICS (PVA3054 and PVA3055)		Units	
Dielectric Strength: Input-Output		2500	V _{RMS}
Insulation Resistance: Input-Output @ 90V _{DC}		10 ¹² @ 25°C - 50% RH	Ω
Maximum Capacitance: Input-Output		1.0	pF
Max. Pin Soldering Temperature (1.6mm below seating plane, 10 seconds max.)		+260	°C
Ambient Temperature Range: Operating		-40 to +85	
Storage		-40 to +100	

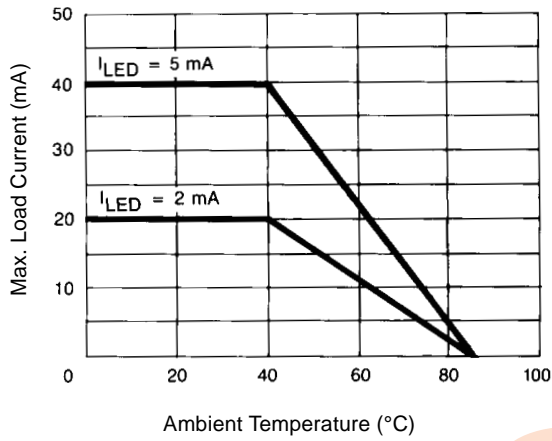

Figure 1. Current Derating Curves

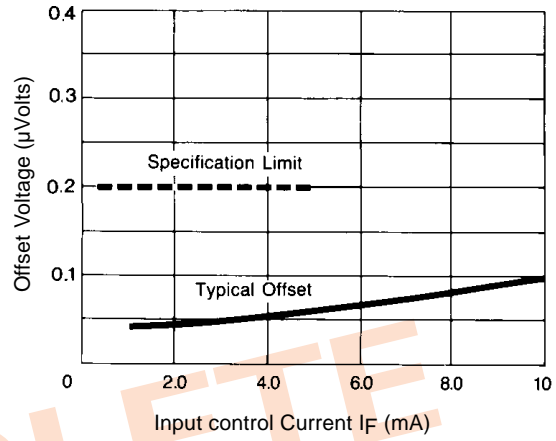

Figure 2. Offset Voltage

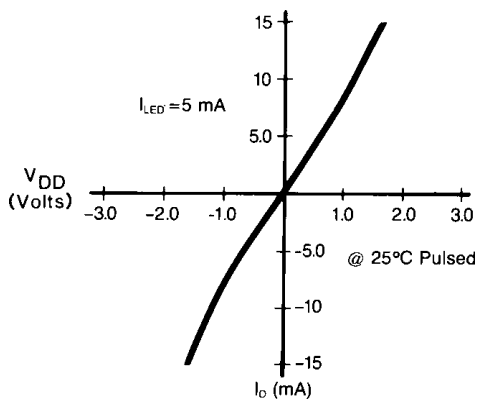

Figure 3. Typical On Characteristics

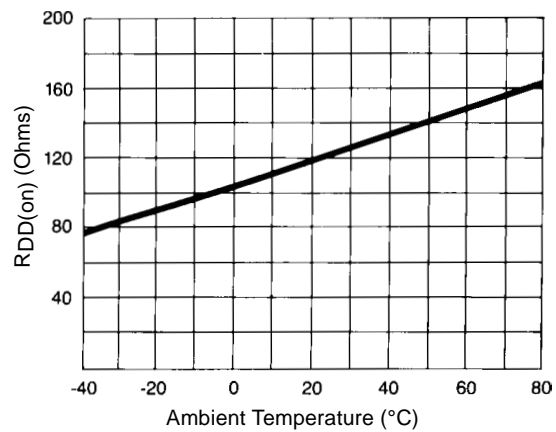

Figure 4. Typical On-Resistance

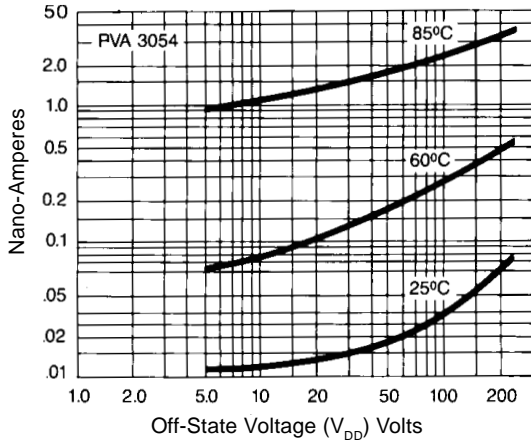

Figure 5. Typical Variation of Off-State Leakage Current

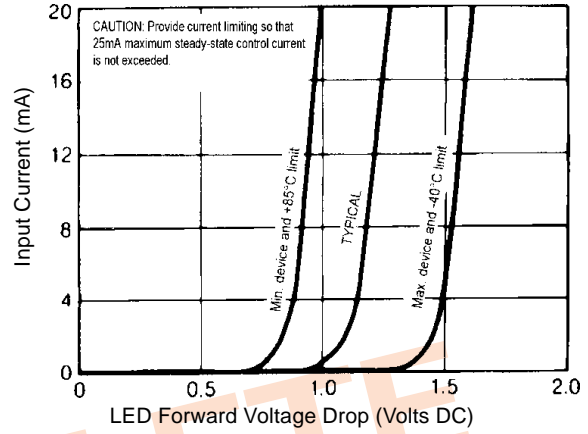

Figure 6. Input Characteristics (Current Controlled)

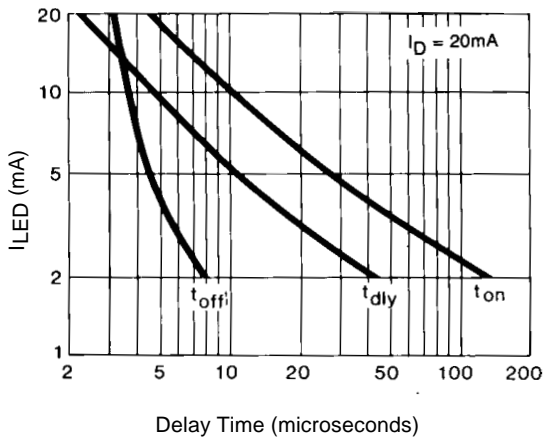

Figure 7. Typical Delay Times

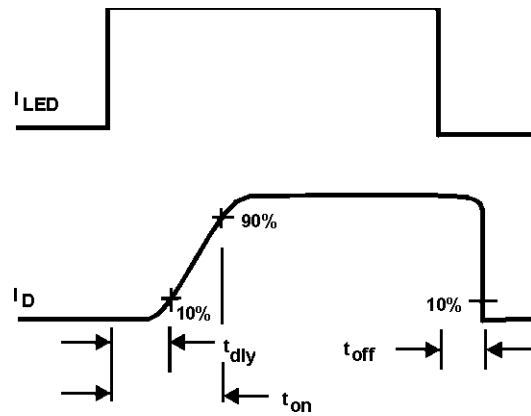

Figure 8. Delay Time Definitions

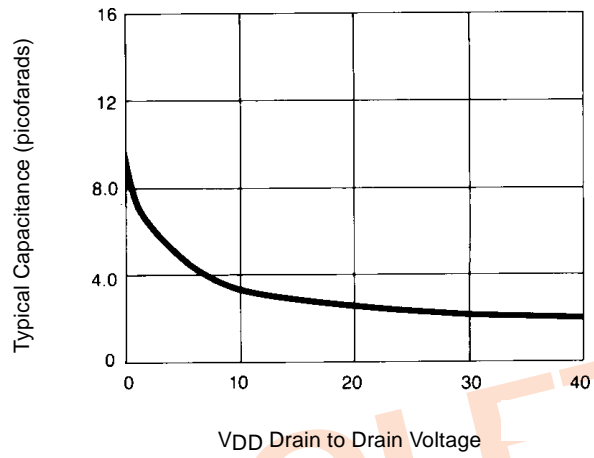
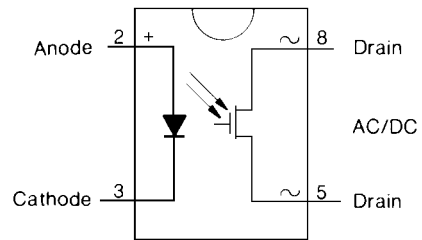

Figure 9. Typical Output Capacitance

OBSOLETE

Wiring Diagram



Case Outline

(Dimensions in millimeters (inches))

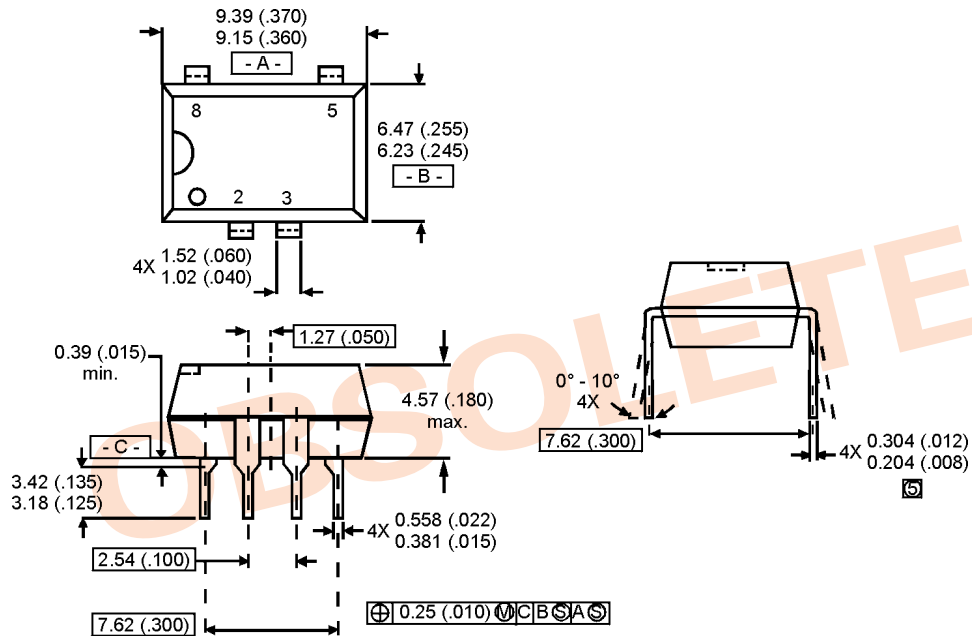



Mechanical Specifications:

- Package: 8-pin DIP
- Tolerances: .015 (.38) unless otherwise specified
- Case Material: molded epoxy
- Weight: .07 oz. (2 gr.)

Looking for pricing, stock, or lifecycle information?

Click below to explore more details on WIN SOURCE:

-  [View PVA3055 on WIN SOURCE](#)
-  [Infineon Technologies](#) Information

Optimize Your Supply Chain with WIN SOURCE Solutions

-  Global Sourcing Solution
-  Obsolete Management
-  Cost Control Management
-  Shortage Management
-  Alternative Solution
-  Excess Inventory Management