



**THE DATASHEET OF
RCD-24-0.70/PL/A**



Features

Regulated Converters

- SMD Constant Current LED Driver
- Built-in Class A or Class B EMC Filter
- Wide Input and Output Voltage Range
- Digital PWM and Analogue Voltage Dimming
- Short Circuit and Overtemperature Protected
- Low Cost
- EN/RAILWAYS Certified
- 5 Year Warranty

Description

The RCD-24-xxx/PL series is a step-down constant current source designed for driving high power LEDs. The converter uses a pinless SMD open frame design to reduce cost and size. Output currents available are 300mA, 350mA, 500mA, 600mA, 700mA and 1000mA with either Class A (Suffix /A) or Class B (suffix /B) built-in EMC filtering. Despite its compact size, the RCD-PL series is fully featured with very high efficiency, wide input voltage range, high ambient operating temperature and two means of LED dimming: PWM/digital control and analogue voltage dimming. Both dimming controls are independent and can be combined. The driver is also designed to be as reliable as the LEDs it is driving, even at the full ambient operating temperature and is designed for strip lighting, wall washers and fluorescent tube replacement designs, where a low profile and narrow width are demanded.

Selection Guide

| Part Number | Input Range (VDC) | Output Current (mA) | Output Voltage (Vmin-Vmax) | Dimming Control | Mounting Style |
|------------------|-------------------|---------------------|----------------------------|--------------------|----------------|
| RCD-24-0.30/PL* | 4.5-36V | 0-300 | 2-35 | Digital + Analogue | Pinless SMD |
| RCD-24-0.35/PL* | 4.5-36V | 0-350 | 2-35 | Digital + Analogue | Pinless SMD |
| RCD-24-0.50/PL* | 4.5-36V | 0-500 | 2-35 | Digital + Analogue | Pinless SMD |
| RCD-24-0.60/PL* | 4.5-36V | 0-600 | 2-35 | Digital + Analogue | Pinless SMD |
| RCD-24-0.70/PL* | 4.5-36V | 0-700 | 2-35 | Digital + Analogue | Pinless SMD |
| RCD-24-1.00/PL/A | 6-36V | 0-1000 | 2-32 | Digital + Analogue | Pinless SMD |

* /A for EMC Class A input Filter add -R for Tape and Reel Packaging e.g. RCD-24-0.35/PL/B-R

* /B for EMC Class B input Filter

Note: RCD-24-1.00/PL/A only available with Class A Filter

Specifications (typical at 25°C, nominal input voltage, rated output current unless otherwise specified)

| | | |
|------------------------------------|--|--|
| Input Voltage (absolute maximum) | 40VDC max | |
| Recommended Input Voltage | 6V min. / 24V typ. / 36VDC max | |
| Input Filter | Suffix /A Suffix /B RCD-24-1.00/PL/A | Capacitor Class B with Pi Filter Class A with Pi Filter |
| Output Current Accuracy (Vin=24V) | 300-700mA 1000mA | ±2% typ, ±3% max ±3% typ, ±5% max |
| Internal Power Dissipation | Worst case load of 5 LEDs (300-700mA) Worst case load of 8 LEDs (1000mA), Vin=36V | 700mW max. 1.6W typ. |
| Output Current Stability | Vin = 36V, Vout = 1-9 LEDs (300-700mA) Vin = 36V, Vout = 1-8 LEDs (1000mA) | ±1% max ± 1.5% max. |
| Output Ripple and Noise (20MHz BW) | Vin=36V, Vout = 1-9 LEDs (300-700mA) Vin=36V, Vout = 1-8 LEDs (1000mA) | 300mVp-p max |
| Temperature Coefficient | -40°C to +85°C ambient ±0.015%/°C max | |
| Maximum Capacitive Load | 100µF | |
| Operating Frequency | 300-1000mA | 212kHz min/ 250kHz typ/ 280kHz max |
| Efficiency at Full Load | 300-700mA Vin=36V, Vout=8 LEDs (1000mA) | 96% typ. 94% typ. |
| Short Circuit Protection | Regulated at rated output current | |
| Operating Temperature Range | 300/350mA 500mA 600/700mA 1000mA | -40°C to +85°C -40°C to +80°C -40°C to +75°C -40°C to +65°C |
| Storage Temperature Range | -55°C to +125°C | |
| Relative Humidity | 5% to 95% RH, non-condensing | |

continued on next page

LIGHTLINE

DC/DC-Converter

with 5 year Warranty

RECOM

Constant Current LED Driver



E358085

EN-50121-3-2 Certified

EN-60950-1 Certified

UL-60950-1 Certified

RCD-24/PL

Derating-Graph

(Ambient Temperature)

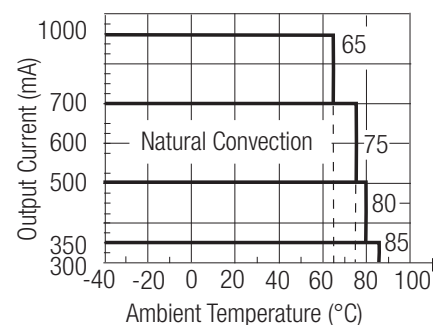

Refer to Application Notes

Specifications (typical at 25°C, nominal input voltage, rated output current unless otherwise specified)

| | | |
|--|------------------------------------|---------------------------|
| Dimensions | 31.0 x 11.4 x 6.6mm | |
| Weight | 1.9g | |
| Packing Quantity | 12 pcs per Tube / 400 pcs per Reel | |
| Reflow Soldering Profile | 265°C/10 sec max | |
| MTBF | (using MIL HDBK 217F) +25°C | >600 khours |
| PWM Dimming and ON/OFF Control (Leave open if not used) | | |
| Remote ON/OFF | DC/DC ON | Open or $0V < V_r < 0.6V$ |
| Threshold Voltages | DC/DC OFF (Standby) | $0.6 < V_r < 2.9V$ |
| | DC/DC OFF (Full Shutdown) | $2.9V < V_r < 6V$ |
| Remote Pin Drive Current | $V_r = 5V$ | 1mA max |
| Quiescent Input Current in Shutdown Mode | $V_{in} = 36V$ | 200µA max |
| Recommended PWM Frequency (measured 10%~90% Dimming) | For Linear Operation | 200Hz |
| | Maximum Frequency | 1000Hz |
| Analogue Dimming Control (leave open if not used) | | |
| Input Voltage Range | 300-1000mA | -0.3V - 15V |
| Control Voltage Range Limits (see Graph) | 300-1000mA / Full On | $0.13V \pm 50mV$ |
| | 300-700mA / Full Off | $4.2V \pm 150mV$ |
| | 1000mA / Full Off | $4.35V \pm 100mV$ |
| Analogue Pin Drive Current | 300-1000mA / $V_c = 5V$ | 0.2mA max. |
| Environmental | | |
| Shock / Vibration | | EN61373 |
| EMC Railways | | EN50121-3-2:2006 |
| Conducted Emissions | 300-1000mA (/A Suffix) | EN55022, Class A |
| | 300-700mA (/B Suffix) | EN55022, Class B |
| Radiated Emissions | | EN55022, Class B |
| ESD | | EN61000-4-2, Criterion A |
| Radiated Immunity | | EN61000-4-3, Criterion A |
| Fast Transient | | EN61000-4-4, Criterion A |
| Conducted Immunity | | EN61000-4-6, Criterion A |

Note:

- All LED Drivers may not be used without a load. They must be switched on the primary side only. Noncompliance may damage the LED or reduce its lifetime.
- It is not possible to parallel the drivers to increase the current.

Typical Characteristics

$V_{in} = 24V, I_{out} = 300 \sim 1000mA$

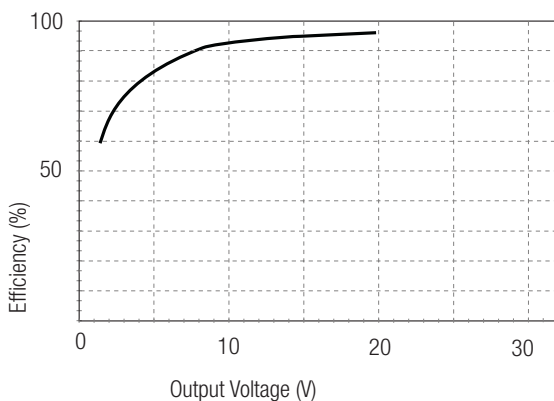

$V_{in} = 32V, I_{out} = 300 \sim 1000mA$

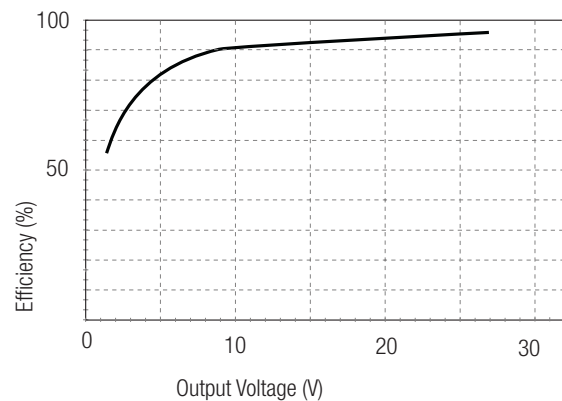

Dimming

Digital Dimming

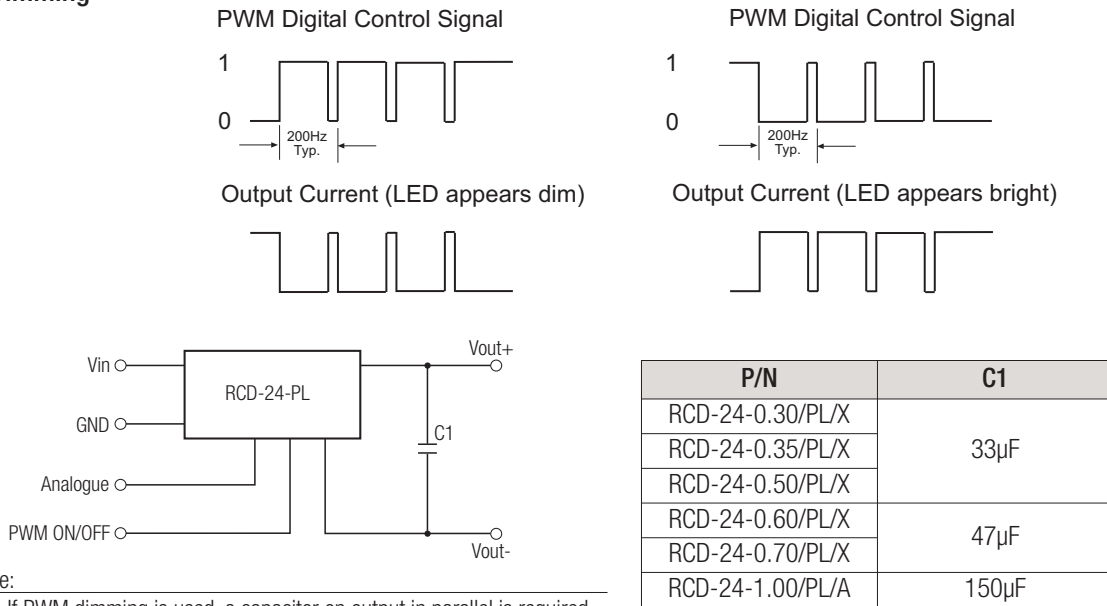

Note:

3. If PWM dimming is used, a capacitor on output in parallel is required.

Analogue Dimming

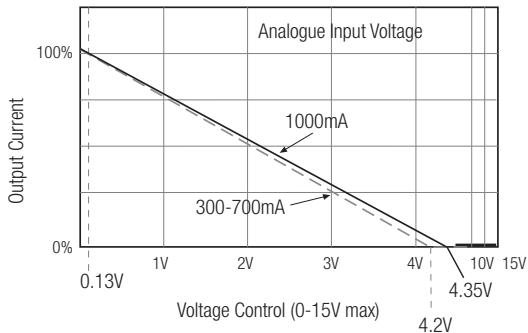

Package Style and Pinning

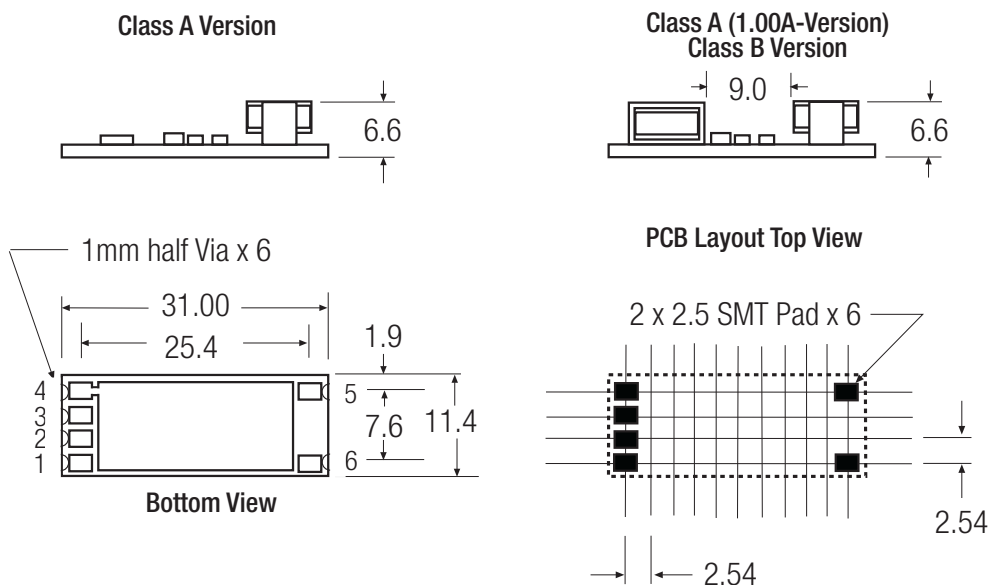



| Pad Connections | | RCD-24-PL Series |
|-----------------|------------------|-------------------------|
| Pad # | Out | Comments |
| 1 | +Vin | DC Supply |
| 2 | Analogue Dimming | Leave open if not used |
| 3 | PWM/ON/OFF | Leave open if not used |
| 4 | GND | Do not connect to -Vout |
| 5 | -Vout | LED Cathode Connection |
| 6 | +Vout | LED Anode Connection |

XX.X ± 0.5 mm
XX.XX ± 0.25 mm

The product information and specifications are subject to change without prior notice. RECOM products are not authorized for use in safety-critical applications (such as life support) without RECOM's explicit written consent. A safety-critical application is defined as an application where a failure of a RECOM product may reasonably be expected to endanger or cause loss of life, inflict bodily harm or damage property. The buyer shall indemnify and hold harmless RECOM, its affiliated companies and its representatives against any damage claims in connection with the unauthorized use of RECOM products in such safety-critical applications.

Looking for pricing, stock, or lifecycle information?

Click below to explore more details on WIN SOURCE:

-  [View RCD-24-0.70/PL/A on WIN SOURCE](#)
-  [Recom Power Information](#)

Optimize Your Supply Chain with WIN SOURCE Solutions

-  Global Sourcing Solution
-  Obsolete Management
-  Cost Control Management
-  Shortage Management
-  Alternative Solution
-  Excess Inventory Management