



THE DATASHEET OF RT9055-VMWSC



300mA Dual LDO Regulator

General Description

The RT9055 is a dual channel, low noise, and low dropout regulator sourcing up to 300mA at each channel. The output voltage range is from 0.9V to 3.5V with an input voltage range from 1.5V to 5.5V.

The RT9055 offers 2% accuracy, extremely low dropout voltage and extremely low quiescent current (only 29µA per LDO). The shutdown current is near zero which is suitable for battery powered applications. The RT9055 also provides protection functions such as current limiting, output short circuit protection, and over temperature protection.

The RT9055 allows stable operation with very small ceramic output capacitors, hence minimizing required board space and component cost.

The RT9055 is available in a WL-CSP-6B 0.8x1.2 package.

Ordering Information

RT9055-□□□

- Package Type
WSC : WL-CSP-6B 0.8x1.2
- Output Voltage : VOUT1/VOUT2
VOUT2 > VOUT1 is Recommended

Note :

Richtek products are :

- ▶ RoHS compliant and compatible with the current requirements of IPC/JEDEC J-STD-020.
- ▶ Suitable for use in SnPb or Pb-free soldering processes.

Marking Information

For marking information, contact our sales representative directly or through a Richtek distributor located in your area.

Features

- Wide Operating Voltage Range : 1.5V to 5.5V
- Low Noise for RF Application
- No Noise Bypass Capacitor Required
- Fast Response in Line/Load Transient
- TTL Logic Controlled Shutdown Input
- Low Temperature Coefficient
- Dual LDO Outputs (300mA/300mA)
- Ultra-Low Quiescent Current : 29µA/LDO
- High Output Accuracy 2%
- Short Current Protection
- Thermal Shutdown Protection
- Current Limit Protection
- Short Circuit Thermal Folded Back Protection
- RoHS Compliant and Halogen Free

Applications

- Cellular Handsets
- Battery Powered Equipment
- Hand-Held Instruments
- Portable Information Appliances

Pin Configurations

(TOP VIEW)

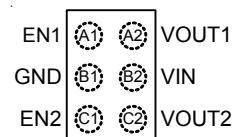

WSC-CSP-6B 0.8x1.2

Available Voltage Version

Code	Voltage	Code	Voltage	Code	Voltage
A	3.5	B	1.3	C	1.2
D	1.85	E	2.1	F	1.5
G	1.8	H	2	J	2.5
K	2.6	L	2.7	M	2.8
N	2.85	P	3	Q	3.1
R	3.2	S	3.3	T	2.65
V	2.9	W	1.6	X	3.15
Y	1.9	U	1.4	Z	1.25
2	1.1	3	1		

Typical Application Circuit

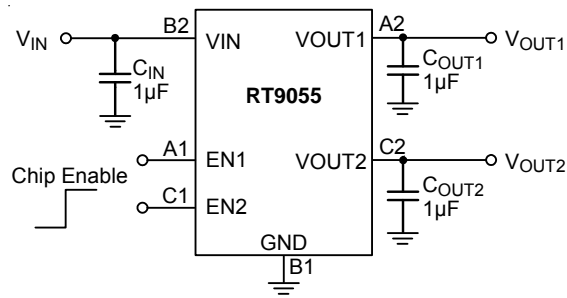

Functional Pin Description

Pin No.	Pin Name	Pin Function
A1	EN1	LDO1 Enable (Active High).
A2	VOUT1	LDO1 Output Voltage.
B1	GND	Ground.
B2	VIN	Supply Input.
C1	EN2	LDO2 Enable (Active High).
C2	VOUT2	LDO2 Output Voltage.

Function Block Diagram

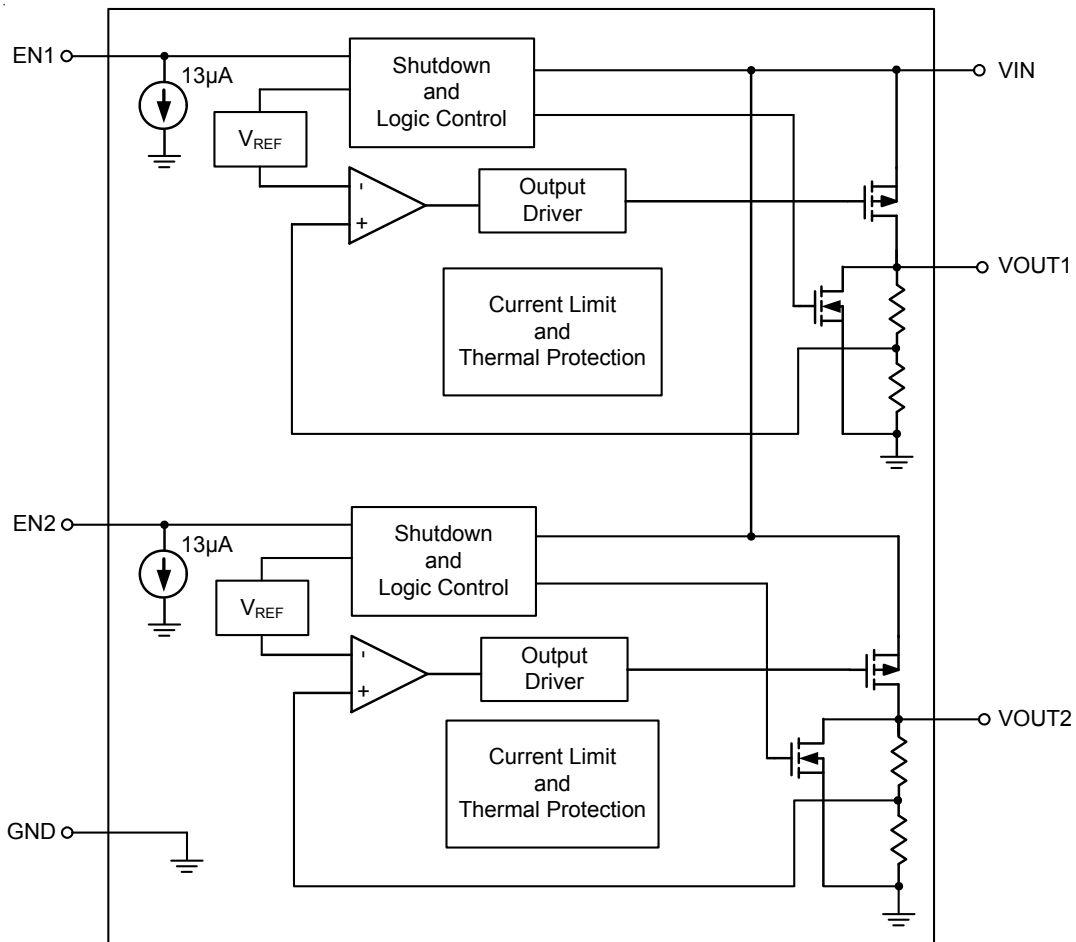

Absolute Maximum Ratings (Note 1)

- Supply Input Voltage, V_{IN} ----- -0.3V to 6V
- Other I/O Pins Voltages ----- -0.3V to 6V
- Power Dissipation, $P_D @ T_A = 25^\circ\text{C}$
 WL-CSP-6B 0.8x1.2 ----- 0.670W
- Package Thermal Resistance (Note 2)
 WL-CSP-6B 0.8x1.2, θ_{JA} ----- 148°C/W
- Lead Temperature (Soldering, 10 sec.) ----- 260°C
- Junction Temperature ----- 150°C
- Storage Temperature Range ----- -65°C to 150°C
- ESD Susceptibility (Note 3)
 HBM (Human Body Model) ----- 2kV
 MM (Machine Model) ----- 200V

Recommended Operating Conditions (Note 4)

- Supply Input Voltage, V_{IN} ----- 1.5V to 5.5V
- Junction Temperature Range ----- -40°C to 125°C
- Ambient Temperature Range ----- -40°C to 85°C

Electrical Characteristics

($V_{IN} = V_{OUT} + 1V$, $C_{IN} = C_{OUT} = 1\mu\text{F}$, $T_A = -40^\circ\text{C}$ to 85°C , unless otherwise specified)

Parameter	Symbol	Test Conditions	Min	Typ	Max	Unit	
Input Power Supply							
Dropout Voltage (Note 5)	V_{DROP}	$V_{OUT} = 1.2V$ to $1.4V$, $I_{OUT} = 300mA$	50	--	550	mV	
		$V_{OUT} = 1.5V$ to $2.4V$, $I_{OUT} = 300mA$	40	--	400		
		$V_{OUT} = 2.5V$ to $3.5V$, $I_{OUT} = 300mA$	20	--	300		
Output Voltage Range	V_{OUT}		0.9	--	3.5	V	
V_{OUT} Accuracy	ΔV	$I_{OUT} = 1mA$ to $300mA$	-2	--	2	%	
Line Regulation	ΔV_{LINE}	$V_{IN} = (V_{OUT} + 1)$ to $5.5V$, $I_{OUT} = 1mA$	-2	--	2	%	
Load Regulation	ΔV_{LOAD}	$1mA < I_{OUT} < 300mA$	-1.5	--	1.5	%	
Current Limit	I_{LIM}	$R_{LOAD} = 0\Omega$	350	600	--	mA	
Quiescent Current	I_Q	$V_{EN} > 1.5V$	--	58	--	μA	
Shutdown Current	I_{SHDN}	$V_{EN} < 0.4V$	--	--	1	μA	
EN Input Threshold Voltage	Logic-High	V_{IH}	$V_{IN} = 2.5V$ to $5.5V$, Power On	1.2	--	--	V
	Logic-Low	V_{IL}	$V_{IN} = 2.5V$ to $5.5V$, Shutdown	--	--	0.4	
V_{OUT} Discharge Resistance in Shutdown (Note 6)		$V_{IN} = 5V$, $EN1 = EN2 = GND$	--	3	--	$k\Omega$	
EN Pull Low Current	I_{EN}		8	13	18	μA	
Thermal Shutdown	T_{SD}		--	170	--	$^\circ\text{C}$	
Thermal Shutdown Hysteresis	ΔT_{SD}		--	40	--	$^\circ\text{C}$	

Parameter	Symbol	Test Conditions	Min	Typ	Max	Unit
Power Supply Rejection Ratio	PSRR	f = 100Hz, $V_{IN} = V_{OUT} + 1V$, $C_{OUT} = 2.2\mu F$, $I_{LOAD} = 50mA$	--	70	--	dB
		f = 1kHz, $V_{IN} = V_{OUT} + 1V$, $C_{OUT} = 2.2\mu F$, $I_{LOAD} = 50mA$	--	70	--	
		f = 10kHz, $V_{IN} = V_{OUT} + 1V$, $C_{OUT} = 2.2\mu F$, $I_{LOAD} = 50mA$	--	70	--	
		f = 100kHz, $V_{IN} = V_{OUT} + 1V$, $C_{OUT} = 2.2\mu F$, $I_{LOAD} = 50mA$	--	54	--	
		f = 200kHz, $V_{IN} = V_{OUT} + 1V$, $C_{OUT} = 2.2\mu F$, $I_{LOAD} = 50mA$	--	45	--	
		f = 300kHz, $V_{IN} = V_{OUT} + 1V$, $C_{OUT} = 2.2\mu F$, $I_{LOAD} = 50mA$	--	38	--	
Output Voltage Noise		$C_{OUT1} = C_{OUT2} = 10\mu F$, 10Hz to 100kHz, $I_{OUT1} = I_{OUT2} = 1mA$	--	100	--	μV_{RMS}

Note 1. Stresses beyond those listed “Absolute Maximum Ratings” may cause permanent damage to the device. These are stress ratings only, and functional operation of the device at these or any other conditions beyond those indicated in the operational sections of the specifications is not implied. Exposure to absolute maximum rating conditions may affect device reliability.

Note 2. θ_{JA} is measured at $T_A = 25^\circ C$ on a high effective thermal conductivity four-layer test board per JEDEC 51-7. The CSP balls connect directly to the internal GND copper plane by 2 vias, the via diameter is about 1mm.

Note 3. Devices are ESD sensitive. Handling precaution is recommended.

Note 4. The device is not guaranteed to function outside its operating conditions.

Note 5. The dropout voltage is defined as $V_{IN} - V_{OUT}$, which is measured when V_{OUT} is $V_{OUT(NORMAL)} - 100mV$.

Note 6. It is guaranteed by design.

Typical Operating Characteristics

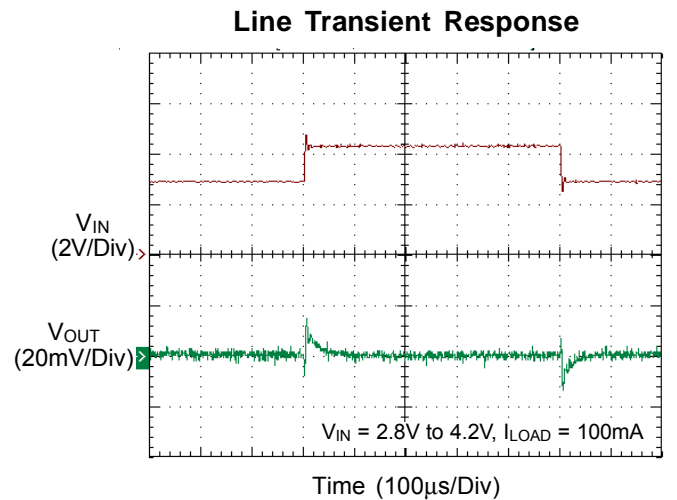
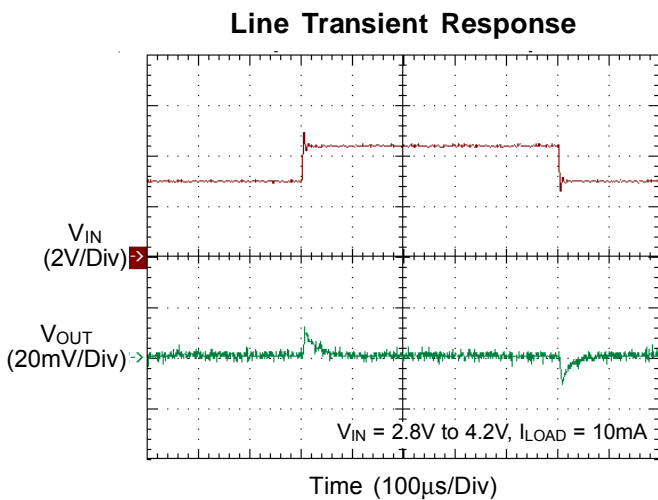
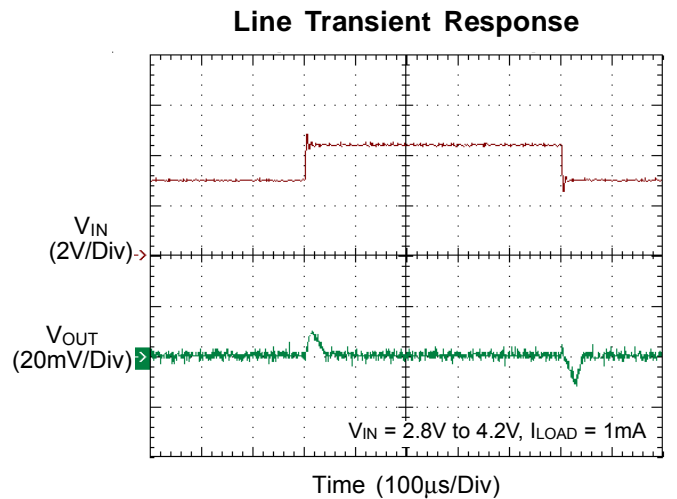
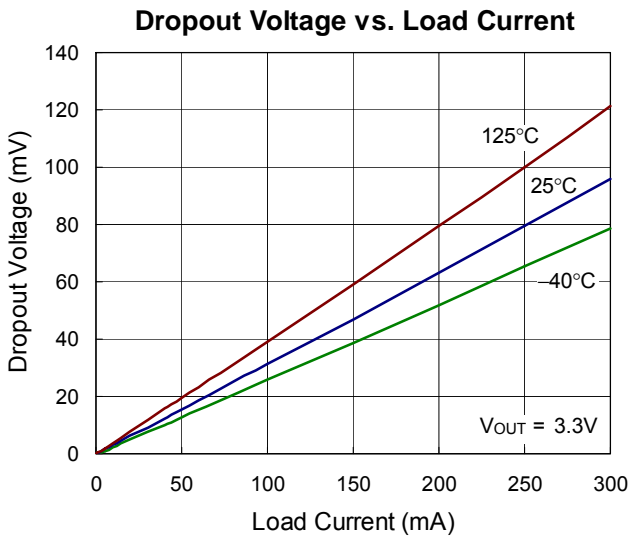
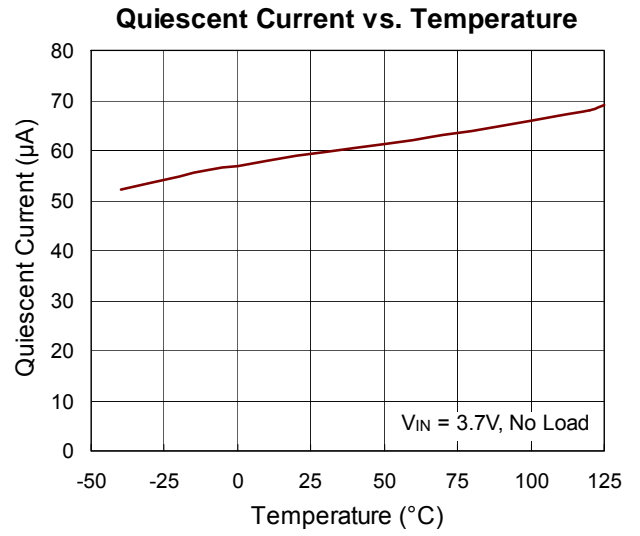
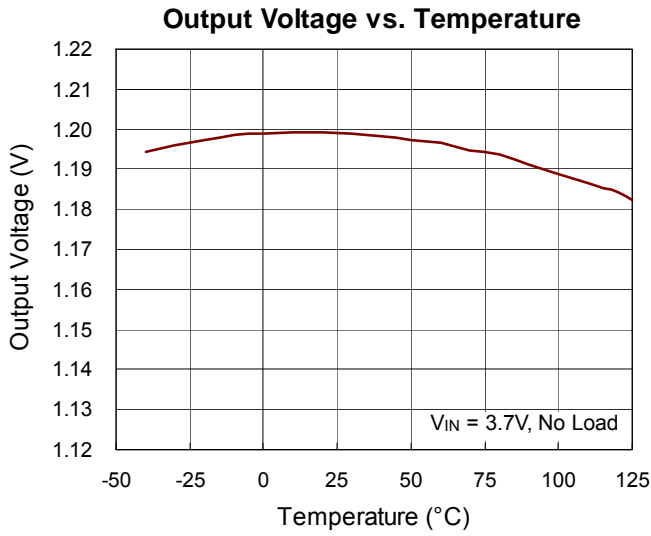

Line Transient Response

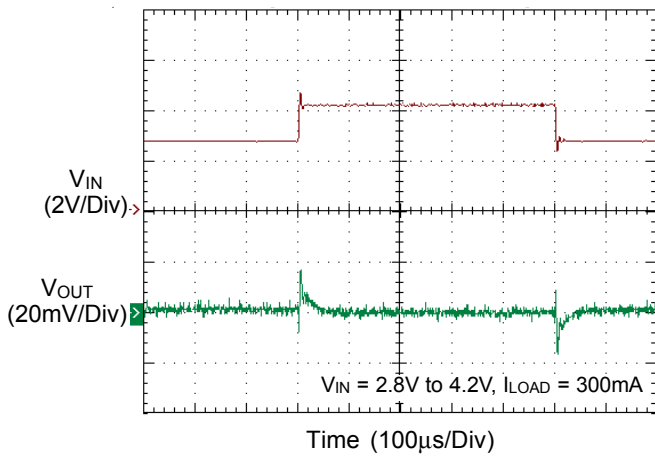

Load Transient Response

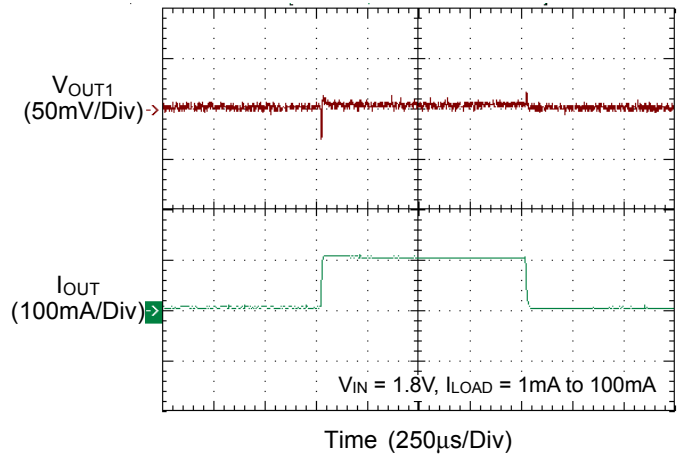

Load Transient Response

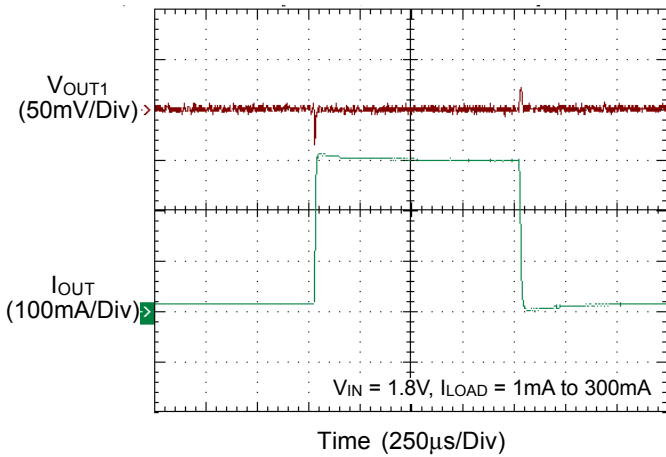

Power On from EN

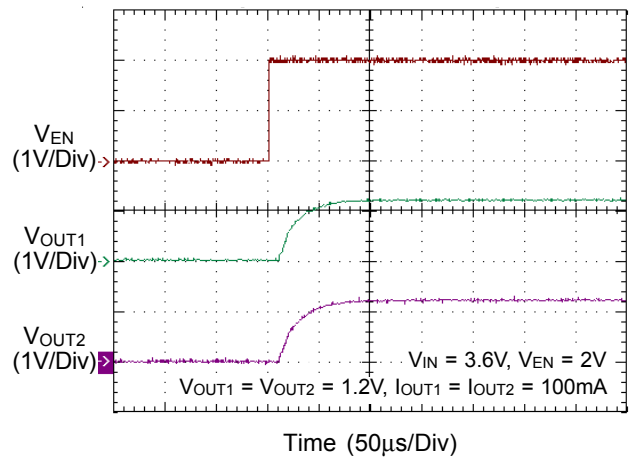

Power Off from EN

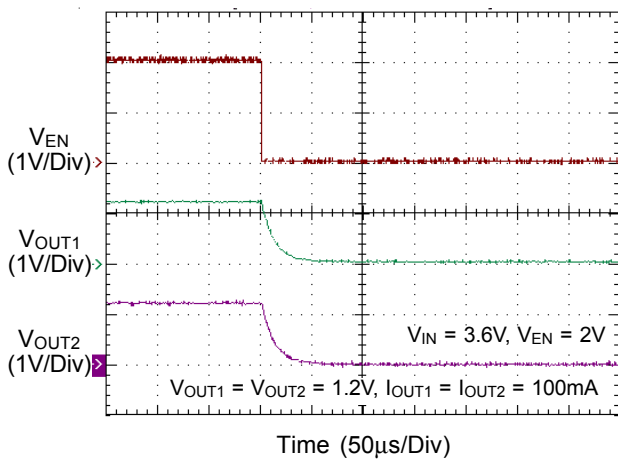

VOUT1 Noise

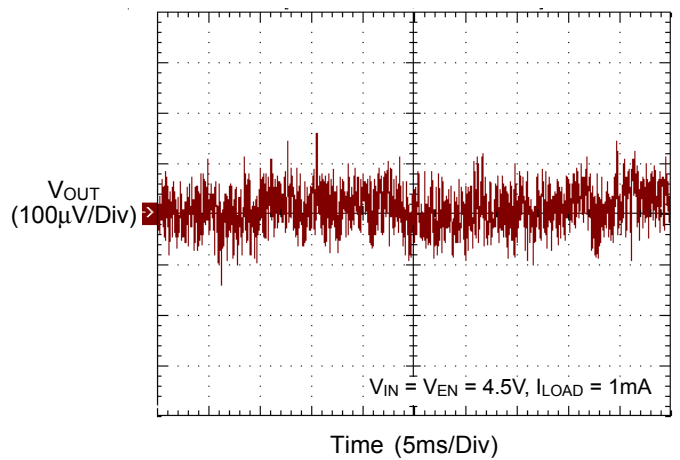

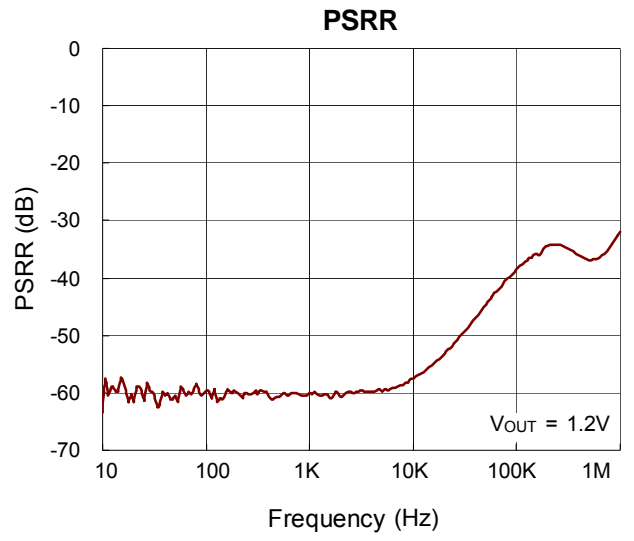
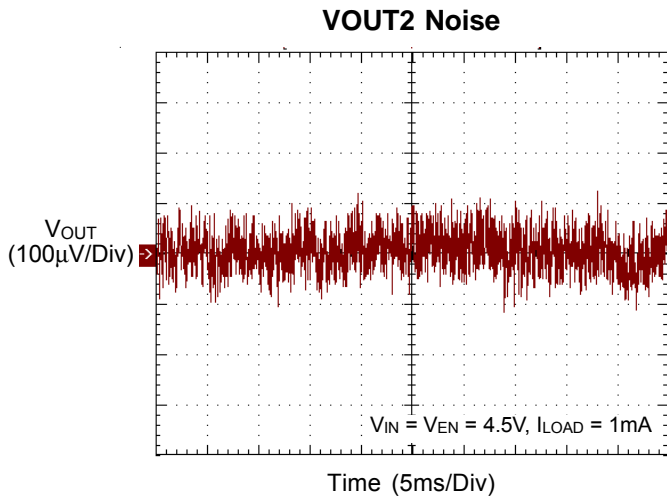

Applications Information

Like any low-dropout regulator, the external capacitors used with the RT9055 must be carefully selected for regulator stability and performance. Using a capacitor whose value is >1μF on the RT9055 input and the amount of capacitance can be increased without limit. The input capacitor must be located a distance of not more than 0.5 inch from the input pin of the IC and returned to a clean analog ground. Any good quality ceramic or tantalum can be used for this capacitor. The capacitor with larger value and lower ESR (equivalent series resistance) provides better PSRR and line-transient response.

The output capacitor must meet both requirements for minimum amount of capacitance and ESR in all LDOs application. The RT9055 is designed specifically to work with low ESR ceramic output capacitor in space-saving and performance consideration. Using a ceramic capacitor whose value is at least 1μF with ESR is > 20mΩ on the RT9055 output ensures stability. The RT9055 still works well with output capacitor of other types due to the wide stable ESR range. Figure 1 shows the curves of allowable ESR range as a function of load current for various output capacitor values. Output capacitor of larger capacitance can reduce noise and improve load transient response, stability, and PSRR. The output capacitor should be located not more than 0.5 inch from the VOUT pin of the RT9055 and returned to a clean analog ground.

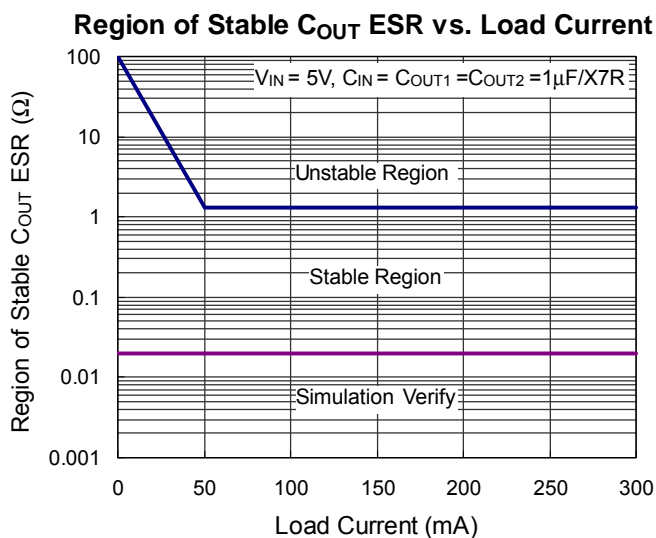

Figure 1. Stable C_{OUT} ESR Range

Thermal Considerations

For continuous operation, do not exceed absolute maximum junction temperature. The maximum power dissipation depends on the thermal resistance of the IC package, PCB layout, rate of surrounding airflow, and difference between junction and ambient temperature. The maximum power dissipation can be calculated by the following formula :

$$P_{D(MAX)} = (T_{J(MAX)} - T_A) / \theta_{JA}$$

where T_{J(MAX)} is the maximum junction temperature, T_A is the ambient temperature, and θ_{JA} is the junction to ambient thermal resistance.

For recommended operating condition specifications, the maximum junction temperature is 125°C. For WL-CSP-6B 0.8x1.2 package, the thermal resistance, θ_{JA}, is 148°C/W on a standard JEDEC 51-7 four-layer thermal test board. The maximum power dissipation at T_A = 25°C can be calculated by the following formula :

$$P_{D(MAX)} = (125^{\circ}\text{C} - 25^{\circ}\text{C}) / (148^{\circ}\text{C}/\text{W}) = 0.670\text{W}$$

for WL-CSP-6B 0.8x1.2 package

The maximum power dissipation depends on the operating ambient temperature for fixed T_{J (MAX)} and thermal resistance, θ_{JA}. The derating curves in Figure 2 allow the designer to see the effect of rising ambient temperature on the maximum power dissipation.

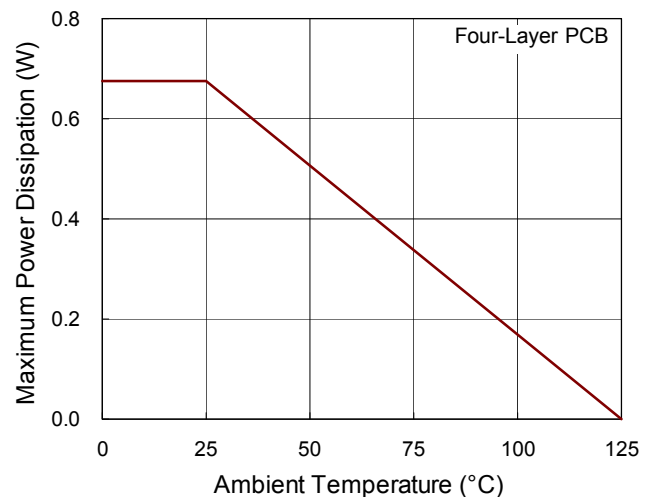
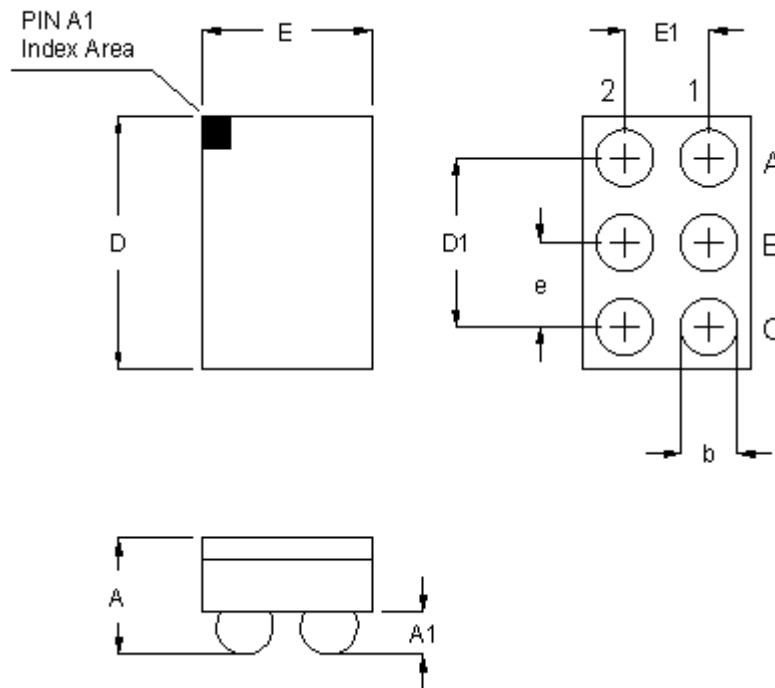

Figure 2. Derating Curve of Maximum Power Dissipation

Outline Dimension



Symbol	Dimensions In Millimeters		Dimensions In Inches	
	Min.	Max.	Min.	Max.
A	0.500	0.600	0.020	0.024
A1	0.170	0.230	0.007	0.009
b	0.240	0.300	0.009	0.012
D	1.150	1.250	0.045	0.049
D1	0.800		0.031	
E	0.750	0.850	0.030	0.033
E1	0.400		0.016	
e	0.400		0.016	

6B WL-CSP 0.8x1.2 Package (BSC)



Richtek Technology Corporation

14F, No. 8, Tai Yuen 1st Street, Chupei City
 Hsinchu, Taiwan, R.O.C.
 Tel: (8863)5526789

Richtek products are sold by description only. Richtek reserves the right to change the circuitry and/or specifications without notice at any time. Customers should obtain the latest relevant information and data sheets before placing orders and should verify that such information is current and complete. Richtek cannot assume responsibility for use of any circuitry other than circuitry entirely embodied in a Richtek product. Information furnished by Richtek is believed to be accurate and reliable. However, no responsibility is assumed by Richtek or its subsidiaries for its use; nor for any infringements of patents or other rights of third parties which may result from its use. No license is granted by implication or otherwise under any patent or patent rights of Richtek or its subsidiaries.

Looking for pricing, stock, or lifecycle information?

Click below to explore more details on WIN SOURCE:

-  [View RT9055-VMWSC on WIN SOURCE](#)
-  [Richtek USA Inc. Information](#)

Optimize Your Supply Chain with WIN SOURCE Solutions

-  Global Sourcing Solution
-  Obsolete Management
-  Cost Control Management
-  Shortage Management
-  Alternative Solution
-  Excess Inventory Management