



**THE DATASHEET OF
RT9169H-28GB**



100mA, 4 μ A Quiescent Current CMOS LDO Regulator

General Description

The RT9169/H series are 100mA ultra-low quiescent current CMOS low dropout (LDO) regulator designed for battery-powered equipments. The output voltages range from 1.2V to 5V with 0.1V per step.

The other features include 4 μ A ultra-low quiescent, low dropout voltage, high output accuracy, current limiting protection, and high ripple rejection ratio.

Ordering Information

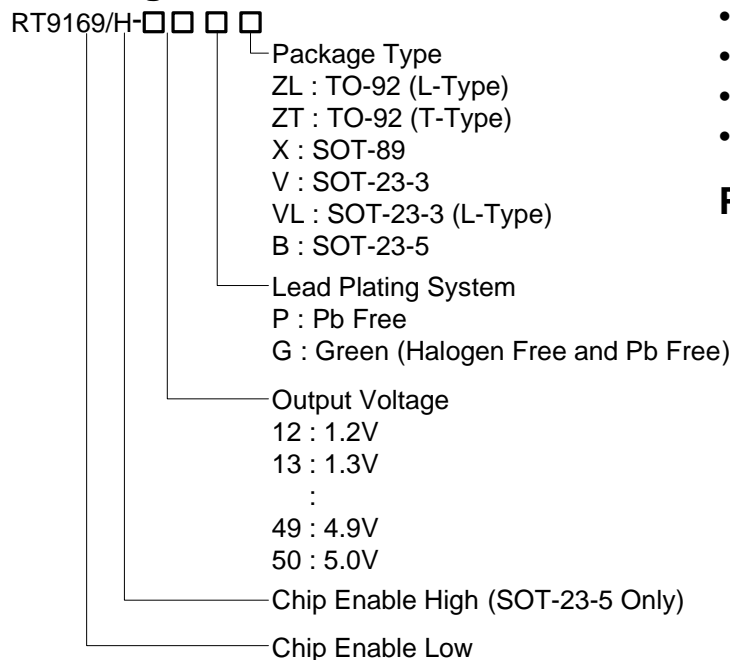

Note :

1. RT9169H package type is available in SOT-23-5 only.
2. Richtek products are :
 - ▶ RoHS compliant and compatible with the current requirements of IPC/JEDEC J-STD-020.
 - ▶ Suitable for use in SnPb or Pb-free soldering processes.

Marking Information

For marking information, contact our sales representative directly or through a Richtek distributor located in your area.

Features

- Ultra-Low Quiescent Current: 4 μ A
- Low Dropout: 450mV at 100mA
- Wide Operating Voltage Ranges: 2V to 6V
- Current Limiting Protection
- Only 1 μ F Output Capacitor Required for Stability
- High Power Supply Rejection Ratio
- RoHS Compliant and 100% Lead (Pb)-Free

Applications

- Battery-Powered Equipment
- Palmtops, Notebook Computers
- Hand-held Instruments
- PCMCIA Cards

Pin Configurations

(TOP VIEW)

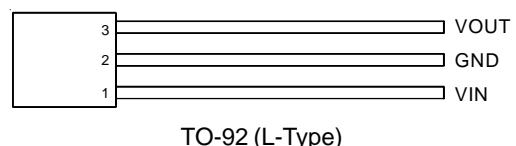
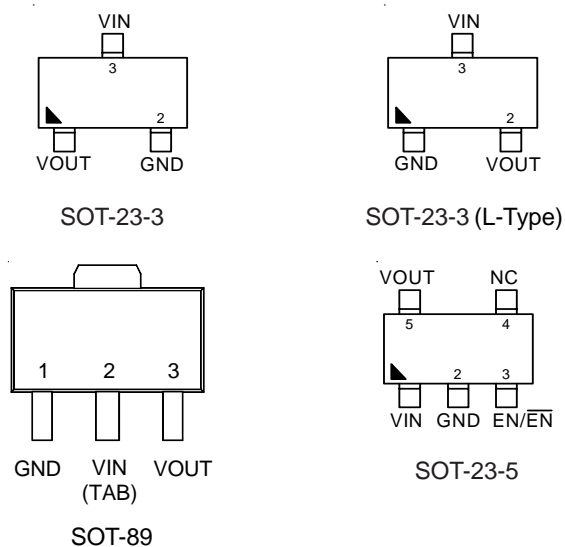

Typical Application Circuit

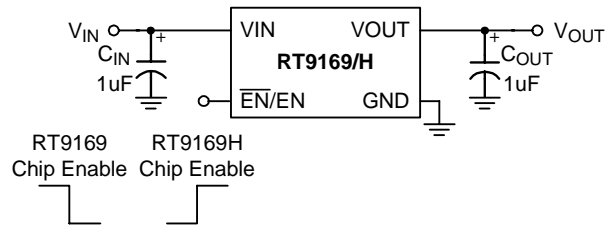
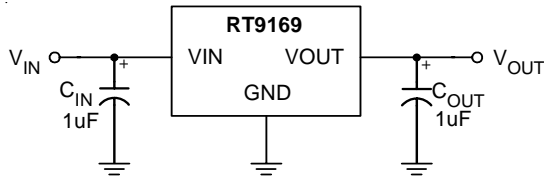

Function Block Diagram

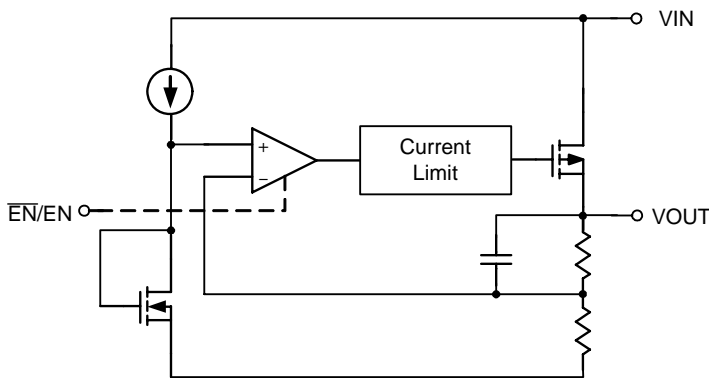

Functional Pin Description

Pin Name	Pin Function
VIN	Power Input
VOUT	Output Voltage
GND	Ground
EN/EN	Chip Enable Control Input

Absolute Maximum Ratings (Note 1)

- Input Voltage ----- 7V
- Power Dissipation, P_D @ $T_A = 25^\circ\text{C}$
 - SOT-23-3 ----- 0.4W
 - SOT-23-5 ----- 0.4W
 - SOT-89 ----- 0.571W
 - TO-92 ----- 0.625W
- Junction Temperature ----- 150°C
- Lead Temperature (Soldering, 10 sec.) ----- 260°C
- Storage Temperature Range ----- -65°C to 150°C
- Package Thermal Resistance (Note 2)
 - SOT-23-3, θ_{JA} ----- 250°C/W
 - SOT-23-5, θ_{JA} ----- 250°C/W
 - SOT-89, θ_{JA} ----- 175°C/W
 - TO-92, θ_{JA} ----- 160°C/W
- ESD Susceptibility (Note 3)
 - HBM (Human Body Mode) ----- 2kV
 - MM (Machine Mode) ----- 200V

Recommended Operating Conditions (Note 4)

- Junction Temperature Range ----- -40°C to 125°C
- Ambient Temperature Range ----- -40°C to 85°C

Electrical Characteristics

($V_{IN} = 5.5V$, $C_{IN} = 1\mu F$, $C_{OUT} = 1\mu F$, $T_A = 25^\circ C$, unless otherwise specified)

Parameter	Symbol	Test Conditions	Min	Typ	Max	Unit
Input Voltage Range	V_{IN}		2	--	6	V
Output Voltage Accuracy	ΔV_{OUT}	$I_L = 1mA$	-2	--	+2	%
Maximum Output Current	I_{MAX}	$V_{IN} = V_{OUT} + 0.6V$, $V_{IN} \geq 3.6V$	100	--	--	mA
Current Limit	I_{LIM}	$I_L = 100mA$	150	250	--	mA
GND Pin Current	I_G	No Load	--	4	7	μA
		$I_{OUT} = 100mA$		4	10	μA
Dropout Voltage	V_{DROP}	$I_{OUT} = 1mA$, $V_{IN} \geq 3.6V$	--	4	10	mV
		$I_{OUT} = 50mA$, $V_{IN} \geq 3.6V$	--	200	300	
		$I_{OUT} = 100mA$, $V_{IN} \geq 3.6V$	--	450	600	
Line Regulation	ΔV_{LINE}	$V_{IN} = (V_{OUT} + 0.3V)$ to $6V$, $V_{IN} \geq 3.6V$, $I_{OUT} = 1mA$	-0.2	--	+0.2	%/V
Load Regulation	ΔV_{LOAD}	$I_{LOAD} = 0mA$ to $100mA$	--	0.01	0.04	%/mA
Output Noise	e_{NO}	BW = 100Hz to 50kHz $C_{OUT} = 10\mu F$	--	250	--	μV
Ripple Rejection	PSRR	$F = 1kHz$, $C_{OUT} = 1\mu F$	--	30	--	dB
Standby Current	RT9169/H (SOT-23-5)	$\overline{EN} = V_{IN}$ or $EN = 0$	--	0.1	1	μA
EN/EN Threshold	Logic High	V_{IL}	0.6	--	--	V
	Logic Low	V_{IH}	--	--	2	
Thermal Shutdown Protection			125	--	--	$^\circ C$

Note 1. Stresses listed as the above "Absolute Maximum Ratings" may cause permanent damage to the device. These are for stress ratings. Functional operation of the device at these or any other conditions beyond those indicated in the operational sections of the specifications is not implied. Exposure to absolute maximum rating conditions for extended periods may remain possibility to affect device reliability.

Note 2. θ_{JA} is measured in the natural convection at $T_A = 25^\circ C$ on a low effective thermal conductivity test board of JEDEC 51-3 thermal measurement standard.

Note 3. Devices are ESD sensitive. Handling precaution is highly recommended.

Note 4. The device is not guaranteed to function outside its operating conditions.

Application Information

A $1\mu F$ (or larger) capacitor is recommended between V_{OUT} and GND for stability. The part may oscillate without the capacitor. Any type of capacitor can be used, but not Aluminum electrolytes when operating below $-25^\circ C$. The capacitance may be increased without limit.

A $1\mu F$ capacitor (or larger) should be placed between V_{IN} to GND.

Typical Operating Characteristics

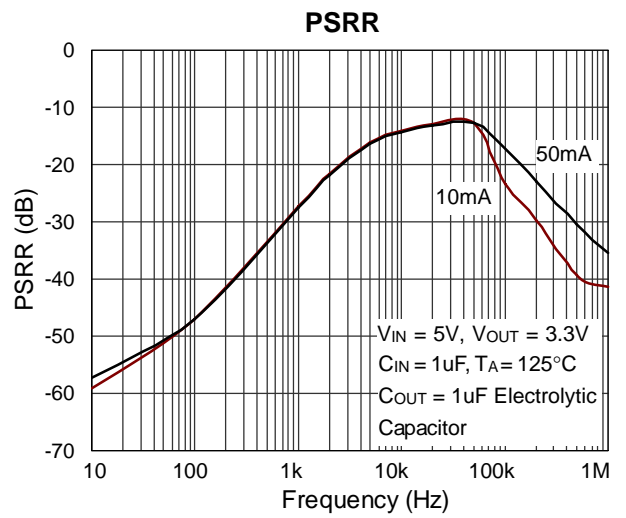
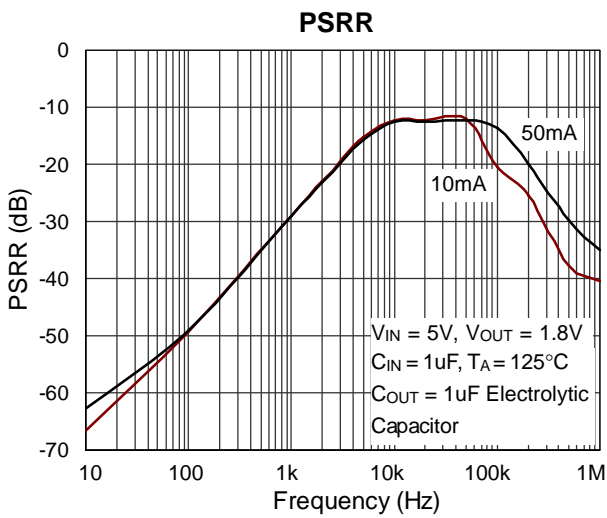
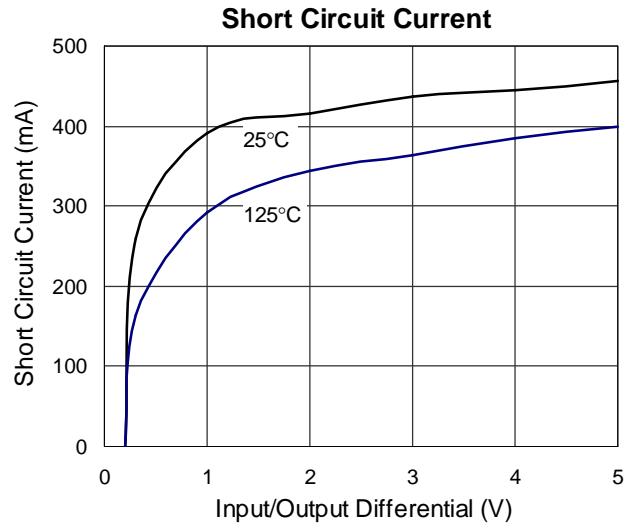
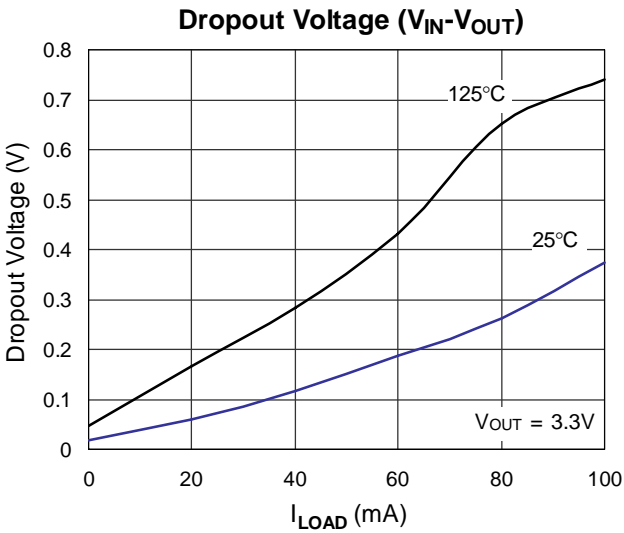
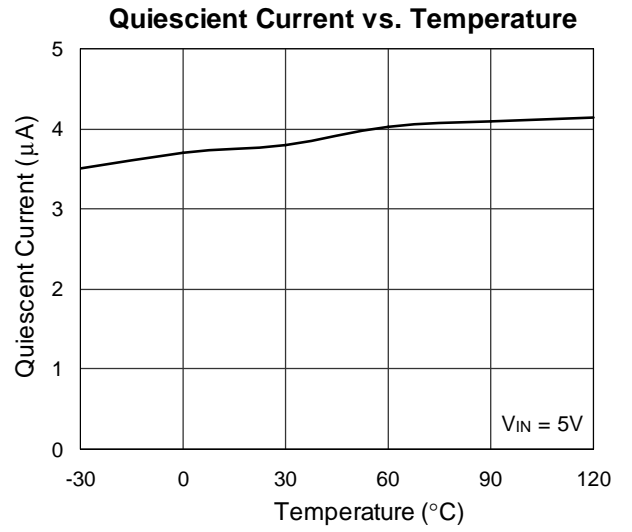
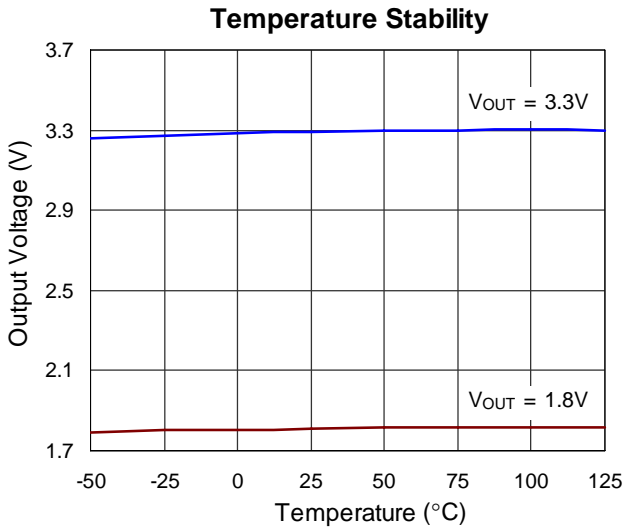

Line Transient Response

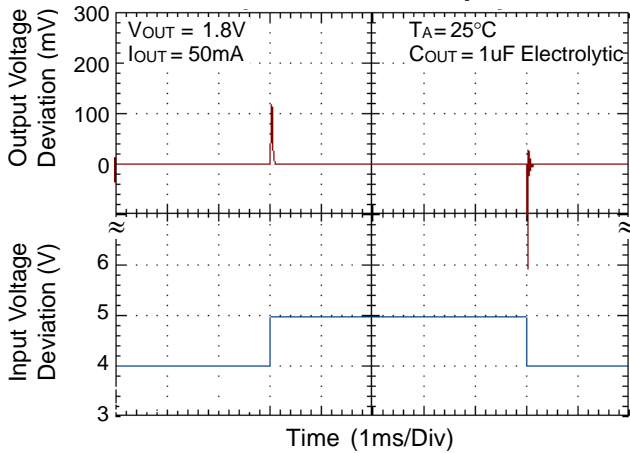

Line Transient Response

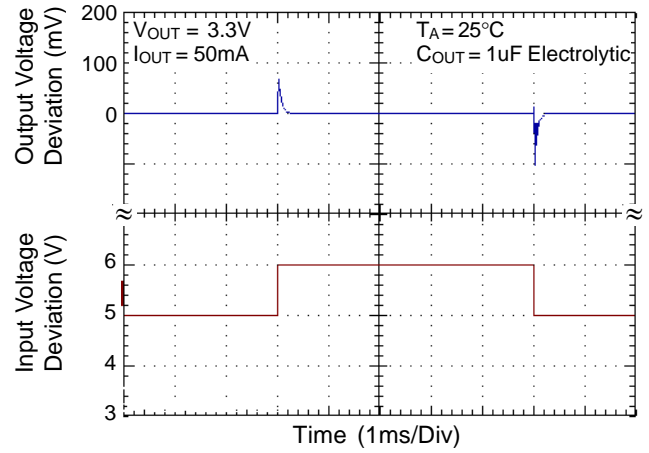

Load Transient Response

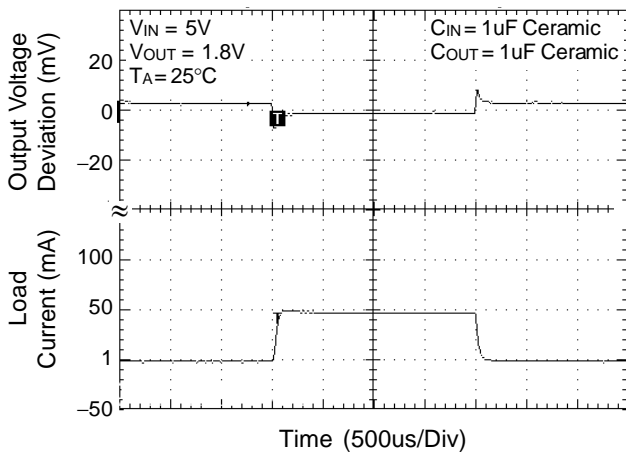

Load Transient Response

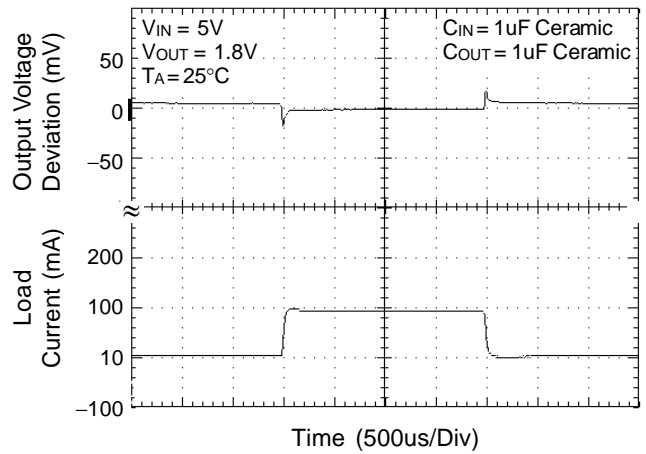

Load Transient Response

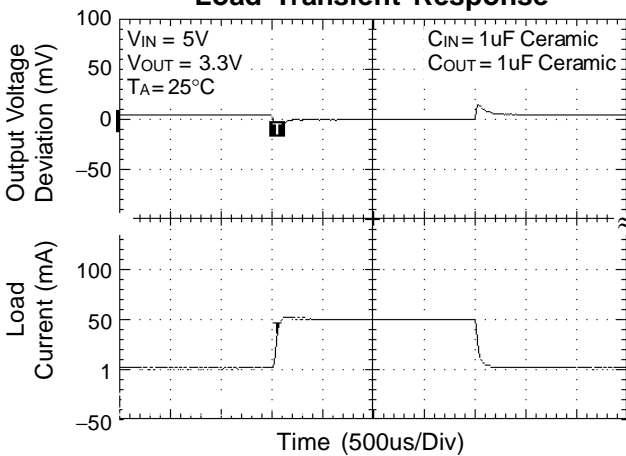

Load Transient Response

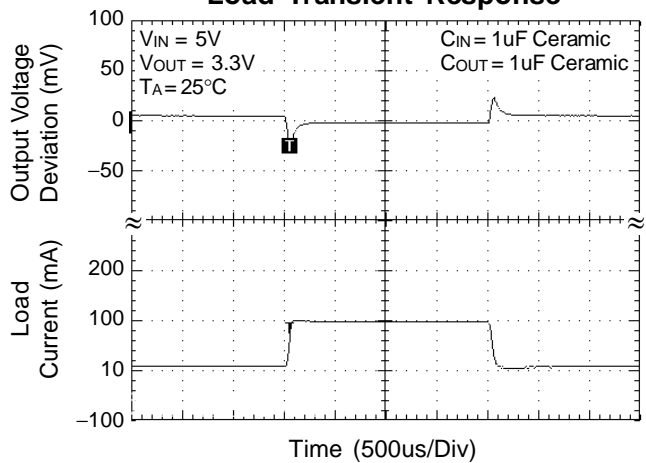

Outline Dimension

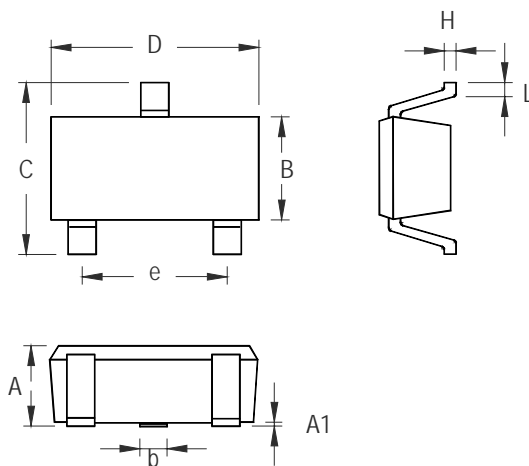

Symbol	Dimensions In Millimeters		Dimensions In Inches	
	Min	Max	Min	Max
A	0.889	1.295	0.035	0.051
A1	0.000	0.152	0.000	0.006
B	1.397	1.803	0.055	0.071
b	0.356	0.508	0.014	0.020
C	2.591	2.997	0.102	0.118
D	2.692	3.099	0.106	0.122
e	1.803	2.007	0.071	0.079
H	0.080	0.254	0.003	0.010
L	0.300	0.610	0.012	0.024

SOT-23-3 Surface Mount Package

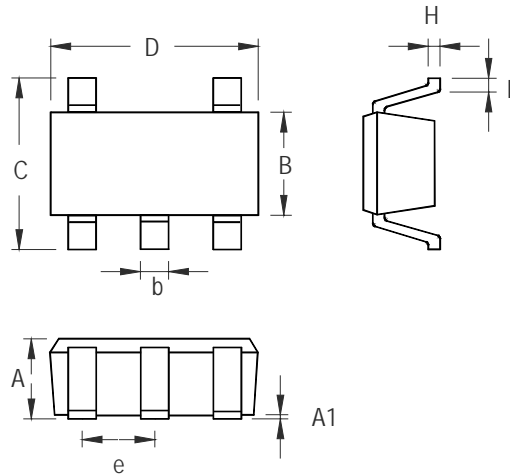

Symbol	Dimensions In Millimeters		Dimensions In Inches	
	Min	Max	Min	Max
A	0.889	1.295	0.035	0.051
A1	0.000	0.152	0.000	0.006
B	1.397	1.803	0.055	0.071
b	0.356	0.559	0.014	0.022
C	2.591	2.997	0.102	0.118
D	2.692	3.099	0.106	0.122
e	0.838	1.041	0.033	0.041
H	0.080	0.254	0.003	0.010
L	0.300	0.610	0.012	0.024

SOT-23-5 Surface Mount Package

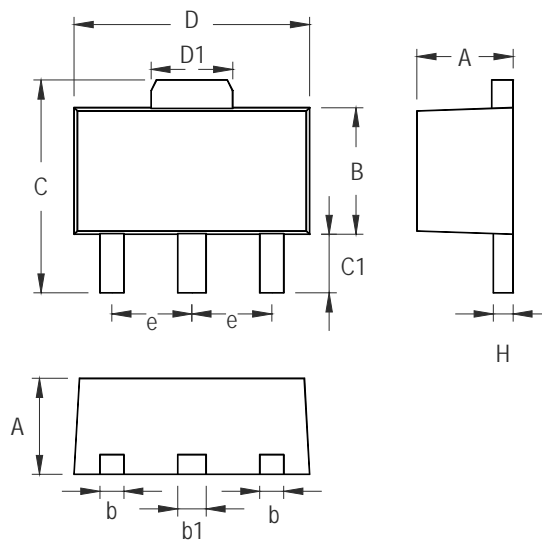

Symbol	Dimensions In Millimeters		Dimensions In Inches	
	Min	Max	Min	Max
A	1.397	1.600	0.055	0.063
b	0.356	0.483	0.014	0.019
B	2.388	2.591	0.094	0.102
b1	0.406	0.533	0.016	0.021
C	3.937	4.242	0.155	0.167
C1	0.787	1.194	0.031	0.047
D	4.394	4.597	0.173	0.181
D1	1.397	1.753	0.055	0.069
e	1.448	1.549	0.057	0.061
H	0.356	0.432	0.014	0.017

3-Lead SOT-89 Surface Mount Package

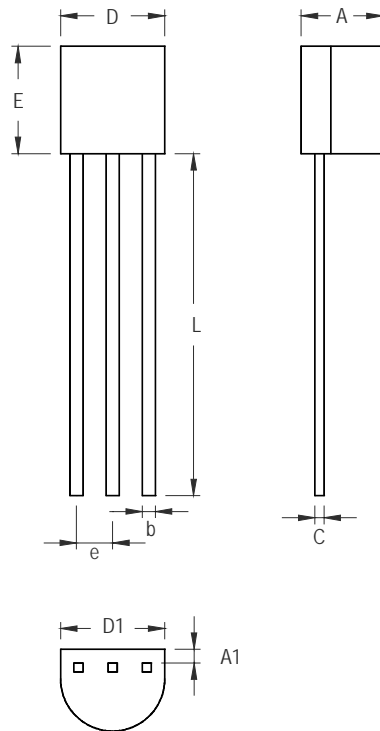

Symbol	Dimensions In Millimeters		Dimensions In Inches	
	Min	Max	Min	Max
A	3.175	4.191	0.125	0.165
A1	1.143	1.372	0.045	0.054
b	0.406	0.533	0.016	0.021
C	0.406	0.533	0.016	0.021
D	4.445	5.207	0.175	0.205
D1	3.429	5.029	0.135	0.198
E	4.318	5.334	0.170	0.210
e	1.143	1.397	0.045	0.055
L	12.700		0.500	

3-Lead TO-92 Plastic Package

Richtek Technology Corporation

Headquarter
 5F, No. 20, Taiyuen Street, Chupei City
 Hsinchu, Taiwan, R.O.C.
 Tel: (8863)5526789 Fax: (8863)5526611

Richtek Technology Corporation

Taipei Office (Marketing)
 5F, No. 95, Minchiuan Road, Hsintien City
 Taipei County, Taiwan, R.O.C.
 Tel: (8862)86672399 Fax: (8862)86672377
 Email: marketing@richtek.com

Information that is provided by Richtek Technology Corporation is believed to be accurate and reliable. Richtek reserves the right to make any change in circuit design, specification or other related things if necessary without notice at any time. No third party intellectual property infringement of the applications should be guaranteed by users when integrating Richtek products into any application. No legal responsibility for any said applications is assumed by Richtek.

Looking for pricing, stock, or lifecycle information?

Click below to explore more details on WIN SOURCE:

 [View RT9169H-28GB on WIN SOURCE](#)

 [Richtek USA Inc. Information](#)

Optimize Your Supply Chain with WIN SOURCE Solutions

-  Global Sourcing Solution
-  Obsolete Management
-  Cost Control Management
-  Shortage Management
-  Alternative Solution
-  Excess Inventory Management