



**THE DATASHEET OF
SM2518-1R0MHF**





Hologen Free

SM2518 Series



1. Features of SM2518 series:

- Molded inductor structure. No audible noise.
- 7.24 x 6.72mm / 7.40 x 6.80mm Foot Print , 5.0mm Max. height SMD Power Inductor for high frequency application. Operating frequency up to 5MHz.
- Inductance range from 0.22uH to 1.00 uH. Custom values are welcomed.
- High saturation current from distributed gap metal dust core.
- Ideal for DC/DC converters, PDA, Notebook and Server Application.
- Operating Temperature Range: -55°C to 150°C .
- T & R Qtys: 500 pcs , 13" Reel and Plastic tape: 16mm wide, 12mm pocket spacing.
- RoHS and HF Compliant.



2. Electrical Characteristics of SM2518 series:

ITG Part Number	Inductance ¹	DCR	DCR	Isat1 ²	Isat2 ³	Irms ⁴	Size Code
	(uH) ± 20%	(mΩ) Typ. @25°C	(mΩ) Max. @25°C	(A) @25°C	(A) @25°C	(A) @25°C	
SM2518-R22MHF	0.22	1.20	1.40	30.00	50.00	30.00	S2
SM2518-R47MHF	0.47	2.60	2.90	24.00	32.00	21.00	S2
SM2518-R56MHF	0.56	3.40	3.60	18.00	23.00	20.00	S1
SM2518-1R0MHF	1.00	5.60	6.50	15.00	17.00	13.00	S1

3. Mechanical Dimensions of SM2518 series (unit: mm):

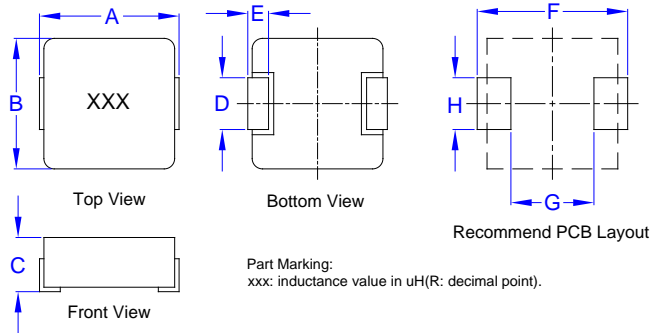

Series Name	F	G	H
SM2518-R22MHF~R47MHF	7.90	3.70	3.50
SM2518-R56MHF~1R0MHF	7.37	3.71	3.43

Size Code	A	B	C	D	E
S1	6.86 ± 0.38	6.47 ± 0.25	5.00 Max.	3.18 ± 0.30	1.30 ± 0.30
S2	7.40 Max.	6.60 ± 0.20	5.00 Max.	3.00 ± 0.50	1.30 ± 0.30

Notes:

1. Test conditions: 100KHz, 0.25V, 25°C ambient temperature .
 2. Isat1: DC current that causes inductance to drop 20%(Typ.) from OCL (Ta=25°C).
 3. Isat2: DC current that causes inductance to drop 30%(Typ.) from OCL (Ta=25°C).
 4. Irms: DC current for an approximate temperature rise of 40°C without core loss. Derating is necessary for AC currents.
- PCB pad layout,trace thickness and width,air-flow and proximity of other heat generating components will affect the temperature rise.
It is recommended the part temperature not exceed 125° C under worst case operating conditions as verified in the end application.

● New York 1 914 347 2474 ● Taipei 886 2 2698 8669 ● Kaohsiung 886 7 350 2275
 ● Tokyo 81 568 85 2830 ● Shenzhen 86 755 8418 6263 ● Shanghai 86 21 5424 5141 ● Hong Kong 852 9688 9767
 ● sales@ITG-Electronics.com ● www.ITG-Electronics.com Revision D.0: October 24 , 2022

*Due to continuous product improvement, all specifications are subject to change without prior notice. Kindly contact an ITG field application engineer or a sales representative prior to purchase.

4. Inductance vs. Current vs. Temperature Rise Characteristics of SM2518 Series :

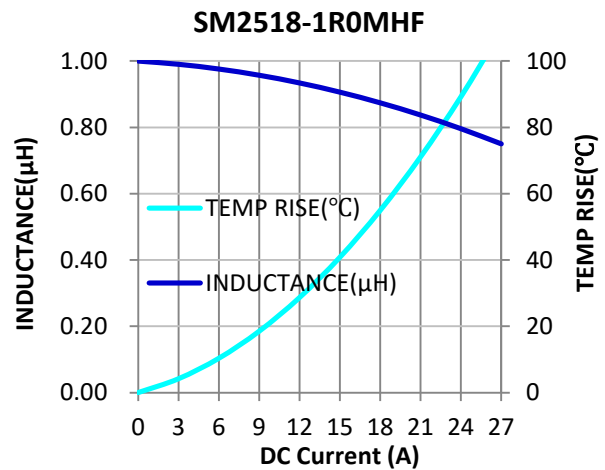
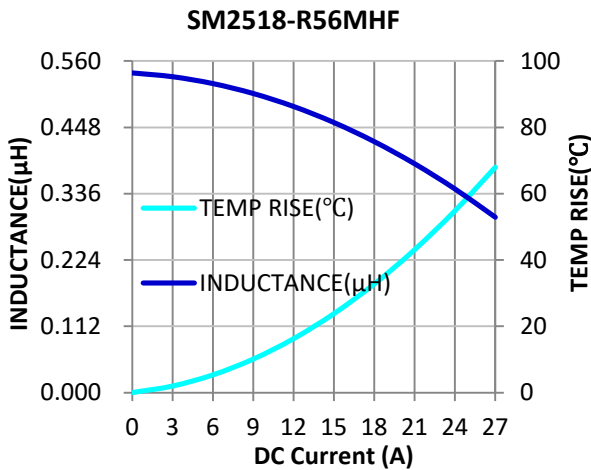
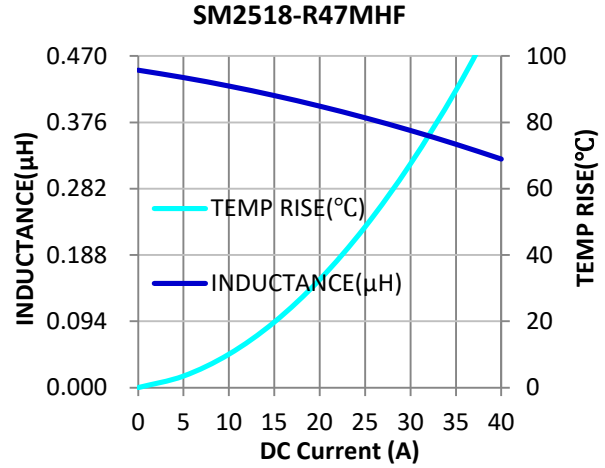
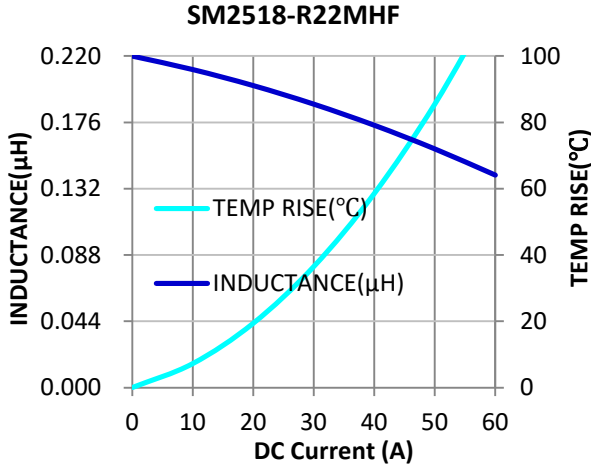

5. PACKAGE SPECIFICATION.(UNIT:mm):

(1).ENCAPSULATION MODE:

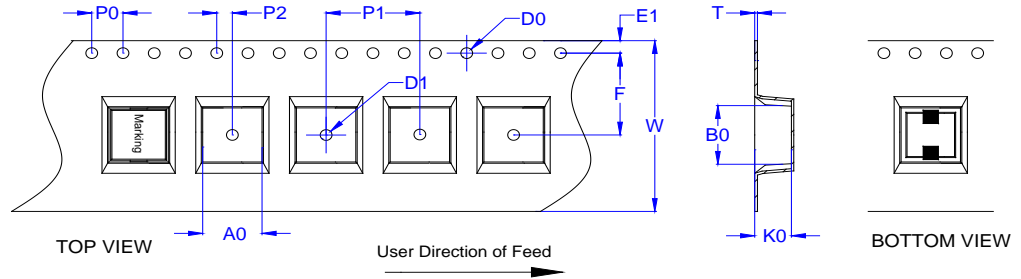

(2).DIMENSION(mm):

W	A0	B0	K0	P1	P0	P2	D0	D1	F	E1	T
16.0±0.30	7.2±0.10	7.5±0.10	5.60±0.15	12.0±0.10	4.0±0.10	2.0±0.10	1.5±0.10	1.5±0.10	7.5±0.10	1.75±0.10	0.40±0.10

(3).REEL SIZE:

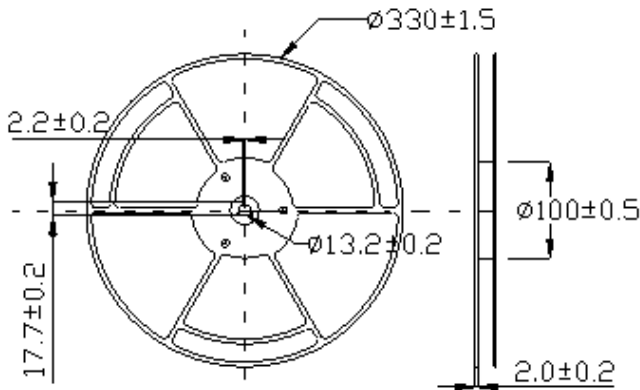

(4).PACKAGE MODE:

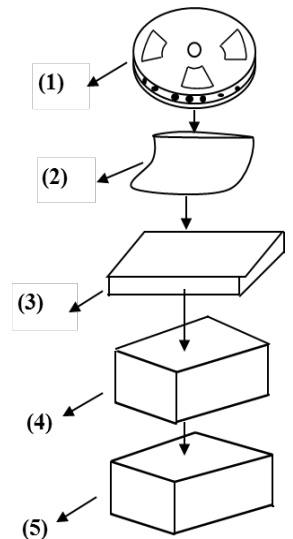

(5).PACKAGING LIST:

No.	Packing Part	Dimension (mm)	Material	Quantity
1	Reel	330	Plastic	500PCS / Reel
2	Bag	450 X 360 X 0.075	Plastic	1Reel / Bag
3	Pizza Box	340 X 335 X 45	Paper	2Bag / Pizza Box
4	Outer Box	356 X 350 X 226	Paper	4Pizza Box / Outer Box

(6).WEIGHT: N.W: 1.06 g/pc (APPROX), TOTAL 4.24 Kg(APPROX),G.W:TOTAL 9.24Kg (APPROX).

(7).Storage conditions: 20°C~35°C ,75%RH (Max.).

6.RELIABILITY TEST:

6.1 Mechanical Reliability		
Item	Specification and Requirement	Test Method and Remarks
Solderability	The surface of terminal immersed shall be minimum of 95% covered with a new coating of solder	According to J-STD-002 Method D category 3 1. Preheating: 160 ± 10 °C 2.Solder: 99.3%Sn/0.7%Cu , Flux: Rosin 3. Retention time: 255 ± 5 °C for 5 ± 0.5 seconds
Resistance to Soldering Heat	Inductance change: Within ±10% Without mechanical damage such as break	According to MIL-STD-202 Method 210 condition J 1.Solder: 99.3%Sn/0.7%Cu 2.Reflow Peak 235 ± 5°C(30±5s)/Time above 183°C(90~120s)
Vibration	Inductance change: Within ± 10% Without mechanical damage such as break	According to MIL-STD-202 Method 204 5g's for 20 minutes, 12 cycles each of 3 orientations. Note: Use 8"X5" PCB, .031" thick, 7 secure points on one long side and 2 secure points at corners of opposite sides. Parts mounted within 2" from any secure point. Test from 10-2000 Hz.
Shock	Inductance change: Within ±10% Without mechanical damage such as break	According to MIL-STD-202 Method 213 1. Peak value: 100 G 2. Duration of pulse: 11ms 3. 3 times in each positive and negative direction of 3 mutual perpendicular directions.
6.2 Endurance Reliability		
Thermal Shock	Inductance change: Within ± 10% Without distinct damage in appearance	According to IEC68-2-14 Method N(Nb) 1. Repeat 100 cycles as follow: (-55 ± 2 °C; 30 ± 3 min) → (Room temp., 5 min) → (+125 ± 2 °C, 30 ± 3 min) → (Room temp., 1 min) 2. Recovery: 48 + 4 / -0 hours of recovery under the standard condition after the test.
High Temperature & Humidity	Inductance change: Within ± 10% Without distinct damage in appearance	According to MIL-STD-202 Method 103 240 hours 85°C/85%RH. Unpowered. Measurement at 24±4 hours after test conclusion.
Low Temperature Store	Inductance change: Within ± 10% Without distinct damage in appearance	According to IEC68-2-1 Method A(Ad) Store temperature: -55 ± 2 °C, 1000 + 4 / -0 hours
High Temperature Store	Inductance change: Within ± 10% Without distinct damage in appearance	According to MIL-STD-202 Method 108 Store temperature: +125 ± 2 °C, 1000 + 4 / -0 hours

Soldering Reflow Chart

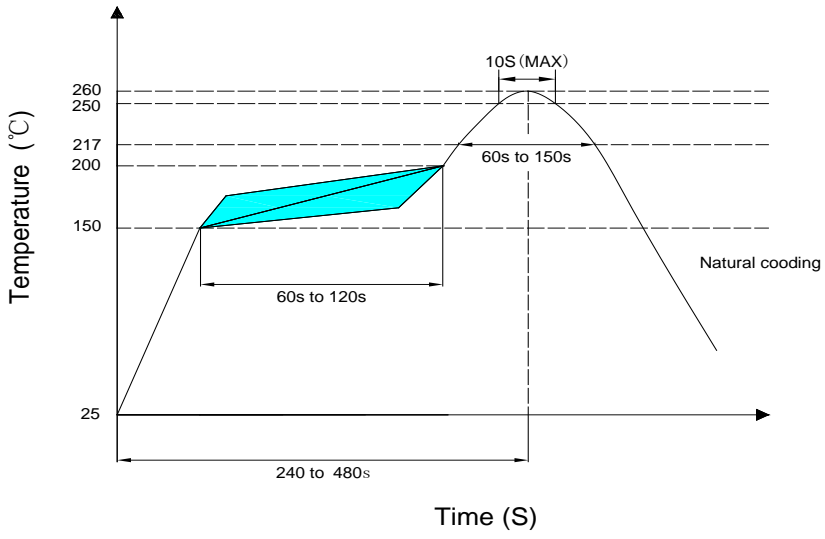
Stage	Precaution	Recommended temperature profile
Reflow soldering	<p>Temperature profile can be referenced after confirming of adhesion , temperature of resistance to soldering heat , component size , soldering etc. sufficient .</p> <p>Note: Please refer to the latest IPC/JEDEC J-STD-020: "Moisture/Reflow Sensitivity Classification for Nonhermetic Solid State Surface Mount Devices"</p>	 <p>The chart shows a reflow temperature profile with the following parameters:</p> <ul style="list-style-type: none"> Start temperature: 25°C Preheat ramp: 25°C to 150°C (60s to 120s) Soak ramp: 150°C to 200°C (60s to 150s) Peak temperature: 250°C (10s MAX) Cooling: Natural cooling Total time: 240 to 480s







Looking for pricing, stock, or lifecycle information?

Click below to explore more details on WIN SOURCE:

 [View SM2518-1R0MHF on WIN SOURCE](#)

 [ITG Electronics, Inc. Information](#)

Optimize Your Supply Chain with WIN SOURCE Solutions

-  Global Sourcing Solution
-  Obsolete Management
-  Cost Control Management
-  Shortage Management
-  Alternative Solution
-  Excess Inventory Management