



**THE DATASHEET OF  
SM6S10AHE3\_A/I**



# Surface Mount PAR<sup>®</sup> Transient Voltage Suppressors

High Temperature Stability and High Reliability Conditions



**DO-218AB**

Cathode Anode

PRIMARY CHARACTERISTICS	
$V_{WM}$	10 V to 36 V
$V_{BR}$	11.1 V to 44.2 V
$P_{PPM}$ (10 x 1000 $\mu$ s)	4600 W
$P_{PPM}$ (10 x 10 000 $\mu$ s)	3600 W
$P_D$	6 W
$I_{FSM}$	600 A
$T_J$ max.	175 °C
Polarity	Unidirectional
Package	DO-218AB

## FEATURES

- Junction passivation optimized design passivated anisotropic rectifier technology
- $T_J = 175$  °C capability suitable for high reliability and automotive requirement
- Available in unidirectional polarity only
- Low leakage current
- Low forward voltage drop
- High surge capability
- Meets ISO7637-2 surge specification (varied by test condition)
- Meets MSL level 1, per J-STD-020, LF maximum peak of 245 °C
- AEC-Q101 qualified
- Material categorization: for definitions of compliance please see [www.vishay.com/doc?99912](http://www.vishay.com/doc?99912)



**RoHS**  
COMPLIANT

## TYPICAL APPLICATIONS

Use in sensitive electronics protection against voltage transients induced by inductive load switching and lighting, especially for automotive load dump protection application.

## MECHANICAL DATA

**Case:** DO-218AB

Molding compound meets UL 94 V-0 flammability rating  
Base P/NHE3\_X - RoHS-compliant and AEC-Q101 qualified ("X" denotes revision code e.g. A, B, ...)

**Terminals:** matte tin plated leads, solderable per J-STD-002 and JESD 22-B102

HE3 suffix meets JESD 201 class 2 whisker test

**Polarity:** heatsink is anode

MAXIMUM RATINGS ( $T_C = 25$ °C unless otherwise noted)			
PARAMETER	SYMBOL	VALUE	UNIT
Peak pulse power dissipation	$P_{PPM}$	with 10/1000 $\mu$ s waveform	4600
		with 10/10 000 $\mu$ s waveform	3600
Power dissipation on infinite heatsink at $T_C = 25$ °C (fig. 1)	$P_D$	6.0	W
Peak pulse current with 10/1000 $\mu$ s waveform	$I_{PPM}^{(1)}$	See next table	A
Peak forward surge current 8.3 ms single half sine-wave	$I_{FSM}$	600	A
Operating junction and storage temperature range	$T_J, T_{STG}$	-55 to +175	°C

### Note

(1) Non-repetitive current pulse at  $T_A = 25$  °C



<b>ELECTRICAL CHARACTERISTICS</b> ( $T_C = 25\text{ }^\circ\text{C}$ unless otherwise noted)										
DEVICE TYPE	BREAKDOWN VOLTAGE $V_{BR}$ (V)			TEST CURRENT $I_T$ (mA)	STAND-OFF VOLTAGE $V_{WM}$ (V)	MAXIMUM REVERSE LEAKAGE AT $V_{WM}$ $I_D$ ( $\mu\text{A}$ )	MAXIMUM REVERSE LEAKAGE AT $V_{WM}$ $T_J = 175\text{ }^\circ\text{C}$ $I_D$ ( $\mu\text{A}$ )	MAX. PEAK PULSE CURRENT AT 10/1000 $\mu\text{s}$ WAVEFORM (A)	MAXIMUM CLAMPING VOLTAGE AT $I_{PPM}$ $V_C$ (V)	TYPICAL TEMP. COEFFICIENT OF $V_{BR}$ $\alpha_T$ ( $\%/^\circ\text{C}$ )
	MIN.	NOM.	MAX.							
SM6S10A	11.1	11.7	12.3	5.0	10.0	15	250	271	17.0	0.069
SM6S11A	12.2	12.9	13.5	5.0	11.0	10	150	253	18.2	0.072
SM6S12A	13.3	14.0	14.7	5.0	12.0	10	150	231	19.9	0.074
SM6S13A	14.4	15.2	15.9	5.0	13.0	10	150	214	21.5	0.076
SM6S14A	15.6	16.4	17.2	5.0	14.0	10	150	198	23.2	0.078
SM6S15A	16.7	17.6	18.5	5.0	15.0	10	150	189	24.4	0.080
SM6S16A	17.8	18.8	19.7	5.0	16.0	10	150	177	26.0	0.081
SM6S17A	18.9	19.9	20.9	5.0	17.0	10	150	167	27.6	0.082
SM6S18A	20.0	21.1	22.1	5.0	18.0	10	150	158	29.2	0.083
SM6S20A	22.2	23.4	24.5	5.0	20.0	10	150	142	32.4	0.085
SM6S22A	24.4	25.7	26.9	5.0	22.0	10	150	130	35.5	0.086
SM6S24A	26.7	28.1	29.5	5.0	24.0	10	150	118	38.9	0.087
SM6S26A	28.9	30.4	31.9	5.0	26.0	10	150	109	42.1	0.088
SM6S28A	31.1	32.8	34.4	5.0	28.0	10	150	101	45.4	0.089
SM6S30A	33.3	35.1	36.8	5.0	30.0	10	150	95	48.4	0.090
SM6S33A	36.7	38.7	40.6	5.0	33.0	10	150	86	53.3	0.091
SM6S36A	40.0	42.1	44.2	5.0	36.0	10	150	79	58.1	0.091

**Notes**

- For all types maximum  $V_F = 1.9\text{ V}$  at  $I_F = 100\text{ A}$  measured on 8.3 ms single half sine-wave or equivalent square wave, duty cycle = 4 pulses per minute maximum

(1) To calculate  $V_{BR}$  vs. junction temperature, use the following formula:  $V_{BR}$  at  $T_J = V_{BR}$  at  $25\text{ }^\circ\text{C} \times (1 + \alpha_T \times (T_J - 25))$

<b>THERMAL CHARACTERISTICS</b> ( $T_C = 25\text{ }^\circ\text{C}$ unless otherwise noted)			
PARAMETER	SYMBOL	VALUE	UNIT
Typical thermal resistance, junction to case	$R_{\theta JC}$	0.95	$^\circ\text{C/W}$

<b>ORDERING INFORMATION</b> (Example)				
PREFERRED P/N	UNIT WEIGHT (g)	PREFERRED PACKAGE CODE	BASE QUANTITY	DELIVERY MODE
SM6S10AHE3_AI (1)	2.550	I	750	13" diameter plastic tape and reel, anode towards the sprocket hole

**Note**

(1) AEC-Q101 qualified



### RATINGS AND CHARACTERISTICS CURVES ( $T_A = 25\text{ }^\circ\text{C}$ unless otherwise noted)

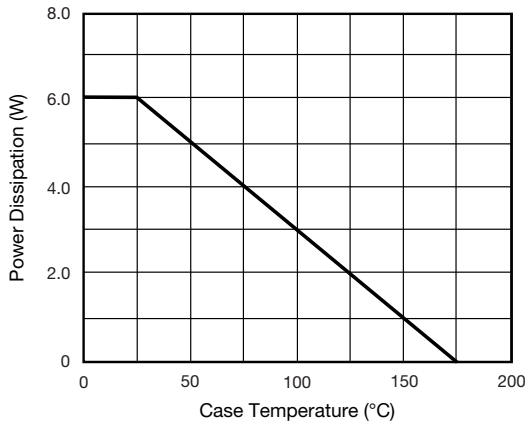

Fig. 1 - Power Derating Curve

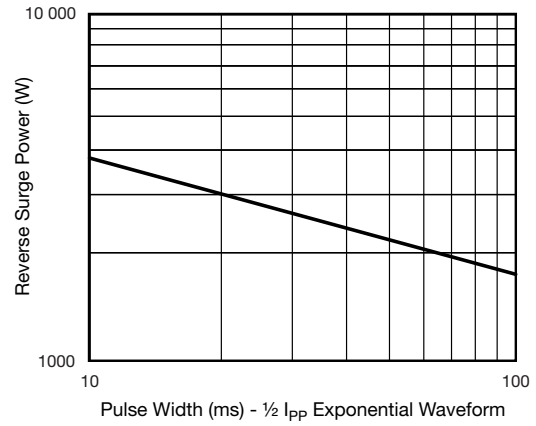

Fig. 4 - Reverse Power Capability

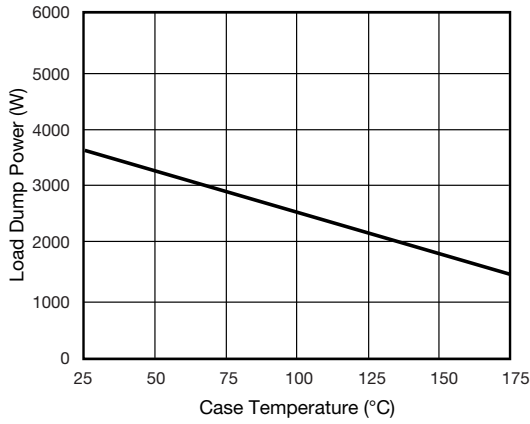

Fig. 2 - Load Dump Power Characteristics (10 ms Exponential Waveform)

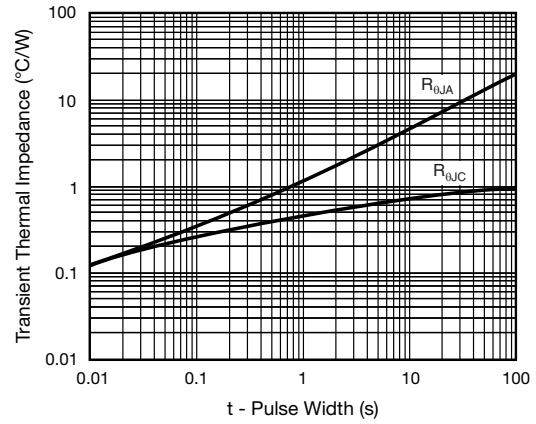

Fig. 5 - Typical Transient Thermal Impedance

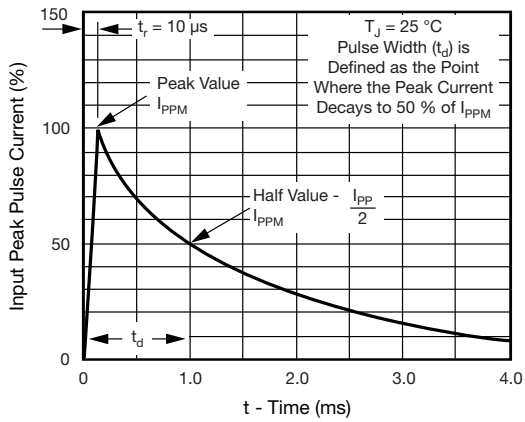
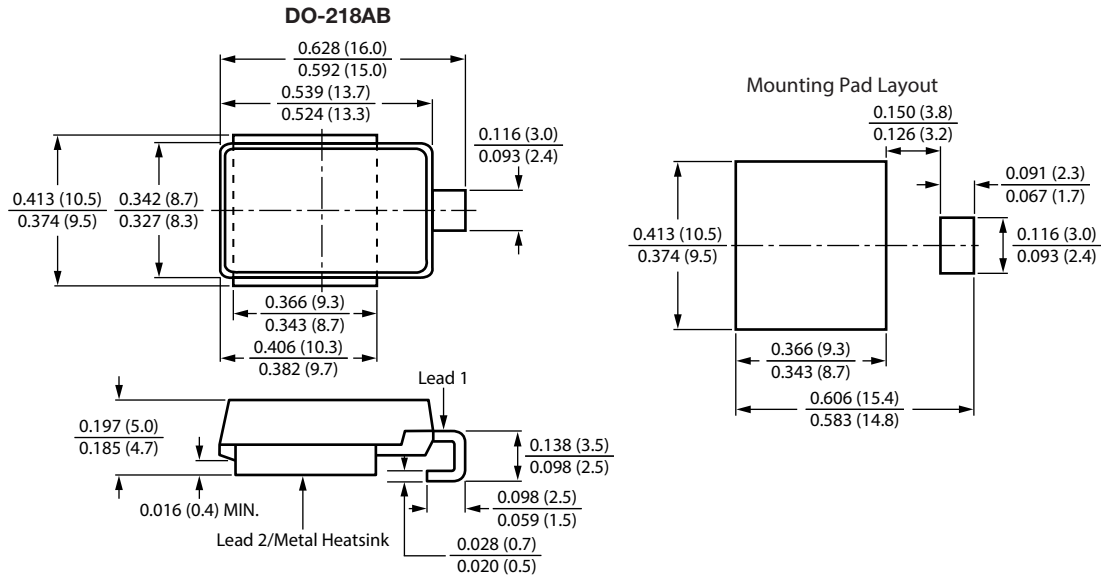

Fig. 3 - Pulse Waveform



### PACKAGE OUTLINE DIMENSIONS in inches (millimeters)





## Disclaimer

ALL PRODUCT, PRODUCT SPECIFICATIONS AND DATA ARE SUBJECT TO CHANGE WITHOUT NOTICE TO IMPROVE RELIABILITY, FUNCTION OR DESIGN OR OTHERWISE.

Vishay Intertechnology, Inc., its affiliates, agents, and employees, and all persons acting on its or their behalf (collectively, "Vishay"), disclaim any and all liability for any errors, inaccuracies or incompleteness contained in any datasheet or in any other disclosure relating to any product.

Vishay makes no warranty, representation or guarantee regarding the suitability of the products for any particular purpose or the continuing production of any product. To the maximum extent permitted by applicable law, Vishay disclaims (i) any and all liability arising out of the application or use of any product, (ii) any and all liability, including without limitation special, consequential or incidental damages, and (iii) any and all implied warranties, including warranties of fitness for particular purpose, non-infringement and merchantability.

Statements regarding the suitability of products for certain types of applications are based on Vishay's knowledge of typical requirements that are often placed on Vishay products in generic applications. Such statements are not binding statements about the suitability of products for a particular application. It is the customer's responsibility to validate that a particular product with the properties described in the product specification is suitable for use in a particular application. Parameters provided in datasheets and / or specifications may vary in different applications and performance may vary over time. All operating parameters, including typical parameters, must be validated for each customer application by the customer's technical experts. Product specifications do not expand or otherwise modify Vishay's terms and conditions of purchase, including but not limited to the warranty expressed therein.

Hyperlinks included in this datasheet may direct users to third-party websites. These links are provided as a convenience and for informational purposes only. Inclusion of these hyperlinks does not constitute an endorsement or an approval by Vishay of any of the products, services or opinions of the corporation, organization or individual associated with the third-party website. Vishay disclaims any and all liability and bears no responsibility for the accuracy, legality or content of the third-party website or for that of subsequent links.

Except as expressly indicated in writing, Vishay products are not designed for use in medical, life-saving, or life-sustaining applications or for any other application in which the failure of the Vishay product could result in personal injury or death. Customers using or selling Vishay products not expressly indicated for use in such applications do so at their own risk. Please contact authorized Vishay personnel to obtain written terms and conditions regarding products designed for such applications.

No license, express or implied, by estoppel or otherwise, to any intellectual property rights is granted by this document or by any conduct of Vishay. Product names and markings noted herein may be trademarks of their respective owners.

## Looking for pricing, stock, or lifecycle information?

Click below to explore more details on WIN SOURCE:

 [View SM6S10AHE3\\_AI on WIN SOURCE](#)

 [Vishay Information](#)

## Optimize Your Supply Chain with WIN SOURCE Solutions

-  Global Sourcing Solution
-  Obsolete Management
-  Cost Control Management
-  Shortage Management
-  Alternative Solution
-  Excess Inventory Management