



# THE DATASHEET OF STOD13AMTPUR



## 250 mA dual DC-DC converter for powering AMOLED displays

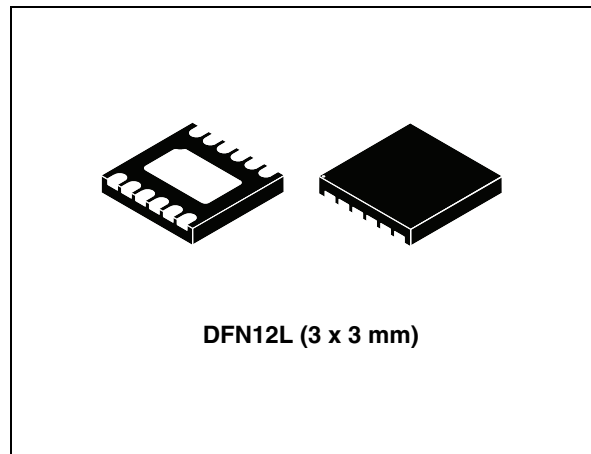
Datasheet – production data

### Features

- Step-up and inverter converters
- Operating input voltage range from 2.5 V to 4.5 V
- Synchronous rectification for both DC-DC converters
- Minimum 250 mA output current
- 4.6 V fixed positive output voltage
- Programmable negative voltage by  $S_{WIRE}$  from - 2.4 V to - 5.4 V at 100 mV steps
- Typical efficiency: 85%
- Pulse-skipping mode in light load condition
- 1.5 MHz PWM mode control switching frequency
- TDMA noise high immunity
- Enable pin for shutdown mode
- Low quiescent current in shutdown mode
- Soft-start with inrush current protection
- Overtemperature protection
- Temperature range: - 40 °C to 85 °C
- True-shutdown mode
- Fast discharge outputs of the circuits after shutdown
- Overload protection
- Short-circuit protection
- Package DFN12L (3 x 3 mm) 0.6 mm height

### Applications

- Active matrix OLED power supply in portable devices
- Cellular phones



- Camcorders and digital still cameras
- Multimedia players

### Description

The STOD13AM is a dual DC-DC converter for AMOLED display panels. It integrates a step-up and an inverting DC-DC converter making it particularly suitable for battery operated products, in which the major concern is overall system efficiency. It works in pulse-skipping mode during low load conditions and PWM mode at 1.5 MHz frequency for medium/high load conditions. The high frequency allows the value and size of external components to be reduced. The Enable pin allows the device to be turned off, therefore reducing the current consumption to less than 1  $\mu$ A. The negative output voltage can be programmed by an MCU through a dedicated pin which implements single-wire protocol. Soft-start with controlled inrush current limit, thermal shutdown, and short-circuit protection are integrated functions of the device.

**Table 1. Device summary**

Order code	Positive voltage	Negative voltage	Package	Packaging
STOD13AMTPUR	4.6 V	- 2.4 V to - 5.4 V	DFN12L (3 x 3 mm)	3000 parts per reel

# Contents

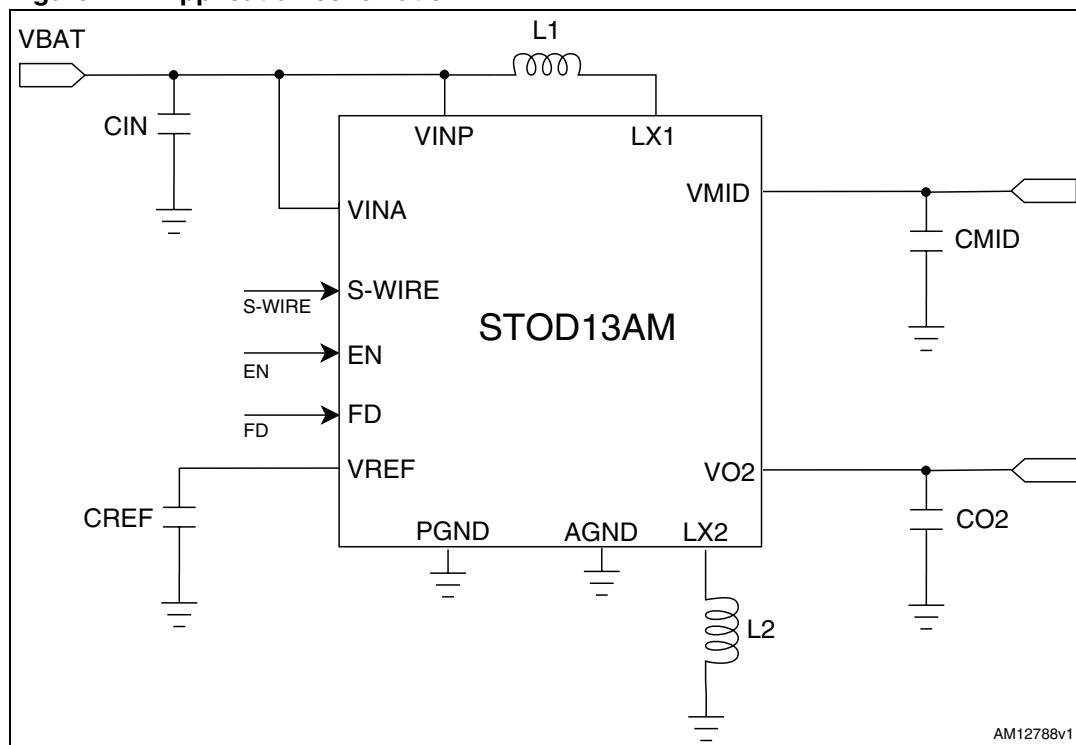
- 1 Schematic ..... 3**
- 2 Pin configuration ..... 5**
- 3 Maximum ratings ..... 6**
- 4 Electrical characteristics ..... 7**
- 5 Typical performance characteristics ..... 10**
- 6 Detailed description ..... 12**
  - 6.1 SWIRE ..... 12
    - 6.1.1 SWIRE features and benefits ..... 12
    - 6.1.2 SWIRE protocol ..... 12
    - 6.1.3 SWIRE basic operations ..... 12
  - 6.2 Negative output voltage levels ..... 12
  - 6.3 Enable, S<sub>WIRE</sub> and FD ..... 13
- 7 Application information ..... 14**
  - 7.1 External passive components ..... 14
    - 7.1.1 Inductor selection ..... 14
    - 7.1.2 Input and output capacitor selection ..... 14
  - 7.2 Recommended PCB layout ..... 15
- 8 Detailed description ..... 16**
  - 8.1 General description ..... 16
    - 8.1.1 Multiple operation modes ..... 16
    - 8.1.2 Pulse-skipping operation ..... 16
    - 8.1.3 Discontinuous conduction mode ..... 16
    - 8.1.4 Continuous conduction mode ..... 16
    - 8.1.5 Enable pin ..... 17
    - 8.1.6 Soft-start and inrush current limiting ..... 17
    - 8.1.7 Undervoltage lockout ..... 17
    - 8.1.8 Overtemperature protection ..... 17

---

8.1.9	Short-circuit protection during soft-start (SSD) .....	17
8.1.10	Overload protection (OLP) .....	17
8.1.11	Short-circuit protection (SCP) .....	18
8.1.12	Fast discharge .....	18
<b>9</b>	<b>Package mechanical data .....</b>	<b>19</b>
<b>10</b>	<b>Revision history .....</b>	<b>24</b>

# 1 Schematic

Figure 1. Application schematic



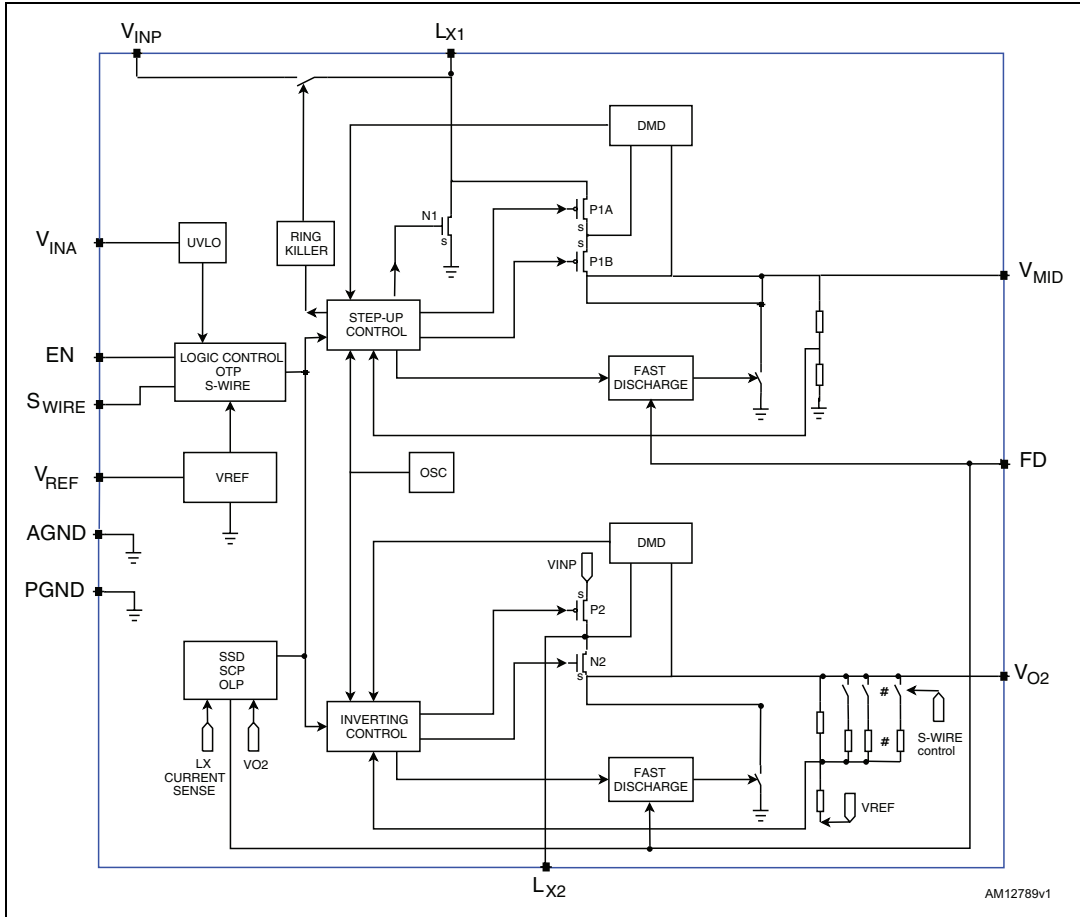
AM12788v1

Table 2. Typical external components

Comp.	Manufacturer	Part number	Value	Size	Ratings
L <sub>1</sub> (1)	CoilCraft Murata	LPS4012-472ML	4.7 μH	4.0 x 4.0 x 1.2	±20%, I = 1.7A, R = 0.175 Ω
		LQH3NPN4R7MM0		3.0 x 3.0 x 1.5	
L <sub>2</sub> (2)	CoilCraft Murata	LPS4012-472ML	4.7 μH	4.0 x 4.0 x 1.2	±20%, I = 1.7A, R = 0.175 Ω
		LQH3NPN4R7MM0		3.0 x 3.0 x 1.5	
C <sub>IN</sub>	Murata	GRM219R61A106KE44	2 x 10 μF	0805	±10%, X5R, 10 V
C <sub>MID</sub>	Murata	GRM219R61A106KE44	10 μF	0805	±10%, X5R, 10 V
C <sub>O2</sub>	Murata	GRM219R61A106KE44	2 x 10 μF	0805	±10%, X5R, 10 V
C <sub>REF</sub>	Murata	GRM185R60J105KE26	1 μF	0603	±10%, X5R, 6.3 V

1. A 250 mA load can be provided with inductor saturation current as a minimum of 0.9 A.
2. At - 5.4 V, a 250 mA load can be provided with inductor saturation current as a minimum of 1.4 A. See [Section 7.1.1](#).

Figure 2. Block schematic



## 2 Pin configuration

Figure 3. Pin configuration (top view)

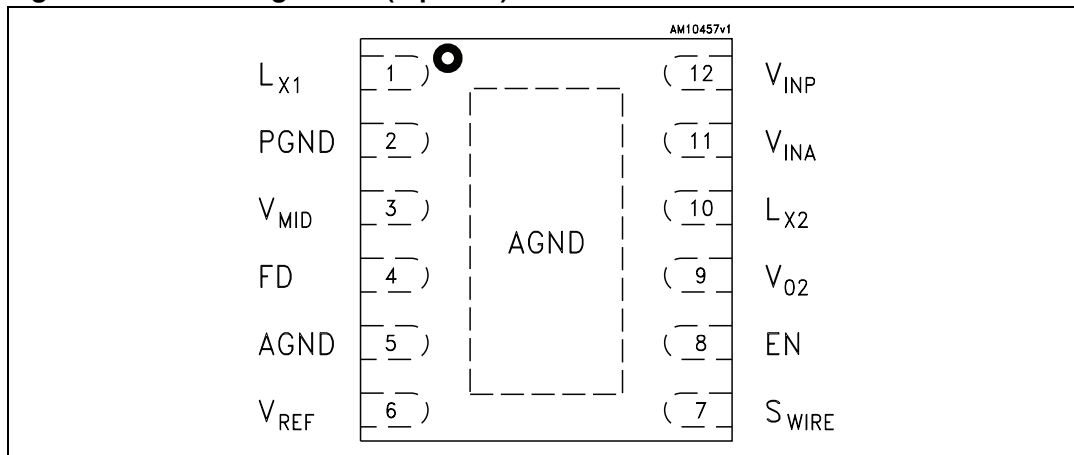


Table 3. Pin description

Pin	Pin n°	Description
L <sub>X1</sub>	1	Boost converter switching node
PGND	2	Power ground pin
V <sub>MID</sub>	3	Boost converter output voltage
FD	4	Fast discharge control pin. When pulled LOW, the fast discharge after shutdown is active. When pulled HIGH, the fast discharge is OFF
AGND	5	Signal ground pin. This pin must be connected to the power ground layer
V <sub>REF</sub>	6	Voltage reference output. 1 μF bypass capacitor must be connected between this pin and AGND
S <sub>WIRE</sub>	7	Negative voltage setting pin
EN	8	Enable control pin. High = converter on; Low = converter in shutdown mode
V <sub>O2</sub>	9	Inverting converter output voltage
L <sub>X2</sub>	10	Inverting converter switching node
V <sub>INA</sub>	11	Analogic input supply voltage
V <sub>INP</sub>	12	Power input supply voltage
	Exposed pad	Internally connected to AGND. Exposed pad must be connected to ground layers in the PCB layout in order to guarantee proper operation of the device

### 3 Maximum ratings

**Table 4. Absolute maximum ratings**

Symbol	Parameter	Value	Unit
$V_{INA}, V_{INP}$	DC supply voltage	-0.3 to 6	V
EN, $S_{WIRE}$	Logic input pins	-0.3 to 4.6	V
FD	Logic input pin	-0.3 to $V_{INA} + 0.3$	V
$IL_{X2}$	Inverting converter switching current	Internally limited	A
$L_{X2}$	Inverting converter switching node voltage	-10 to $V_{INP} + 0.3$	V
$V_{O2}$	Inverting converter output voltage	-10 to AGND + 0.3	V
$V_{MID}$	Step-up converter and LDO output voltage	-0.3 to 6	V
$L_{X1}$	Step-up converter switching node voltage	-0.3 to $V_{MID} + 0.3$	V
$IL_{X1}$	Step-up converter switching current	Internally limited	A
$V_{REF}$	Reference voltage	-0.3 to 3	V
$P_D$	Power dissipation	Internally limited	mW
$T_{STG}$	Storage temperature range	-65 to 150	°C
$T_J$	Maximum junction temperature	150	°C
ESD	Human body model protection	±2	kV
	Machine body model protection	200	V

*Note:* Absolute maximum ratings are those values beyond which damage to the device may occur. Functional operation under these conditions is not implied.

The Lx1 and Lx2 have high slew rate and they can be above the absolute maximum rating during operation due to the parasitic inductance in the PCB and scope probe. An absolute maximum rating of Lx1 and Lx2 is related to voltage supplied by an external source so the internally generated Lx1 and Lx2 voltage during normal operation doesn't damage the chipset.

**Table 5. Thermal data**

Symbol	Parameter	Value	Unit
$R_{thJA}$	Thermal resistance junction-ambient	33	°C/W
$R_{thJC}$	Thermal resistance junction-case (FR-4 PCB) <sup>(1)</sup>	2.12	°C/W

1. The package is mounted on a 4-layer (2S2P) JEDEC board as per JESD51-7.

# 4 Electrical characteristics

$T_J = 25\text{ }^\circ\text{C}$ ,  $V_{INA} = V_{INP} = 3.7\text{ V}$ ,  $I_{MID,O2} = 30\text{ mA}$ ,  $C_{IN} = 2 \times 10\text{ }\mu\text{F}$ ,  $C_{MID} = 10\text{ }\mu\text{F}$ ,  
 $C_{O2} = 2 \times 10\text{ }\mu\text{F}$ ,  $C_{REF} = 1\text{ }\mu\text{F}$ ,  $L1 = L2 = 4.7\text{ }\mu\text{H}$ ,  $V_{EN} = 2\text{ V}$ ,  $V_{MID} = 4.6\text{ V}$ ,  $V_{O2} = -4.9\text{ V}$  unless otherwise specified.

**Table 6. Electrical characteristics**

Symbol	Parameter	Test conditions	Min.	Typ.	Max.	Unit
<b>General section</b>						
$V_{INA}, V_{INP}$	Supply input voltage		2.5	3.7	4.5	V
UVLO_H	Undervoltage lockout HIGH	$V_{INA}$ rising		2.22	2.25	V
UVLO_L	Undervoltage lockout LOW	$V_{INA}$ falling	1.9	2.18		V
$I_{-VI}$	Input current	No load condition		1.7	2.1	mA
$I_{Q\_SH}$	Shutdown current	$V_{EN}=V_{SW}=GND$ $T_J=-40\text{ }^\circ\text{C}$ to $+85\text{ }^\circ\text{C}$			1	$\mu\text{A}$
$V_{EN\ H}$	Enable high threshold	$V_{INA}=2.5\text{ V}$ to $4.5\text{ V}$ , $T_J=-40\text{ }^\circ\text{C}$ to $+85\text{ }^\circ\text{C}$	1.2			V
$V_{EN\ L}$	Enable low threshold				0.4	
$I_{EN}$	Enable input current	$V_{EN}=V_{INA}=4.5\text{ V}$ ; $T_J=-40\text{ }^\circ\text{C}$ to $+85\text{ }^\circ\text{C}$			1	$\mu\text{A}$
$V_{FD\ H}$	Fast discharge high threshold	$V_{INA}=2.5\text{ V}$ to $4.5\text{ V}$ , $T_J=-40\text{ }^\circ\text{C}$ to $+85\text{ }^\circ\text{C}$	1.2			V
$V_{FD\ L}$	Fast discharge low threshold				0.4	
$I_{FD}$	Fast discharge input current	$V_{FD}=V_{INA}=4.5\text{ V}$ ; $T_J=-40\text{ }^\circ\text{C}$ to $+85\text{ }^\circ\text{C}$			50	$\mu\text{A}$
fs	Switching frequency	PWM mode	1.35	1.5	1.65	MHz
D1_MAX	Step-up maximum duty cycle	No load		87		%
D2_MAX	Inverting maximum duty cycle	No load		87		%
	Total system efficiency	$I_{MID,O2}=10\text{ to }30\text{ mA}$ , $V_{MID}=4.6\text{ V}$ , $V_{O2}=-4.9\text{ V}$		78		%
		$I_{MID,O2}=30\text{ to }150\text{ mA}$ , $V_{MID}=4.6\text{ V}$ , $V_{O2}=-4.9\text{ V}$		85		
		$I_{MID,O2}=150\text{ to }250\text{ mA}$ , $V_{MID}=4.6\text{ V}$ , $V_{O2}=-4.9\text{ V}$		82		
$V_{REF}$	Reference voltage	$I_{REF}=10\text{ }\mu\text{A}$	1.208	1.220	1.232	V
$I_{REF}$	Reference current capability	@ 98.5% of no load reference voltage	100			$\mu\text{A}$
<b>Step-up converter section</b>						
$V_{MID}$	Positive output voltage			4.6		V
	Positive output voltage total variation	$V_{INA}=V_{INP}=2.9\text{ V}$ to $4.5\text{ V}$ ; $I_{MID}=5\text{ mA}$ to $250\text{ mA}$ , $I_{O2}$ no load $T_J = -40\text{ }^\circ\text{C}$ to $+85\text{ }^\circ\text{C}$	-0.8		0.8	%



Table 6. Electrical characteristics (continued)

Symbol	Parameter	Test conditions	Min.	Typ.	Max.	Unit
$\Delta V_{MID\ LT}$	Line transient	$V_{INA,P}=3.4\text{ V to }2.9\text{ V}$ , $I_{MID}=100\text{ mA}$ ; $T_R=T_F=10\ \mu\text{s}$		-10		mV
$\Delta V_{MID\ T}$	Load transient response	$I_{MID}=3\text{ to }30\text{ mA}$ and $I_{MID}=30$ to $3\text{ mA}$ , $T_R=T_F=150\ \mu\text{s}$		$\pm 20$		mV
		$I_{MID}=10\text{ to }100\text{ mA}$ and $I_{MID}=100\text{ to }10\text{ mA}$ , $T_R=T_F=150\ \mu\text{s}$		$\pm 25$		mV
TDMA Noise	Undershoot/overshoot	$I_{MID}=10\text{ to }50\text{ mA}$ ; $I_{O2}$ no load <sup>(1)</sup>		$\pm 20$		mV
	Static variation between low and high $V_{IN}$ level			4		
$I_{MID\ MAX}$	Maximum output current	$V_{INA,P}=2.9\text{ V to }4.5\text{ V}$	250			mA
$I-L_{1MAX}$	Step-up inductor peak current	$V_{MID}$ 10% below nominal value	1.08		1.32	A
<b>Step-up converter section</b>						
$R_{DSONP1}$	P-channel static drain-source on-resistance	$V_{INA}=V_{INP}=3.7\text{ V}$ , $I_{SW-P1}=100\text{ mA}$		1.0	2.0	$\Omega$
$R_{DSONN1}$	N-channel static drain-source on-resistance	$V_{INA}=V_{INP}=3.7\text{ V}$ , $I_{SW-N1}=100\text{ mA}$		0.4	1.0	$\Omega$
<b>Inverting converter section</b>						
$V_{O2}$	Negative output voltage range	41 different values set by $S_{WIRE}$ pin (see <a href="#">Section 6.1.2</a> )	-6.4		-2.4	V
	Negative output voltage			-4.9		V
	Negative output voltage total variation	$V_{INA}=V_{INP}=2.9\text{ V to }4.5\text{ V}$ ; $I_{O2}=5\text{ mA to }250\text{ mA}$ , $I_{MID}$ no load $T_J=-40\text{ }^\circ\text{C to }+85\text{ }^\circ\text{C}$	-1.7		1.7	%
$\Delta V_{O2\ LT}$	Line transient	$V_{INA,P}=3.4\text{ V to }2.9\text{ V}$ , $I_{O2}=100\text{ mA}$ , $T_R=T_F=10\ \mu\text{s}$		+10		mV
$\Delta V_{O2\ T}$	Load transient response	$I_{O2}=3\text{ to }30\text{ mA}$ and $I_{O2}=30$ to $3\text{ mA}$ , $T_R=T_F=150\ \mu\text{s}$		$\pm 20$		mV
		$I_{O2}=10\text{ to }100\text{ mA}$ and $I_{O2}=100\text{ to }10\text{ mA}$ , $T_R=T_F=150\ \mu\text{s}$		$\pm 25$		mV
TDMA Noise	Undershoot/overshoot	$I_{O2}=10\text{ to }50\text{ mA}$ ; $I_{MID}$ no load <sup>(1)</sup>		$\pm 20$		mV
	Static variation between low and high $V_{IN}$ level			5		
$I_{O2\ MAX}$	Maximum output current	$V_{INA,P}=2.9\text{ V to }4.5\text{ V}$	-250			mA
$I-L_{2MAX}$	Inverting peak current	$V_{O2}$ below 10% of nominal value	-1.6		-1.3	A
$R_{DSONP2}$	P-channel static drain-source on-resistance	$V_{INA}=V_{INP}=3.7\text{ V}$ , $I_{SW-P2}=100\text{ mA}$		0.42	0.8	$\Omega$

Table 6. Electrical characteristics (continued)

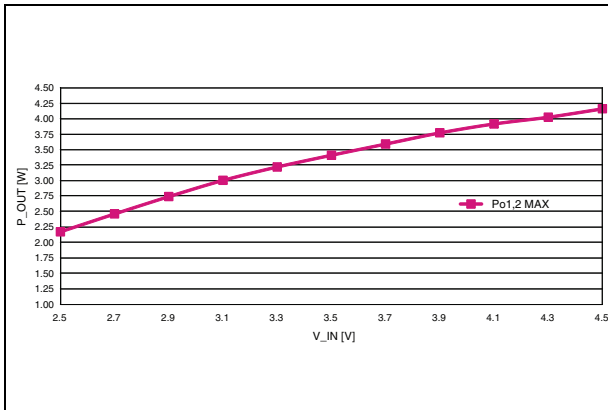
Symbol	Parameter	Test conditions	Min.	Typ.	Max.	Unit
$R_{\text{DSON}N2}$	N-channel static drain-source on-resistance	$V_{\text{INA}}=V_{\text{INP}}=3.7\text{ V}$ , $I_{\text{SW-N2}}=100\text{ mA}$		0.43	0.8	$\Omega$
<b>Thermal shutdown</b>						
OTP	Overtemperature protection			140		$^{\circ}\text{C}$
$\text{OTP}_{\text{HYST}}$	Overtemperature protection hysteresis			15		$^{\circ}\text{C}$
<b>Discharge resistor</b>						
$R_{\text{DIS}}$	Resistor value	No load, EN=SW=FD=Low		400		$\Omega$
$T_{\text{DIS}}$	Discharge time	No load, EN=SW=FD=Low, $V_{\text{MID}}-V_{\text{O2}}$ at 10% of nominal value		10		ms

1.  $V_{\text{INA,P}} = 4.2$  to  $3.7\text{ V}$ ,  $3.7$  to  $3.2\text{ V}$ ,  $3.4$  to  $2.9\text{ V}$ ,  $f = 200\text{ Hz}$ ;  $t_{\text{ON}} = 3.65\text{ ms}$ ;  $t_{\text{OFF}} = 1.25\text{ ms}$ ;  $T_{\text{R}} = T_{\text{F}} = 10\text{ }\mu\text{s}$ , pulse signal.

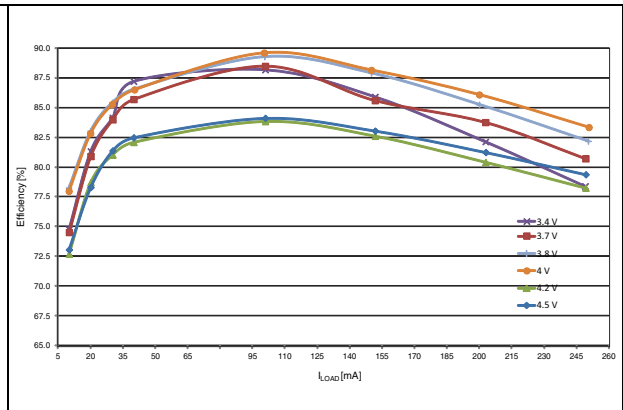
# 5 Typical performance characteristics

$V_{INA} = V_{INP} = 3.7\text{ V}$ ,  $V_{O2} = -4.9\text{ V}$ ,  $T_J = 25\text{ }^\circ\text{C}$ ; see [Table 1](#) for external components used in the tests below.

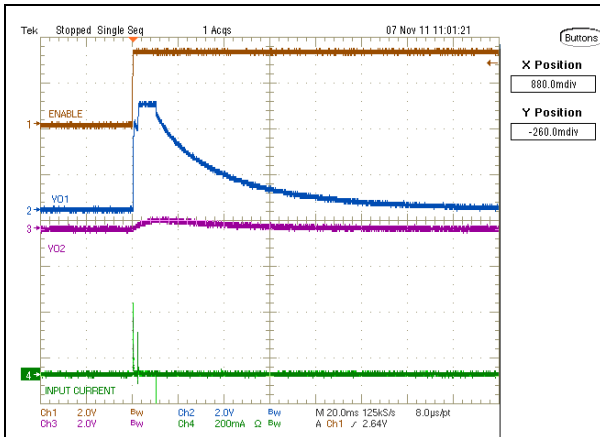
**Figure 4. Maximum power output vs. input voltage**



**Figure 5. Efficiency vs. output current**

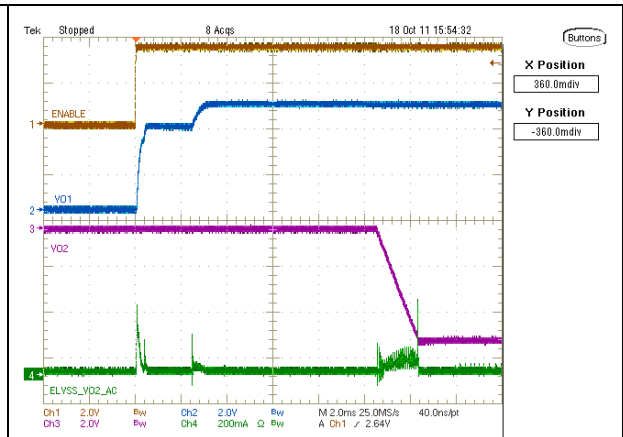


**Figure 6. Soft-start with SSD**



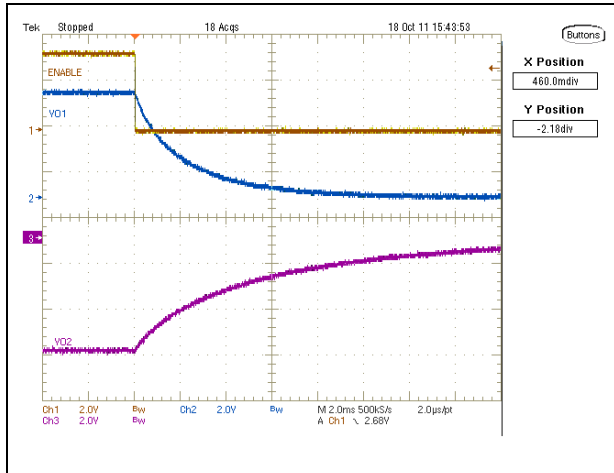
$V_{INA} = V_{INP} = 3.7\text{ V}$ ,  $R_{MID,O2} < 4\text{ k}\Omega$ ,  $L1 = L2$

**Figure 7. Soft-start and inrush current**

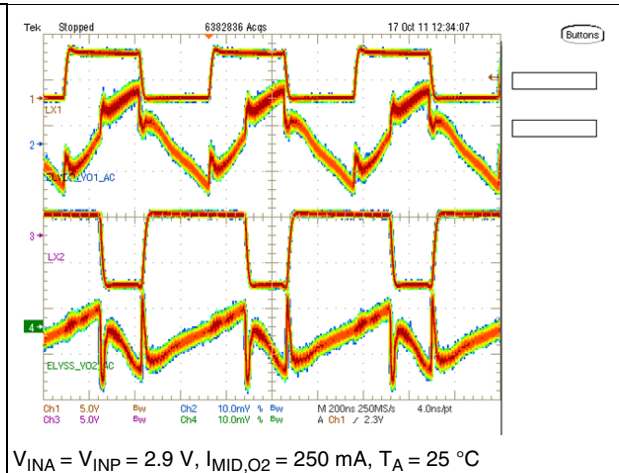


No load

**Figure 8. Fast discharge no load, EN=SW=FD=Low**

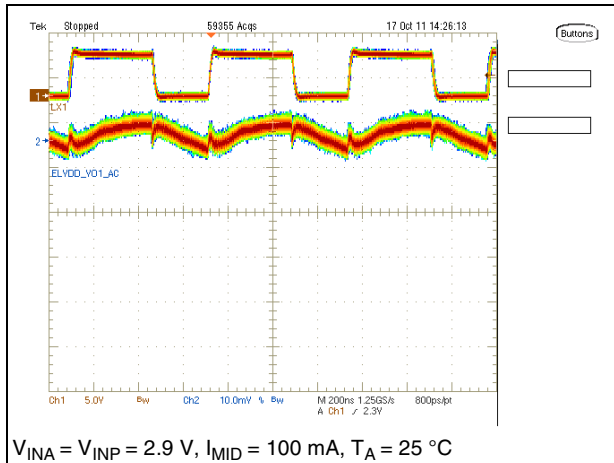


**Figure 9. Switching and output waveforms**



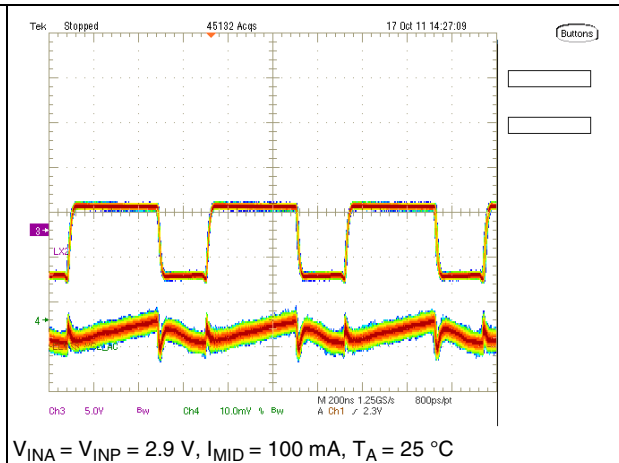
$V_{INA} = V_{INP} = 2.9\text{ V}$ ,  $I_{MID,O2} = 250\text{ mA}$ ,  $T_A = 25\text{ }^\circ\text{C}$

**Figure 10. Step-up CCM operation**



$V_{INA} = V_{INP} = 2.9\text{ V}$ ,  $I_{MID} = 100\text{ mA}$ ,  $T_A = 25\text{ }^\circ\text{C}$

**Figure 11. Inverting CCM operation**



$V_{INA} = V_{INP} = 2.9\text{ V}$ ,  $I_{MID} = 100\text{ mA}$ ,  $T_A = 25\text{ }^\circ\text{C}$

## 6 Detailed description

### 6.1 SWIRE

- Protocol: to digitally communicate over a single cable with single-wire components
- 3 components of the single-wire:
  1. an external MCU
  2. wiring and associated connectors
  3. the STOD13AM device with a dedicated single-wire pin.

#### 6.1.1 SWIRE features and benefits

- Fully digital signal
- No handshake needed
- Protection against glitches and spikes through an internal low pass filter acting on falling edges
- Uses a single wire (plus analog ground) to accomplish both communication and power control transmission
- Simplifies design with an interface protocol that supplies control and signaling over a single-wire connection to set the output voltages.

#### 6.1.2 SWIRE protocol

- Single-wire protocol uses conventional CMOS/TTL logic levels (maximum 0.6 V for logic “zero” and a minimum 1.2 V for logic “one”) with operation specified over a supply voltage range of 2.5 V to 4.5 V
- Both master (MCU) and slave (STOD13AM) are configured to permit bit sequential data to flow only in one direction at a time; master initiates and controls the device
- Data is bit-sequential with a START bit and a STOP bit
- Signal is transferred in real-time
- System clock is not required; each single-wire pulse is self-clocked by the oscillator integrated in the master and is asserted valid within a frequency range of 250 kHz (maximum).

#### 6.1.3 SWIRE basic operations

- The negative output voltage levels are selectable within a wide range (steps of 100 mV)
- The device can be enabled / disabled via  $S_{\text{WIRE}}$  in combination with the Enable pin.

## 6.2 Negative output voltage levels

Table 7. Negative output voltage levels

Pulse	V <sub>O2</sub>	Pulse	V <sub>O2</sub>	Pulse	V <sub>O2</sub>
1	-5.4	11	-4.4	21	-3.4
2	-5.3	12	-4.3	22	-3.3
3	-5.2	13	-4.2	23	-3.2
4	-5.1	14	-4.1	24	-3.1
5	-5.0	15	-4.0	25	-3.0
6 <sup>(1)</sup>	-4.9	16	-3.9	26	-2.9
7	-4.8	17	-3.8	27	-2.8
8	-4.7	18	-3.7	28	-2.7
9	-4.6	19	-3.6	29	-2.6
10	-4.5	20	-3.5	30	-2.5
				31	-2.4

1. Default value.

## 6.3 Enable, SWIRE and FD

Table 8. Enable and SWIRE operation table <sup>(1)</sup>

Enable	SWIRE	Action
Low	Low	Device off
Low	High	Negative output set by S <sub>WIRE</sub>
High	Low	Default negative output voltage
High	High	Default negative output voltage

1. The Enable pin must be set to AGND while using the S<sub>WIRE</sub> function.

Table 9. Fast discharge operation table

FD pin	Action
Low	Fast discharge active after IC shutdown
High	No fast discharge function

*Note:* FD function is only controlled by the FD pin. It is not related to enable block.

## 7 Application information

### 7.1 External passive components

#### 7.1.1 Inductor selection

Magnetic shielded low ESR power inductors must be chosen as the key passive components for switching converters.

For the step-up converter an inductance between 4.7  $\mu\text{H}$  and 6.8  $\mu\text{H}$  is recommended.

For the inverting stage the suggested inductance ranges from 3.3  $\mu\text{H}$  to 4.7  $\mu\text{H}$ .

It is very important to select the right inductor according to the maximum current the inductor can handle to avoid saturation. The step-up and the inverting peak current can be calculated as follows:

##### Equation 1

$$I_{\text{PEAK-BOOST}} = \frac{V_{\text{MID}} \times I_{\text{OUT}}}{\eta_1 \times V_{\text{IN}_{\text{MIN}}}} + \frac{V_{\text{IN}_{\text{MIN}}} \times (V_{\text{MID}} - V_{\text{IN}_{\text{MIN}}})}{2 \times V_{\text{MID}} \times f_s \times L_1}$$

##### Equation 2

$$I_{\text{PEAK-INVERTING}} = \frac{(V_{\text{IN}_{\text{MIN}}} - V_{\text{O2}_{\text{MIN}}}) \times I_{\text{OUT}}}{\eta_2 \times V_{\text{IN}_{\text{MIN}}}} + \frac{V_{\text{IN}_{\text{MIN}}} \times V_{\text{O2}_{\text{MIN}}}}{2 \times (V_{\text{O2}_{\text{MIN}}} - V_{\text{IN}_{\text{MIN}}}) \times f_s \times L_2}$$

where

$V_{\text{MID}}$ : step-up output voltage, fixed at 4.6 V;

$V_{\text{O2}}$ : inverting output voltage including sign (minimum value is the absolute maximum value);

$I_{\text{O}}$ : output current for both DC-DC converters;

$V_{\text{IN}}$ : input voltage of the STOD13AM;

$f_s$ : switching frequency. Use the minimum value of 1.35 MHz for the worst case;

$\eta_1$ : efficiency of step-up converter. Typical value is 0.70;

$\eta_2$ : efficiency of inverting converter. Typical value is 0.60.

The negative output voltage can be set via  $S_{\text{WIRE}}$  at -5.4 V. Accordingly, the inductor peak current, at the maximum load condition, increases. A proper inductor, with a saturation current as a minimum of 1 A, is preferred.

#### 7.1.2 Input and output capacitor selection

It is recommended to use X5R or X7R low ESR ceramic capacitors as input and output capacitors in order to filter any disturbance present in the input line and to obtain stable operation for the two switching converters. A minimum real capacitance value of 6  $\mu\text{F}$  must be guaranteed for  $C_{\text{O2}}$  in all conditions. Considering tolerance, temperature variation and DC polarization, 2 x 10  $\mu\text{F}$  10 V  $\pm$  10% as  $C_{\text{O2}}$  can be used to achieve the required 6  $\mu\text{F}$ .

## 7.2 Recommended PCB layout

The STOD13AM is a high frequency power switching device and therefore requires a proper PCB layout in order to obtain the necessary stability and optimize line/load regulation and output voltage ripple.

Analog input ( $V_{INA}$ ) and power input ( $V_{INP}$ ) must be kept separated and connected together at the  $C_{IN}$  pad only. The input capacitor must be as close as possible to the IC.

In order to minimize the ground noise, a common ground node for power ground and a different one for analog ground must be used. In the recommended layout, the AGND node is placed close to  $C_{REF}$  ground while the PGND node is centered at  $C_{IN}$  ground. They are connected by a separated layer routing on the bottom through vias.

The exposed pad is connected to AGND through vias.

Figure 12. Top layer and silk-screen (top view, not to scale)

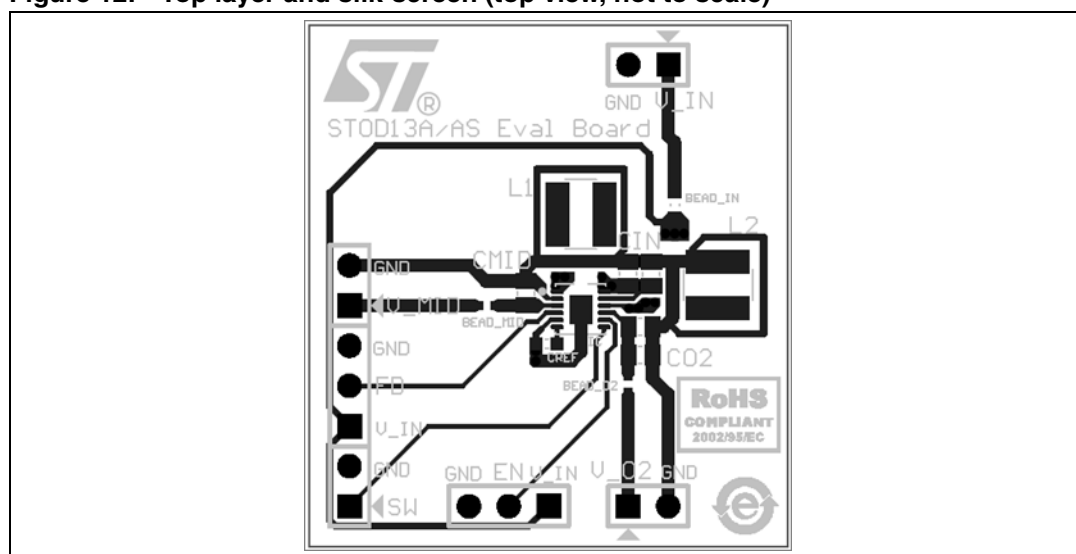
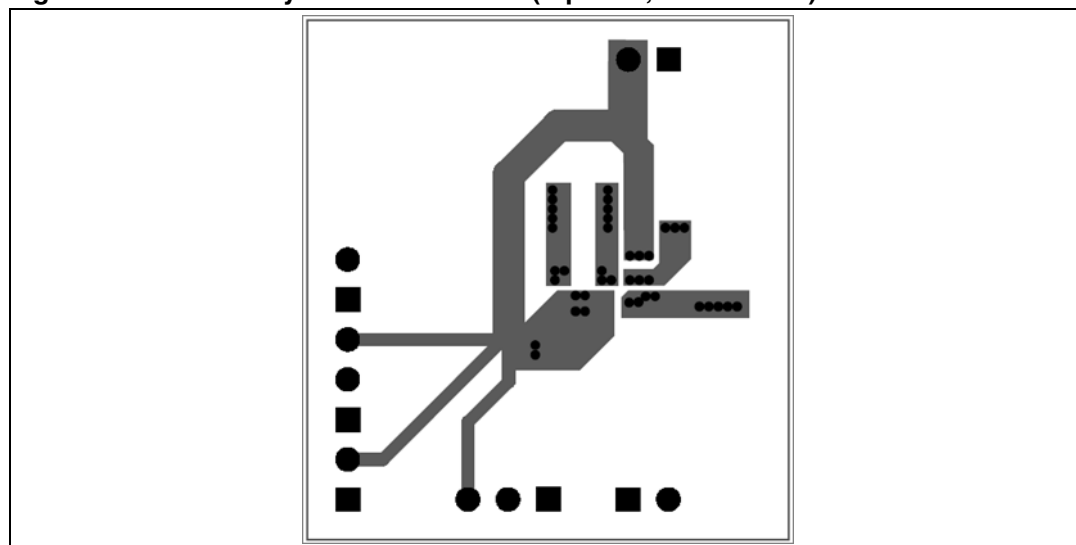


Figure 13. Bottom layer and silk-screen (top view, not to scale)



## 8 Detailed description

### 8.1 General description

The STOD13AM is a high efficiency dual DC-DC converter which integrates a step-up and inverting power stage suitable for supplying AMOLED panels. Thanks to the high level of integration it needs only 6 external components to operate and it achieves very high efficiency using a synchronous rectification technique for each of the two DC-DC converters.

The controller uses an average current mode technique in order to obtain good stability and precise voltage regulation in all possible conditions of input voltage, output voltage, and output current. In addition, the peak inductor current is monitored in order to avoid saturation of the coils.

The STOD13AM implements a power saving technique in order to maintain high efficiency at very light load and it switches to PWM operation as the load increases in order to guarantee the best dynamic performance and low noise operation.

The STOD13AM avoids battery leakage thanks to the true-shutdown feature and it is self protected from overtemperature. Undervoltage lockout and soft-start guarantee proper operation during startup.

#### 8.1.1 Multiple operation modes

Both the step-up and the inverting stage of the STOD13AM operate in three different modes: pulse-skipping (PSM), discontinuous conduction mode (DCM) and continuous conduction mode (CCM). It switches automatically between the three modes according to input voltage, output current, and output voltage conditions.

#### 8.1.2 Pulse-skipping operation

The STOD13AM works in pulse-skipping mode when the load current is below a few mA. The load current level at which this way of operation occurs depends on input voltage only for the step-up converter and on input voltage and negative output voltage ( $V_{O2}$ ) for the inverting converter.

#### 8.1.3 Discontinuous conduction mode

When the load increases above a few mA, the STOD13AM enters DCM operation. In order to obtain this type of operation the controller must avoid the inductor current going negative. The discontinuous mode detector (DMD) blocks sense the voltage across the synchronous rectifiers (P1B for the step-up and N2 for the inverting) and turn off the switches when the voltage crosses a defined threshold which, in turn, represents a certain current in the inductor. This current can vary according to the slope of the inductor current which depends on input voltage, inductance value, and output voltage.

#### 8.1.4 Continuous conduction mode

At medium/high output loads, the STOD13AM enters full CCM at constant switching frequency mode for each of the two DC-DC converters.

### 8.1.5 Enable pin

The device operates when the EN pin is set high. If the EN pin is set low, the device stops switching, and all the internal blocks are turned off. In this condition the current drawn from  $V_{INP}/V_{INA}$  is below 1  $\mu$ A in the whole temperature range. In addition, the internal switches are in an OFF state so the load is electrically disconnected from the input; this avoids unwanted current leakage from the input to the load.

### 8.1.6 Soft-start and inrush current limiting

After the EN pin is pulled high, or after a suitable voltage is applied to  $V_{INP}$ ,  $V_{INA}$  and EN, the device initiates the start-up phase.

As a first step, the  $C_{MID}$  capacitor is charged and the P1B switch implements a current limiting technique in order to keep the charge current below 400 mA. This avoids the battery overloading during startup.

After  $V_{MID}$  reaches the  $V_{INP}$  voltage level, the P1B switch is fully turned on and the soft-start procedure for the step-up is started. After around 2 ms the soft-start for the inverting is started. The positive and negative voltages are under regulation at around 13 ms after the EN pin is asserted high.

### 8.1.7 Undervoltage lockout

The undervoltage lockout function avoids improper operation of the STOD13AM when the input voltage is not high enough. When the input voltage is below the UVLO threshold the device is in shutdown mode. The hysteresis of 50 mV avoids unstable operation when the input voltage is close to the UVLO threshold.

### 8.1.8 Overtemperature protection

An internal temperature sensor continuously monitors the IC junction temperature. If the IC temperature exceeds 140 °C, typical, the device stops operating. As soon as the temperature falls below 125 °C, typical, normal operation is restored.

### 8.1.9 Short-circuit protection during soft-start (SSD)

During device soft-start on the positive output, an internal comparator checks if the panel is damaged. In this case, soft-start is stopped and the device is parked in power-off. To reset the normal functionality (assuming that the anomalous load condition is removed), it is necessary to restart the converter through an enable transient.

If the panel is not damaged it is possible to proceed with the soft-start of the negative output and both reach their final value, therefore ensuring normal output voltages and functionality.

### 8.1.10 Overload protection (OLP)

The output current is internally limited. An overload condition, as a short-circuit between the two outputs or between each output and GND, produces the device power-off. To reset the normal functionality (assuming that the short condition is removed), it is necessary to restart the converter through an enable transient.

### 8.1.11 Short-circuit protection (SCP)

When short-circuit occurs, the device is able to detect the voltage difference between  $V_{IN}$  and  $V_{OUT}$ . Overshoots are limited, decreasing the inductor current. After that, the output stages of the device are turned off. This status is maintained, avoiding current flowing to the load. A new ENABLE transition is needed to restart the device. During startup the short-circuit protection is active.

### 8.1.12 Fast discharge

When ENABLE turns from high to low level, the device goes into shutdown mode and LX1 and LX2 stop switching. If the FD pin is low, a resistor of about 400  $\Omega$  is connected between  $V_{MID}$  and  $V_{O2}$  to discharge quickly  $C_{MID}$  and  $C_{O2}$  capacitors, lowering by about 10 ms the differential output voltage ( $V_{MID}-V_{O2}$ ) below 10% of nominal value. When the output voltages are discharged to 0 V, the switches turn off and the outputs are high impedance. When the FD pin is high, the fast discharge after shutdown is off.

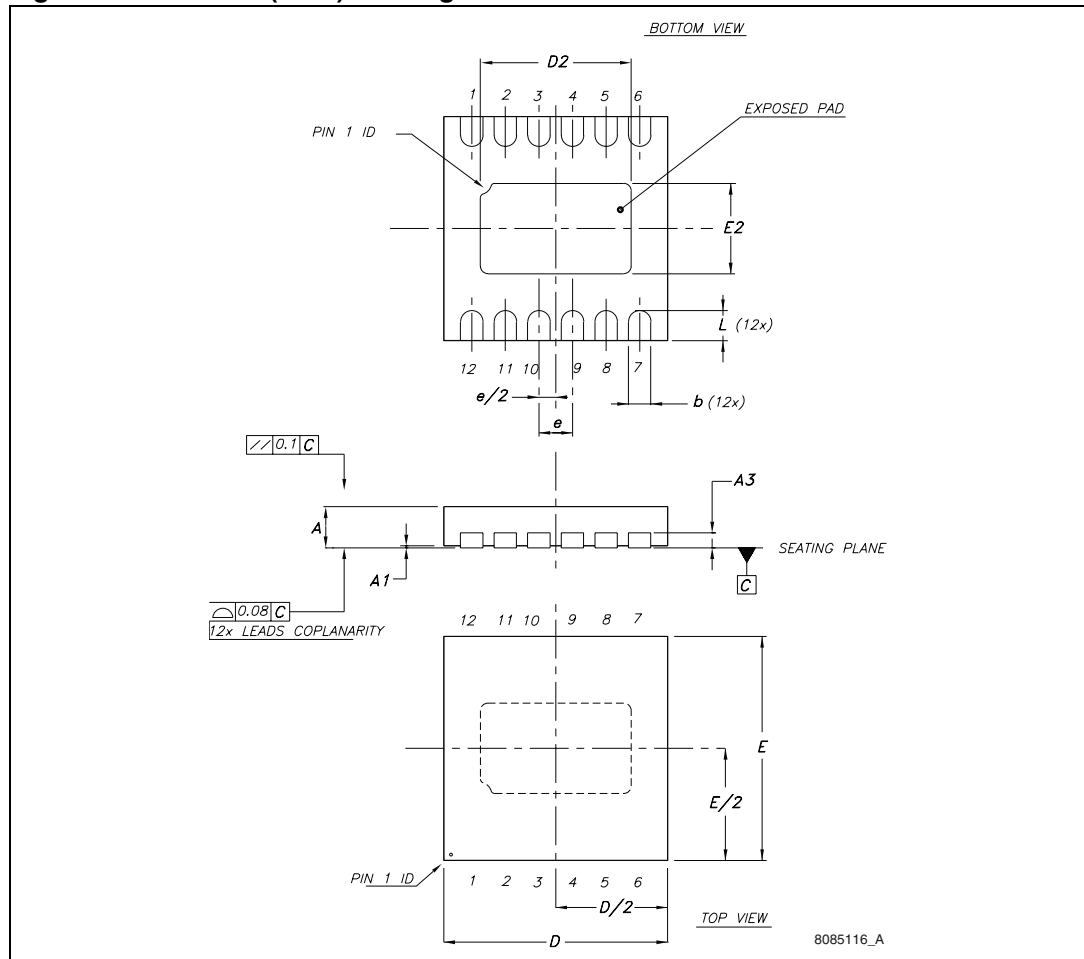
## 9 Package mechanical data

In order to meet environmental requirements, ST offers these devices in different grades of ECOPACK<sup>®</sup> packages, depending on their level of environmental compliance. ECOPACK specifications, grade definitions and product status are available at: [www.st.com](http://www.st.com). ECOPACK is an ST trademark.

Table 10. DFN12L (3 x 3) mechanical data

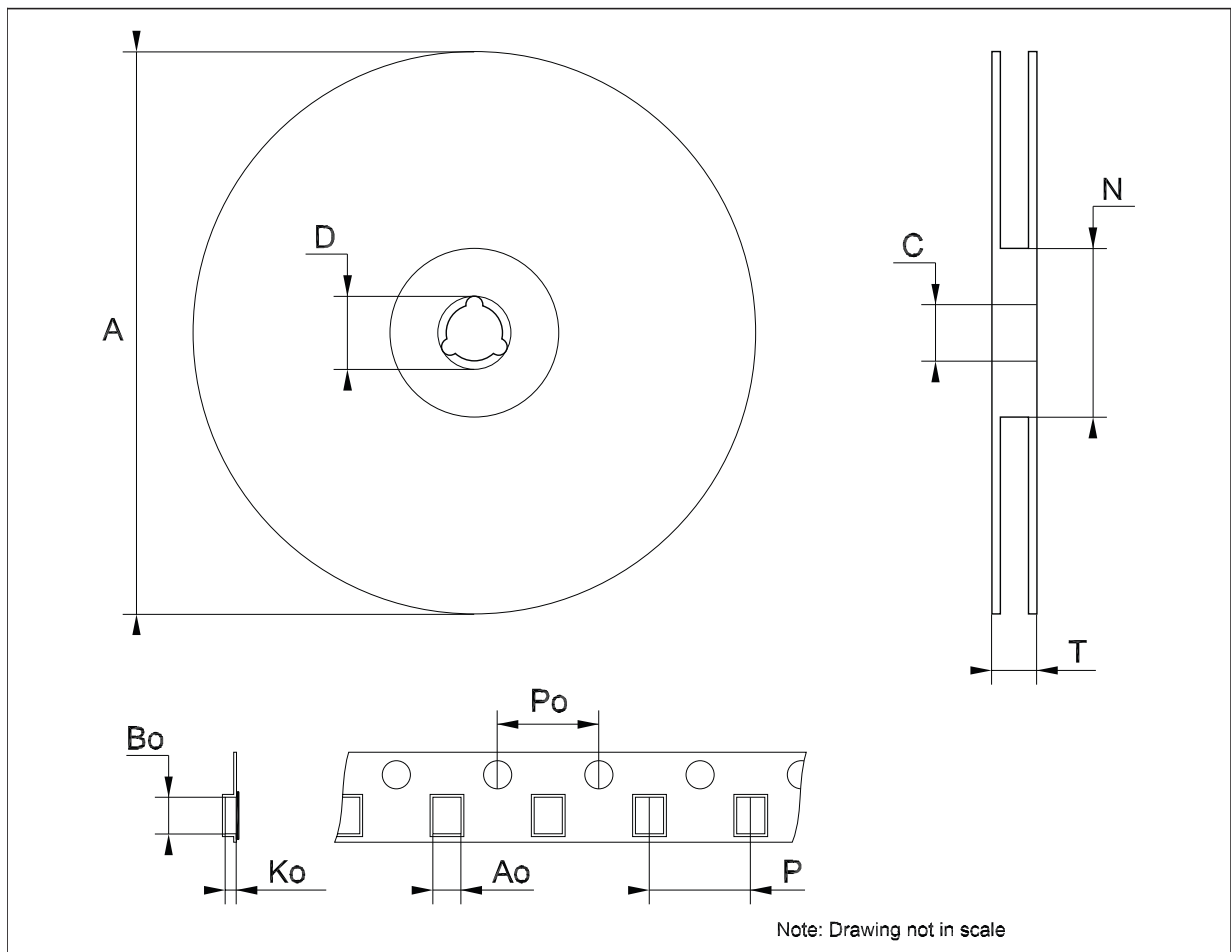
Dim.	mm			inch		
	Min.	Typ.	Max.	Min.	Typ.	Typ.
A	0.51	0.55	0.60	0.020	0.022	0.024
A1	0	0.02	0.05	0	0.001	0.002
A3		0.20			0.008	
b	0.18	0.25	0.30	0.007	0.010	0.012
D	2.85	3	3.15	0.112	0.118	0.124
D2	1.87	2.02	2.12	0.074	0.080	0.083
E	2.85	3	3.15	0.112	0.118	0.124
E2	1.06	1.21	1.31	0.042	0.048	0.052
e		0.45			0.018	
L	0.30	0.40	0.50	0.012	0.016	0.020

Figure 14. DFN12L (3 x 3) drawing



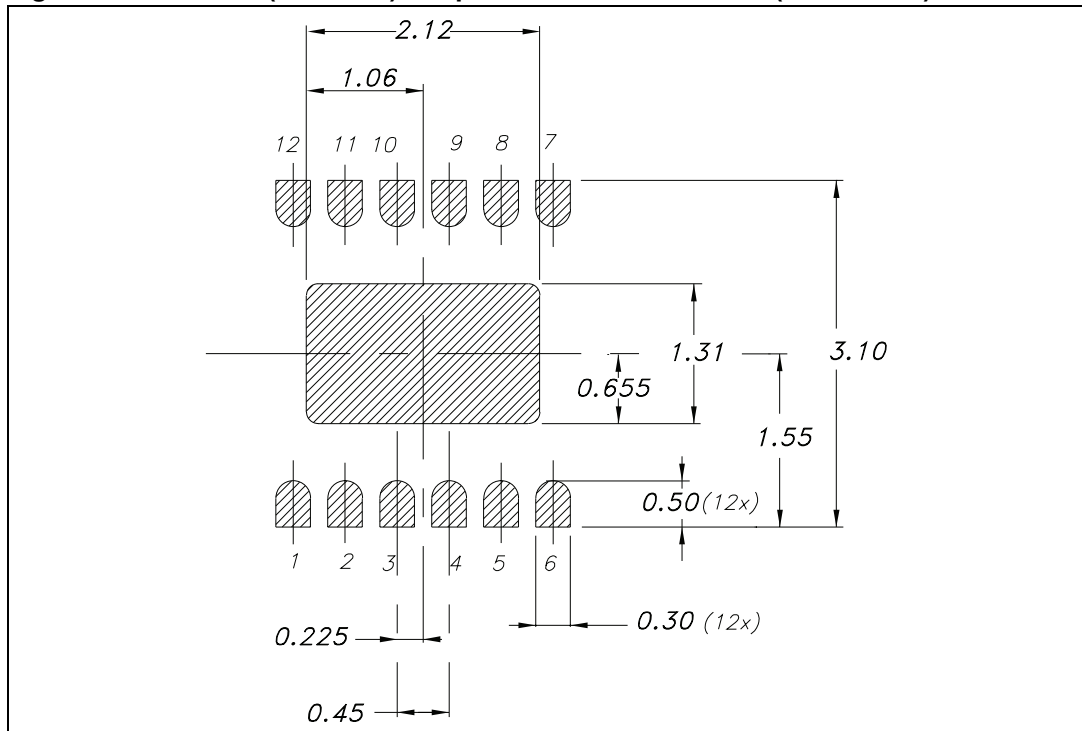
**Tape & reel QFNxx/DFNxx (3x3) mechanical data**

DIM.	mm.			inch		
	MIN.	TYP	MAX.	MIN.	TYP.	MAX.
A			330			12.992
C	12.8		13.2	0.504		0.519
D	20.2			0.795		
N	99		101	3.898		3.976
T			14.4			0.567
Ao		3.3			0.130	
Bo		3.3			0.130	
Ko		1.1			0.043	
Po		4			0.157	
P		8			0.315	



Note: Drawing not in scale

Figure 15. DFN12L (3 x 3 mm) footprint recommended data (millimeters)



## 10 Revision history

**Table 11. Document revision history**

Date	Revision	Changes
02-Oct-2012	1	Initial release.

**Please Read Carefully:**

Information in this document is provided solely in connection with ST products. STMicroelectronics NV and its subsidiaries ("ST") reserve the right to make changes, corrections, modifications or improvements, to this document, and the products and services described herein at any time, without notice.

All ST products are sold pursuant to ST's terms and conditions of sale.

Purchasers are solely responsible for the choice, selection and use of the ST products and services described herein, and ST assumes no liability whatsoever relating to the choice, selection or use of the ST products and services described herein.

No license, express or implied, by estoppel or otherwise, to any intellectual property rights is granted under this document. If any part of this document refers to any third party products or services it shall not be deemed a license grant by ST for the use of such third party products or services, or any intellectual property contained therein or considered as a warranty covering the use in any manner whatsoever of such third party products or services or any intellectual property contained therein.

**UNLESS OTHERWISE SET FORTH IN ST'S TERMS AND CONDITIONS OF SALE ST DISCLAIMS ANY EXPRESS OR IMPLIED WARRANTY WITH RESPECT TO THE USE AND/OR SALE OF ST PRODUCTS INCLUDING WITHOUT LIMITATION IMPLIED WARRANTIES OF MERCHANTABILITY, FITNESS FOR A PARTICULAR PURPOSE (AND THEIR EQUIVALENTS UNDER THE LAWS OF ANY JURISDICTION), OR INFRINGEMENT OF ANY PATENT, COPYRIGHT OR OTHER INTELLECTUAL PROPERTY RIGHT.**

**UNLESS EXPRESSLY APPROVED IN WRITING BY TWO AUTHORIZED ST REPRESENTATIVES, ST PRODUCTS ARE NOT RECOMMENDED, AUTHORIZED OR WARRANTED FOR USE IN MILITARY, AIR CRAFT, SPACE, LIFE SAVING, OR LIFE SUSTAINING APPLICATIONS, NOR IN PRODUCTS OR SYSTEMS WHERE FAILURE OR MALFUNCTION MAY RESULT IN PERSONAL INJURY, DEATH, OR SEVERE PROPERTY OR ENVIRONMENTAL DAMAGE. ST PRODUCTS WHICH ARE NOT SPECIFIED AS "AUTOMOTIVE GRADE" MAY ONLY BE USED IN AUTOMOTIVE APPLICATIONS AT USER'S OWN RISK.**

Resale of ST products with provisions different from the statements and/or technical features set forth in this document shall immediately void any warranty granted by ST for the ST product or service described herein and shall not create or extend in any manner whatsoever, any liability of ST.

ST and the ST logo are trademarks or registered trademarks of ST in various countries.

Information in this document supersedes and replaces all information previously supplied.

The ST logo is a registered trademark of STMicroelectronics. All other names are the property of their respective owners.

© 2012 STMicroelectronics - All rights reserved

STMicroelectronics group of companies



Australia - Belgium - Brazil - Canada - China - Czech Republic - Finland - France - Germany - Hong Kong - India - Israel - Italy - Japan - Malaysia - Malta - Morocco - Philippines - Singapore - Spain - Sweden - Switzerland - United Kingdom - United States of America

[www.st.com](http://www.st.com)



## Looking for pricing, stock, or lifecycle information?

Click below to explore more details on WIN SOURCE:

-  [View STOD13AMTPUR on WIN SOURCE](#)
-  [STMicroelectronics Information](#)

## Optimize Your Supply Chain with WIN SOURCE Solutions

-  Global Sourcing Solution
-  Obsolete Management
-  Cost Control Management
-  Shortage Management
-  Alternative Solution
-  Excess Inventory Management