

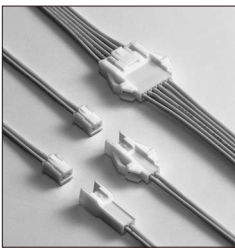

THE DATASHEET OF XARR-07V





XA CONNECTOR

2.5mm pitch/Disconnectable Crimp style wire-to-wire connectors

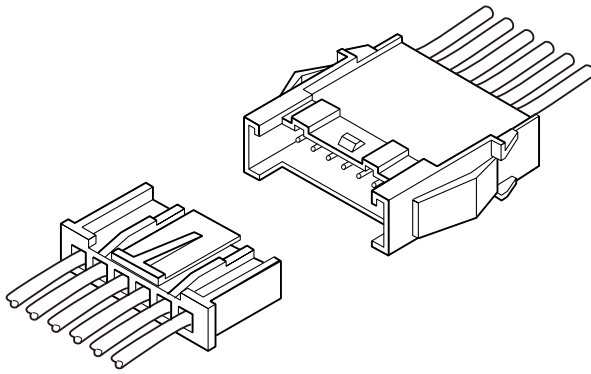

2.5mm pitch wire-to-wire connector that can mate with the socket of XA connector (board-to-wire type). Reliable secondary retainer is available. Panel mount is applicable.

- Possible to mate with the existing XA socket
- Inner type contact lance
- Mountable on a variety of panels
- Secondary retainer
- Secure lock construction

Specifications

- Current rating: 3A AC, DC max. (AWG #20)
- Voltage rating: 250V AC, DC max.
- Temperature range: -25°C to +85°C
(including temperature rise in applying electrical current)
- Contact resistance: Initial value/10m Ω max.
After environmental testing/20m Ω max.
- Insulation resistance: 500M Ω min.
- Withstanding voltage: 1,500V AC/minute
- Applicable wire: AWG #28 to #20
- * Compliant with RoHS.
- * Refer to "General Instruction and Notice when using Terminals and Connectors" at the end of this catalog.
- * Contact JST for details.

Standards

- Recognized E60389
- Certified LR20812
- R9851220

Panel layout and Assembly layout

Without panel locks

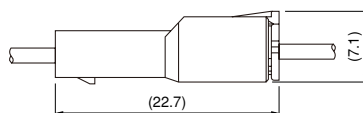

With panel locks

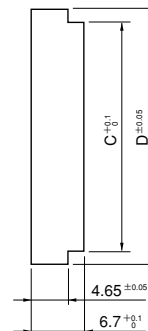
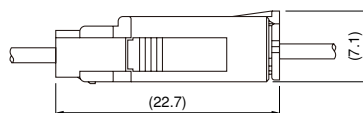

Note: C and D dimensions: Refer to receptacle housing.

XA CONNECTOR

Contact

Pin contact

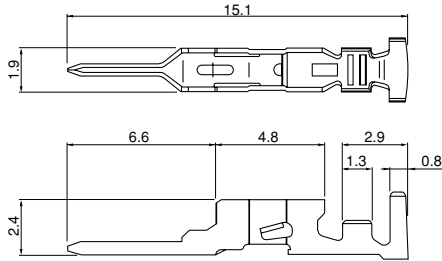

Socket contact

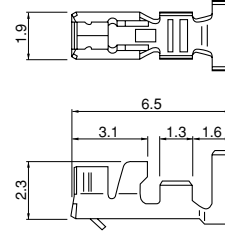

Model No.		Applicable wire		Insulation O.D.(mm)	Q'ty / reel	
Pin contact	Socket contact	mm ²	AWG #		Pin contact	Socket contact
SXAM-001T-P0.6	SXA-001T-P0.6	0.08~0.33	28~22	0.8~1.9	7,000	8,000
SXAM-01T-P0.6	SXA-01T-P0.6	0.22~0.5	24~20	1.5~1.9	7,000	8,000

Material and Finish

Phosphor bronze, tin-plated (reflow treatment)

RoHS compliance

Note: Contact JST for gold-plated products.

Contact	Crimping machine	Applicator		
		Crimp applicator	Dies	Crimp applicator with dies
SXA-001T-P0.6	AP-K2N	MKS-L	MK/SXAM/XA-001-06	APLMK SXAM/XA001-06
		*MKS-SC	SC/SXAM/XA-001-06	APLSC SXAM/XA001-06
SXA-01T-P0.6		MKS-L	MK/SXAM/XA-01-06	APLMK SXAM/XA01-06
		*MKS-SC	SC/SXAM/XA-01-06	APLSC SXAM/XA01-06

Note: *Strip-crimp applicator

Contact	Crimping machine	Applicator		
		Crimp applicator	Dies	Crimp applicator with dies
SXAM-001T-P0.6	AP-K2N	MKS-L	MK/SXAM/XA-001-06	APLMK SXAM/XA001-06
		*MKS-SC	SC/SXAM/XA-001-06	APLSC SXAM/XA001-06
SXAM-01T-P0.6		MKS-L	MK/SXAM/XA-01-06	APLMK SXAM/XA01-06
		*MKS-SC	SC/SXAM/XA-01-06	APLSC SXAM/XA01-06

Receptacle housing (for pin dies contact)

Without panel locks

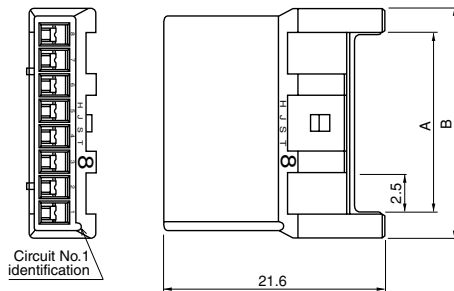

With panel locks

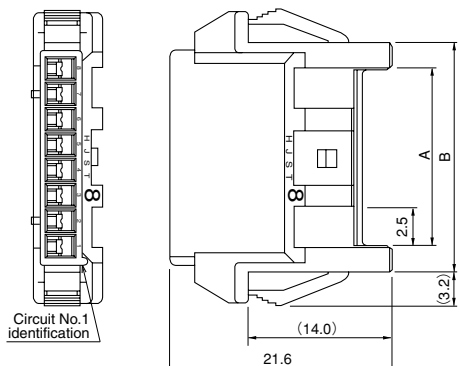

Circuits	Model No.		Dimensions (mm)				Q'ty / bag
	Without panel locks	With panel locks	A	B	C	D	
2	XARR-02VF	XARR-02V	2.5	7.5	7.9	11.2	1,000
3	XARR-03VF	XARR-03V	5.0	10.0	10.4	13.7	1,000
4	XARR-04VF	XARR-04V	7.5	12.5	12.9	16.2	1,000
5	XARR-05VF	XARR-05V	10.0	15.0	15.4	18.7	1,000
6	XARR-06VF	XARR-06V	12.5	17.5	17.9	21.2	500
7	—	XARR-07V	15.0	20.0	20.4	23.7	500
8	XARR-08VF	XARR-08V	17.5	22.5	22.9	26.2	500
9	XARR-09VF	XARR-09V	20.0	25.0	25.4	28.7	500
10	XARR-10VF	XARR-10V	22.5	27.5	27.9	31.2	500
11	—	XARR-11V	25.0	30.0	30.4	33.7	500
12	XARR-12VF	XARR-12V	27.5	32.5	32.9	36.2	500
13	—	XARR-13V	30.0	35.0	35.4	38.7	500
14	—	XARR-14V	32.5	37.5	37.9	41.2	500
15	—	XARR-15V	35.0	40.0	40.4	43.7	500

Material

PA 66, UL94V-0, natural (white)

RoHS compliance

Note: C and D dimensions: Panel layout dimensions

XA CONNECTOR

Plug housing (for socket contact)

Standard type

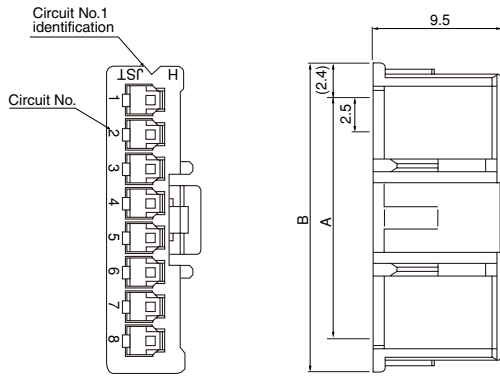

Retainer mountable type

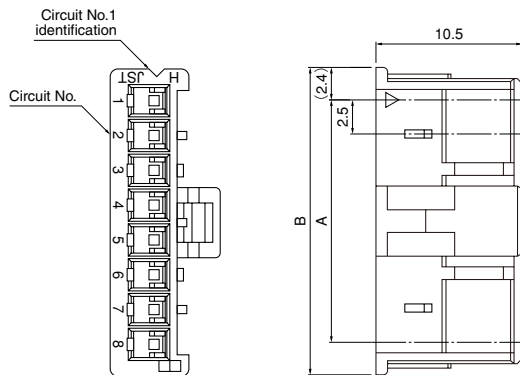

Circuits	Model No.		Dimensions (mm)		Q'ty / bag	
	Standard type	Retainer mountable type	A	B	Standard type	Retainer mountable type
2	XAP-02V-1	XARP-02V	2.5	7.3	1,000	1,000
3	XAP-03V-1	XARP-03V	5.0	9.8	1,000	1,000
4	XAP-04V-1	XARP-04V	7.5	12.3	1,000	1,000
5	XAP-05V-1	XARP-05V	10.0	14.8	1,000	1,000
6	XAP-06V-1	XARP-06V	12.5	17.3	1,000	1,000
7	XAP-07V-1	XARP-07V	15.0	19.8	1,000	1,000
8	XAP-08V-1	XARP-08V	17.5	22.3	1,000	1,000
9	XAP-09V-1	XARP-09V	20.0	24.8	1,000	1,000
10	XAP-10V-1	XARP-10V	22.5	27.3	1,000	1,000
11	XAP-11V-1	XARP-11V	25.0	29.8	1,000	1,000
12	XAP-12V-1	XARP-12V	27.5	32.3	1,000	1,000
13	XAP-13V-1	XARP-13V	30.0	34.8	1,000	1,000
14	XAP-14V-1	XARP-14V	32.5	37.3	500	1,000
15	XAP-15V-1	XARP-15V	35.0	39.8	500	1,000

Material

PA 66, UL94V-0, natural (white)

RoHS compliance

Retainer

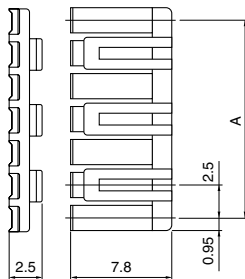

Circuits	Model No.	A	Q'ty / bag
2	XMS-02V	2.5	1,000
3	XMS-03V	5.0	1,000
4	XMS-04V	7.5	1,000
5	XMS-05V	10.0	1,000
6	XMS-06V	12.5	1,000
7	XMS-07V	15.0	1,000
8	XMS-08V	17.5	1,000
9	XMS-09V	20.0	1,000
10	XMS-10V	22.5	1,000
11	XMS-11V	25.0	1,000
12	XMS-12V	27.5	1,000
13	XMS-13V	30.0	1,000
14	XMS-14V	32.5	1,000
15	XMS-15V	35.0	1,000



Material

Glass-filled PA 66, UL94V-0, natural (ivory)

RoHS compliance

Looking for pricing, stock, or lifecycle information?

Click below to explore more details on WIN SOURCE:

-  [View XARR-07V on WIN SOURCE](#)
-  [JST Sales America Inc. Information](#)

Optimize Your Supply Chain with WIN SOURCE Solutions

-  Global Sourcing Solution
-  Obsolete Management
-  Cost Control Management
-  Shortage Management
-  Alternative Solution
-  Excess Inventory Management