



**THE DATASHEET OF
XC6222A151PR-G**



700mA High Speed LDO Regulator with Reverse Current Protection

■ GENERAL DESCRIPTION

The XC6222 series is a highly accurate, low noise, high ripple rejection, low dropout, and low power consumption high speed CMOS voltage regulator. The series consists of a voltage reference, an error amplifier, a driver transistor, a current limiter, a thermal protection circuit, a reverse current protection circuit and a phase compensation circuit.

The CE function enables the entire circuit to be placed in a stand-by state by inputting a low level signal to the CE pin. In this stand-by mode, the electric charge at the output capacitor (C_L) will be discharged by the internal auto-discharge switch, and as a result the V_{OUT} pin will quickly return to the V_{SS} level.

Over-current protection and thermal protection circuits are integrated. The protection circuit starts to operate when either output current reaches the current limit level or junction temperature reaches the temperature limit. With the reverse current protection function, the reverse current flow is prohibited when V_{OUT} voltage is higher than V_{IN} voltage. The protection diode of IC is not necessary.

■ APPLICATIONS

- USB Products
- CD/DVD/HDD drives
- Mobile phones
- Portable game consoles
- Camera modules
- Electronic dictionaries

■ FEATURES

| | |
|---------------------------------|--|
| Maximum Output Current | : 700mA |
| Dropout Voltage | : 120mV @ $I_{OUT}=300\text{mA}$ ($V_{OUT}=3.0\text{V}$) |
| Operating Voltage Range | : 1.7V ~ 6.0V |
| Output Voltages | : 0.8V~5.0V (0.05V increments) |
| Accuracy | : $\pm 1\%$ ($V_{OUT} > 2.0\text{V}$) $\pm 0.02\text{V}$ ($V_{OUT} \leq 2.0\text{V}$) |
| Low Power Consumption | : 100 μA ($V_{OUT}=3.0\text{V}$) |
| High Ripple Rejection | : 65dB @ 1kHz |
| Operating Temperature | : $-40^\circ\text{C} \sim +85^\circ\text{C}$ |
| Low ESR Capacitor | : Ceramic capacitor |
| Chip Enable(CE) | : Active High, C_L discharge Standby Current below 0.1 μA |
| Packages | : USP-6C, SOT-25, SOT-89-5 |
| Environmentally Friendly | : EU RoHS Compliant, Pb Free |

■ TYPICAL APPLICATION CIRCUIT



SOT-25
(TOP VIEW)

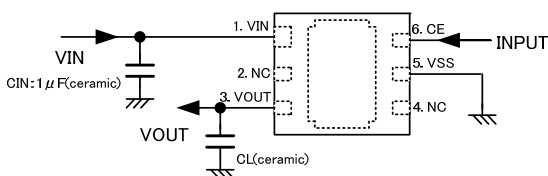

USP-6C
(TOP VIEW)

- * C_L : 2.2 μF or higher ($V_{OUT}=2.5 \sim 5.0\text{V}$)
 4.7 μF or higher ($V_{OUT}=2.1 \sim 2.45\text{V}$)
 6.8 μF or higher ($V_{OUT}=0.8 \sim 2.05\text{V}$)

■ TYPICAL PERFORMANCE CHARACTERISTICS

- Load Transient Response

XC6222x151

$t_r = t_f = 5 \mu\text{s}$, $V_{IN} = 2.5\text{V}$, $T_a = 25^\circ\text{C}$
 $V_{OUT} = 1.0 \rightarrow 300\text{mA}$, $C_{IN} = 1.0 \mu\text{F}$ (ceramic), $C_L = 6.8 \mu\text{F}$ (ceramic)



PIN CONFIGURATION



*The dissipation pad for the USP-6C package should be solder-plated in recommended mount pattern and metal masking so as to enhance mounting strength and heat release. If the pad needs to be connected to other pins, it should be connected to the V_{SS} (No. 5) pin.

PIN ASSIGNMENT

| PIN NUMBER | | | PIN NAME | FUNCTIONS |
|------------|--------|----------|-----------|----------------|
| USP-6C | SOT-25 | SOT-89-5 | | |
| 1 | 1 | 4 | V_{IN} | Power Input |
| 3 | 5 | 5 | V_{OUT} | Output |
| 2,4 | 4 | 3 | NC | No connection |
| 5 | 2 | 2 | V_{SS} | Ground |
| 6 | 3 | 1 | CE | ON/OFF Control |

PRODUCT CLASSIFICATION

Ordering Information

XC6222①②③④⑤⑥-⑦^(*)

| DESIGNATOR | ITEM | SYMBOL | DESCRIPTION |
|---------------------|--------------------------|-----------------------------|---|
| ① | Type of CE | A | without CE Pull-down resistor, without C_L discharge |
| | | B | without CE Pull-down resistor, with C_L discharge |
| | | C | with CE Pull-down resistor, without C_L discharge |
| | | D (The Recommended Type) | with CE Pull-down resistor, with C_L discharge |
| ②③ | Output Voltage | 08~50 | e.g. 2.8V → ②=2, ③=8 Output Voltage Range : 0.8~5.0 V (0.05V increments) |
| ④ | Output Voltage Accuracy | 1 | Output voltage {x.x0v} (the 2 nd decimal place is "0") Accuracy±1% ($V_{OUT}>2.0V$), ±0.02V($V_{OUT}\leq 2.0V$) |
| | | B | Output voltage {x.x5v} (the 2 nd decimal place is "5") Accuracy±1% ($V_{OUT}>2.0V$), ±0.02V($V_{OUT}\leq 2.0V$) |
| ⑤⑥-⑦ ^(*) | Packages (Order Unit) | ER-G | USP-6C (3,000/Reel) |
| | | MR-G | SOT-25 (3,000/Reel) |
| | | PR-G | SOT-89-5 (1,000/Reel) |

^(*) The "-G" suffix indicates that the products are Halogen and Antimony free as well as being fully RoHS compliant.

■ BLOCK DIAGRAMS



XC6222Aseries



XC6222Dseries

* Diodes inside the circuits are ESD protection diodes and parasitic diodes.

■ ABSOLUTE MAXIMUM RATINGS

Ta=25°C

| PARAMETER | | SYMBOL | RATINGS | UNITS |
|-----------------------------|----------|-----------------------------------|-----------------------------------|-------|
| Input Voltage | | V _{IN} | -0.3~+6.5 | V |
| Output Current | | I _{OUT} | 1400 ⁽¹⁾ | mA |
| Output Voltage | | V _{OUT} | V _{SS} -0.3~+6.5 | V |
| CE Input Voltage | | V _{CE} | V _{SS} -0.3~+6.5 | V |
| Power Dissipation | USP-6C | Pd | 120 | mW |
| | | | 1000 (PCB mounted) ⁽²⁾ | |
| | SOT-25 | | 250 | |
| | | | 600 (PCB mounted) ⁽²⁾ | |
| | SOT-89-5 | | 500 | |
| | | 1300 (PCB mounted) ⁽²⁾ | | |
| Operating Temperature Range | | Topr | -40~+85 | °C |
| Storage Temperature Range | | Tstg | -55~+125 | °C |

*1. Please use within the range of Pd > {(V_{IN}-V_{OUT}) × I_{OUT}}

*2. The power dissipation figure shown is PCB mounted. Please refer to page 22 to 24 for details.

ELECTRICAL CHARACTERISTICS

●XC6222 Series

Ta=25°C

| PARAMETER | SYMBOL | CONDITIONS | MIN. | TYP. | MAX. | UNITS | CIRCUIT |
|---|--|--|-------------------------------|------------------------------|-------------------------------|----------|---------|
| Output Voltage | $V_{OUT(E)}$ ^{(*)2} | $V_{OUT(T)} > 2.0V$ $V_{CE}=V_{IN}, I_{OUT}=10mA$ | $\times 0.99$ ^{(*)3} | $V_{OUT(T)}$ ^{(*)4} | $\times 1.01$ ^{(*)3} | V | ① |
| | | $V_{OUT} \leq 2.0V$ $V_{CE}=V_{IN}, I_{OUT}=10mA$ | -0.02 ^{(*)3} | | +0.02 ^{(*)3} | | |
| Output Current | I_{OUTMAX} | $V_{CE}=V_{IN}, V_{IN}=V_{OUT(T)}+1.0V$ $V_{OUT(T)} \geq 1.5V$ | 700 | - | - | mA | ① |
| | | $V_{CE}=V_{IN}, V_{IN}=2.5V$ $V_{OUT(T)} < 1.5V$ | | | | | |
| Load Regulation | ΔV_{OUT} | $V_{CE}=V_{IN}, 0.1mA \leq I_{OUT} \leq 300mA$ | see the Voltage Chart E-1 | | | mV | ① |
| Dropout Voltage ^{(*)5} | V_{dif} | $I_{OUT}=300mA, V_{CE}=V_{IN}$ | see the Voltage Chart E-2 | | | mV | ① |
| Supply Current | I_{SS} | $V_{IN}=V_{CE}=V_{OUT(T)}+1.0V,$ $I_{OUT}=0mA$ | - | 100 | 220 | μA | ② |
| Stand-by Current | I_{STBY} | $V_{IN}=6.0V, V_{CE}=V_{SS}$ | - | 0.01 | 0.1 | μA | ② |
| Line Regulation | $\frac{\Delta V_{OUT}}{(\Delta V_{IN} \cdot V_{OUT})}$ | $V_{OUT(T)}+0.5V \leq V_{IN} \leq 6.0V$: $V_{OUT(T)} \geq 1.0V$ $V_{CE}=V_{IN}, I_{OUT}=30mA$ | - | 0.01 | 0.1 | %V | ① |
| | | $1.5V \leq V_{IN} \leq 6.0V$: $V_{OUT(T)} \leq 0.95V$ $V_{CE}=V_{IN}, I_{OUT}=30mA$ | | | | | |
| Input Voltage | V_{IN} | | 1.7 | - | 6.0 | V | ① |
| Output Voltage Temperature Characteristics | $\frac{\Delta V_{OUT}}{(\Delta Ta \cdot V_{OUT})}$ | $V_{CE}=V_{IN}, I_{OUT}=30mA$ $-40^\circ C \leq Ta \leq 85^\circ C$ | - | ± 100 | - | ppm/°C | ① |
| Ripple Rejection Rate | PSRR | $V_{OUT(T)} \geq 1.0V$ $V_{IN} = \{V_{OUT(T)} + 1.0\} V_{DC} + 0.5V_{p-pAC}$ $V_{CE}=V_{IN}, I_{OUT}=30mA, f=1kHz$ | - | 65 | - | dB | ③ |
| | | $V_{OUT(T)} < 1.0V$ $V_{IN} = 2.0V_{DC} + 0.5V_{p-pAC}$ $V_{CE}=V_{IN}, I_{OUT}=30mA, f=1kHz$ | | | | | |
| Limit Current | I_{LIM} | $V_{CE}=V_{IN}, V_{IN}=V_{OUT(T)}+1.0V$ $V_{OUT(T)} \geq 1.5V$ | 720 | 950 | - | mA | ① |
| | | $V_{CE}=V_{IN}, V_{IN}=2.5V$ $V_{OUT(T)} < 1.5V$ | | | | | |
| Short Current | I_{SHORT} | $V_{CE}=V_{IN}$ Short V_{OUT} to V_{SS} level | - | 55 | - | mA | ① |
| CE High Level Voltage | V_{CEH} | | 1.2 | - | 6.0 | V | ① |
| CE Low Level Voltage | V_{CEL} | | - | - | 0.3 | V | ① |
| CE High Level Current | I_{CEH} | $V_{CE}=V_{IN}=6.0V, XC6222A/B$ series | -0.1 | - | 0.1 | μA | ① |
| | | $V_{CE}=V_{IN}=6.0V, XC6222C/D$ series | 17.7 | 24 | 36.9 | μA | ① |
| CE High Level Voltage | I_{CEL} | $V_{CE}=V_{SS}$ | -0.1 | - | 0.1 | μA | ① |
| Reverse Current | I_{REV} | $V_{IN}=0V, V_{OUT}=V_{OUT(T)}, V_{CE}=V_{IN}$ or V_{SS} | - | 0.01 | 1.5 | μA | ① |
| V_{OUT} Pin Sink Current ^{(*)9} | I_{REVS} | $V_{IN}=V_{CE}=5.0V, V_{OUT}=6.0V$ | - | 95 | 215 | μA | ① |
| | | $V_{IN}=5.0V, V_{CE}=V_{SS}, V_{OUT}=6.0V,$ XC6222A/C Series ^{(*)10} | - | 2.8 | 5.3 | μA | ① |
| Thermal Shutdown Detect Temperature | T_{TSD} | Junction Temperature | - | 150 | - | °C | ① |
| Thermal Shutdown Release Temperature | T_{TSR} | Junction Temperature | - | 125 | - | °C | ① |
| C_L Discharge Resistance ^{(*)11} | R_{DCHG} | $V_{IN}=6.0V, V_{OUT}=4.0V, V_{CE}=V_{SS}$ XC6222B/D Series ^{(*)11} | 370 | 530 | 690 | Ω | ① |

■ ELECTRICAL CHARACTERISTICS (Continued)

NOTE:

- * 1: Unless otherwise stated, input voltage is $V_{IN}=V_{OUT}(T)+1.0V$.
- * 2: $V_{OUT}(E)$ is effective output voltage (Refer to the voltage chart E-0 and E-1)
It is defined as output voltages when an amply stabilized $V_{OUT}(T) +1.0V$ is supplied to the V_{IN} pin while maintaining a certain I_{OUT} .
- * 3: The relation between $V_{OUT}(E)$ and $V_{OUT}(T)$ is shown in the voltage chart E-0 and E-1.
- * 4: $V_{OUT}(T)$ is nominal output voltage
- * 5: $V_{dif} = \{V_{IN1}^{(7)} - V_{OUT1}^{(6)}\}$
- * 6: V_{OUT1} equals 98% of the output voltage when amply stabilized $V_{OUT}(T) +1.0V$ are supplied to the V_{IN} pin.
- * 7: V_{IN1} is the input voltage when V_{OUT1} appears at the V_{OUT} pin while input voltage is gradually decreased.
- * 8: Reverse current (I_{REV}) flows from V_{OUT} to V_{IN} .
- * 9: V_{OUT} pin sink current (I_{REVS}) flows from V_{OUT} to V_{SS} .
- * 10: For the XC6222A/C series only. In the XC6222B/D series, the current flows from the V_{OUT} pin to the V_{SS} pin via the internal switch when CE pin is low. Please do not connect another power supply to the V_{OUT} pin. Please also note when the XC6222A/C series connects external power supply to the V_{OUT} pin, please use it within the range from $V_{OUT(E)}$ (actual output voltage value) or more to 6.0V or less. When the voltage less than $V_{OUT(E)}$ is applied to the V_{OUT} pin by adding a power supply or battery, a low level signal should be input to the CE pin for chip disable in order to protect a reverse current at $V_{IN} < V_{OUT}$.
- * 11: For the XC6222B/D series only. The XC6222A/C series discharges via two resistors R1 and R2 shown in the block diagram.

OUTPUT VOLTAGE CHART

● Voltage Chart 1

| SYMBOL | E-0 | | E-1 | | E-2 | |
|----------------------------|--------------------|--------|----------------------|------|----------------------|------|
| NOMINAL OUTPUT VOLTAGE (V) | OUTPUT VOLTAGE (V) | | LOAD REGULATION (mV) | | DROPOUT VOLTAGE (mV) | |
| $V_{OUT(T)}$ | $V_{OUT(E)}$ | | ΔV_{OUT} | | V_{dif} | |
| | MIN. | MAX. | TYP. | MAX. | TYP. | MAX. |
| 0.80 | 0.7800 | 0.8200 | 25 | 50 | 720 | 880 |
| 0.85 | 0.8300 | 0.8700 | 25 | 50 | 720 | 880 |
| 0.90 | 0.8800 | 0.9200 | 25 | 50 | 720 | 880 |
| 0.95 | 0.9300 | 0.9700 | 25 | 50 | 720 | 880 |
| 1.00 | 0.9800 | 1.0200 | 25 | 50 | 570 | 740 |
| 1.05 | 1.0300 | 1.0700 | 30 | 60 | 570 | 740 |
| 1.10 | 1.0800 | 1.1200 | 30 | 60 | 570 | 740 |
| 1.15 | 1.1300 | 1.1700 | 30 | 60 | 570 | 740 |
| 1.20 | 1.1800 | 1.2200 | 30 | 60 | 420 | 570 |
| 1.25 | 1.2300 | 1.2700 | 30 | 60 | 420 | 570 |
| 1.30 | 1.2800 | 1.3200 | 30 | 60 | 420 | 570 |
| 1.35 | 1.3300 | 1.3700 | 30 | 60 | 420 | 570 |
| 1.40 | 1.3800 | 1.4200 | 30 | 60 | 320 | 470 |
| 1.45 | 1.4300 | 1.4700 | 30 | 60 | 320 | 470 |
| 1.50 | 1.4800 | 1.5200 | 30 | 60 | 280 | 410 |
| 1.55 | 1.5300 | 1.5700 | 30 | 60 | 280 | 410 |
| 1.60 | 1.5800 | 1.6200 | 30 | 60 | 280 | 410 |
| 1.65 | 1.6300 | 1.6700 | 30 | 60 | 280 | 410 |
| 1.70 | 1.6800 | 1.7200 | 30 | 60 | 280 | 410 |
| 1.75 | 1.7300 | 1.7700 | 30 | 60 | 280 | 410 |
| 1.80 | 1.7800 | 1.8200 | 30 | 60 | 220 | 350 |
| 1.85 | 1.8300 | 1.8700 | 30 | 60 | 220 | 350 |
| 1.90 | 1.8800 | 1.9200 | 30 | 60 | 220 | 350 |
| 1.95 | 1.9300 | 1.9700 | 30 | 60 | 220 | 350 |
| 2.00 | 1.9800 | 2.0200 | 30 | 60 | 200 | 320 |
| 2.05 | 2.0295 | 2.0705 | 35 | 70 | 200 | 320 |
| 2.10 | 2.0790 | 2.1210 | 35 | 70 | 200 | 320 |
| 2.15 | 2.1285 | 2.1715 | 35 | 70 | 200 | 320 |
| 2.20 | 2.1780 | 2.2220 | 35 | 70 | 200 | 320 |
| 2.25 | 2.2275 | 2.2725 | 35 | 70 | 200 | 320 |
| 2.30 | 2.2770 | 2.3230 | 35 | 70 | 200 | 320 |
| 2.35 | 2.3265 | 2.3735 | 35 | 70 | 200 | 320 |
| 2.40 | 2.3760 | 2.4240 | 35 | 70 | 200 | 320 |
| 2.45 | 2.4255 | 2.4745 | 35 | 70 | 200 | 320 |
| 2.50 | 2.4750 | 2.5250 | 35 | 70 | 160 | 260 |
| 2.55 | 2.5245 | 2.5755 | 35 | 70 | 160 | 260 |
| 2.60 | 2.5740 | 2.6260 | 35 | 70 | 160 | 260 |
| 2.65 | 2.6235 | 2.6765 | 35 | 70 | 160 | 260 |
| 2.70 | 2.6730 | 2.7270 | 35 | 70 | 160 | 260 |
| 2.75 | 2.7225 | 2.7775 | 35 | 70 | 160 | 260 |
| 2.80 | 2.7720 | 2.8280 | 35 | 70 | 160 | 260 |
| 2.85 | 2.8215 | 2.8785 | 35 | 70 | 160 | 260 |
| 2.90 | 2.8710 | 2.9290 | 35 | 70 | 160 | 260 |
| 2.95 | 2.9205 | 2.9795 | 35 | 70 | 160 | 260 |

■ OUTPUT VOLTAGE CHART (Continued)

● Voltage Chart 2

| SYMBOL | E-0 | | E-1 | | E-2 | |
|----------------------------|--------------------|--------|----------------------|-----|----------------------|------|
| NOMINAL OUTPUT VOLTAGE (V) | OUTPUT VOLTAGE (V) | | LOAD REGULATION (mV) | | DROPOUT VOLTAGE (mV) | |
| $V_{OUT(T)}$ | $V_{OUT(E)}$ | | ΔV_{OUT} | | V_{dif} | |
| | MIN. | MAX. | TYP. | | MIN. | MAX. |
| 3.00 | 2.9700 | 3.0300 | 43 | 85 | 120 | 200 |
| 3.05 | 3.0195 | 3.0805 | 43 | 85 | 120 | 200 |
| 3.10 | 3.0690 | 3.1310 | 43 | 85 | 120 | 200 |
| 3.15 | 3.1185 | 3.1815 | 43 | 85 | 120 | 200 |
| 3.20 | 3.1680 | 3.2320 | 43 | 85 | 120 | 200 |
| 3.25 | 3.2175 | 3.2825 | 43 | 85 | 120 | 200 |
| 3.30 | 3.2670 | 3.3330 | 43 | 85 | 120 | 200 |
| 3.35 | 3.3165 | 3.3835 | 43 | 85 | 120 | 200 |
| 3.40 | 3.3660 | 3.4340 | 43 | 85 | 120 | 200 |
| 3.45 | 3.4155 | 3.4845 | 43 | 85 | 120 | 200 |
| 3.50 | 3.4650 | 3.5350 | 43 | 85 | 120 | 200 |
| 3.55 | 3.5145 | 3.5855 | 43 | 85 | 120 | 200 |
| 3.60 | 3.5640 | 3.6360 | 43 | 85 | 120 | 200 |
| 3.65 | 3.6135 | 3.6865 | 43 | 85 | 120 | 200 |
| 3.70 | 3.6630 | 3.7370 | 43 | 85 | 120 | 200 |
| 3.75 | 3.7125 | 3.7875 | 43 | 85 | 120 | 200 |
| 3.80 | 3.7620 | 3.8380 | 43 | 85 | 120 | 200 |
| 3.85 | 3.8115 | 3.8885 | 43 | 85 | 120 | 200 |
| 3.90 | 3.8610 | 3.9390 | 43 | 85 | 120 | 200 |
| 3.95 | 3.9105 | 3.9895 | 43 | 85 | 120 | 200 |
| 4.00 | 3.9600 | 4.0400 | 43 | 85 | 120 | 200 |
| 4.05 | 4.0095 | 4.0905 | 50 | 100 | 120 | 200 |
| 4.10 | 4.0590 | 4.1410 | 50 | 100 | 120 | 200 |
| 4.15 | 4.1085 | 4.1915 | 50 | 100 | 120 | 200 |
| 4.20 | 4.1580 | 4.2420 | 50 | 100 | 120 | 200 |
| 4.25 | 4.2075 | 4.2925 | 50 | 100 | 120 | 200 |
| 4.30 | 4.2570 | 4.3430 | 50 | 100 | 120 | 200 |
| 4.35 | 4.3065 | 4.3935 | 50 | 100 | 120 | 200 |
| 4.40 | 4.3560 | 4.4440 | 50 | 100 | 120 | 200 |
| 4.45 | 4.4055 | 4.4945 | 50 | 100 | 120 | 200 |
| 4.50 | 4.4550 | 4.5450 | 50 | 100 | 120 | 200 |
| 4.55 | 4.5045 | 4.5955 | 50 | 100 | 120 | 200 |
| 4.60 | 4.5540 | 4.6460 | 50 | 100 | 120 | 200 |
| 4.65 | 4.6035 | 4.6965 | 50 | 100 | 120 | 200 |
| 4.70 | 4.6530 | 4.7470 | 50 | 100 | 120 | 200 |
| 4.75 | 4.7025 | 4.7975 | 50 | 100 | 120 | 200 |
| 4.80 | 4.7520 | 4.8480 | 50 | 100 | 120 | 200 |
| 4.85 | 4.8015 | 4.8985 | 50 | 100 | 120 | 200 |
| 4.90 | 4.8510 | 4.9490 | 50 | 100 | 120 | 200 |
| 4.95 | 4.9005 | 4.9995 | 50 | 100 | 120 | 200 |
| 5.00 | 4.9500 | 5.0500 | 50 | 100 | 120 | 200 |

OPERATIONAL EXPLANATION

The voltage divided by two resistors R1 and R2 is compared with the internal reference voltage by the error amplifier. The P-channel MOSFET connected to the V_{OUT} pin, is then driven by the subsequent output signal. The output voltage at the V_{OUT} pin is controlled and stabilized by a system of negative feedback. The current limit and short protection operate in relation to the level of output current. The thermal protection operates in relation to the level of heat generation. The reverse current protection operates when V_{OUT} voltage is higher than V_{IN} voltage. Further, the IC's internal circuitry can be turned off via the CE pin's signal.



<Input and Output Capacitors>

The XC6222 needs an output capacitor C_L for phase compensation. Values required for the phase compensation are shown in the chart below. If a loss of the capacitance happens, stable phase compensation may not be obtained. Please ensure to use a capacitor which does not depend on bias or temperature too much. For a stable power input, please connect an input capacitor C_{IN} of 1.0 μF between the V_{IN} pin and the V_{SS} pin.

● Output Capacitor (C_L) Table

| OUTPUT VOLTAGE (V) | OUTPUT CAPACITOR VALUE |
|--------------------|-------------------------------|
| 0.8V~2.05V | C _L =6.8 μF (MIN.) |
| 2.1V~2.45V | C _L =4.7 μF (MIN.) |
| 2.5V~5.0V | C _L =2.2 μF (MIN.) |

<Reverse Current Protection>

The XC6222 series includes reverse current protection to prevent the damage to any connected products such as batteries as a result of current flow from the V_{OUT} pin to the V_{IN} pin. When V_{IN} is smaller than V_{OUT}, the reverse current protection works and suppress the reverse current to 1.5 μA (MAX.). When V_{IN} is smaller than V_{OUT}, the V_{OUT} pin sink current flows from the V_{OUT} pin to the V_{SS} pin is 95 μA (TYP.) as the IC operation current. With the XC6222A/C series, when a low level signal is inputted to the CE pin, the sink current of the V_{OUT} pin is minimized to 2.8 μA (TYP.). However, with the XC6222B/D series, when a low level signal is inputted to the CE pin, the sink current of the V_{OUT} pin goes through the C_L auto discharge circuit to the V_{SS} pin which may result in the IC being damaged. In this case, please do not connect a power supply to the V_{OUT} pin.

Please also note when the XC6222A/C series connects external power supply to the V_{OUT} pin, please use it within the range from V_{OUT(E)} (actual output voltage value) or more to 6.0V or less. When the voltage less than V_{OUT(E)} is applied to the V_{OUT} pin by adding a power supply or battery, a low level signal should be input to the CE pin for chip disable in order to protect a reverse current at V_{IN} < V_{OUT}.

Example) The voltage less than V_{OUT(E)} (actual output voltage value) is applied to the V_{OUT} pin as "OR" connection.



<Current Limiter, Short-Circuit Protection>

The XC6222 series' fold-back circuit operates as an output current limiter and a short protection circuit for the output pin. When the load current reaches the current limit level, the fixed current limiter circuit operates and output voltage drops. When the output pin is short-circuited to the V_{SS} pin, the current is decreased to a level of 55mA.

<Thermal Shutdown>

When the junction temperature of the built-in driver transistor reaches the temperature limit level (150°C TYP.), the thermal shutdown circuit operates and the driver transistor will be turned OFF. The IC resumes its operation when the thermal shutdown function is released and the IC's operation is automatically restored because the junction temperature drops to the level of 125°C (TYP.) as the thermal shutdown release voltage.

■ OPERATIONAL EXPLANATION (Continued)

<C_L Auto-Discharge Function>

XC6222B/D series can discharge the electric charge stored in the output capacitor (C_L), when a low signal to the CE pin, which enables the whole IC circuit to be turned off, is inputted via the N-channel transistor located between the V_{OUT} pin and the V_{SS} pin (cf. BLOCK DIAGRAM). The CL auto-discharge resistance value is set at 530Ω (TYP.). The discharge time of the output capacitor (C_L) is set by the CL auto-discharge resistance (R) and the output capacitor (C_L). By setting the time constant of the C_L auto-discharge resistance value [R_{DCHG}] and the output capacitor value (C_L) as τ ($\tau = C \times R_{DCHG}$), the output voltage after discharge via the N-channel transistor is calculated by the following formula.

$$V = V_{OUT(E)} \times e^{-t/\tau}, \text{ or } t = \tau \ln (V / V_{OUT(E)})$$

where

V: Output voltage after discharge

V_{OUT(E)}: Output voltage

t: Discharge time

τ : C_L auto-discharge resistance R_{DCHG} × Output capacitor (C_L) value C

<CE Pin>

The entire XC6222 circuitry can be turned off via the CE pin signal. In shutdown mode, output at the V_{OUT} pin will be pulled down to the V_{SS} level via R1 & R2. However, with the XC6222B series, the CL auto-discharge resistor is connected in parallel to R1 and R2 while the power supply is applied to the V_{IN} pin. Therefore, time until the V_{OUT} pin reaches the V_{SS} level is shorter. For the XC6222A/B series, the output voltage becomes unstable, when the CE pin is left open. If this CE pin voltage is set with the specified voltage range, the logic is fixed and the IC will operate normally. However, the supply current may increase as a result of shoot-through current in the IC's internal circuitry when a medium voltage is input to the CE pin. With the XC6222C/D series, when the CE pin is left open, output voltage is fixed to V_{SS} level.

■ NOTES ON USE

1. Please use this IC within the stated absolute maximum ratings. The IC is liable to malfunction should the ratings be exceeded.
2. Where wiring impedance is high, operations may become unstable due to noise and/or phase lag depending on output current.
Please wire the input capacitor (C_{IN}) and the output capacitor (C_L) as close to the IC as possible.

TEST CIRCUITS

● Circuit ①



● Circuit ②



● Circuit ③



* C_{IN} : 1.0 μ F or higher
 C_L : 2.2 μ F or higher ($V_{OUT}=2.5\sim 5.0V$)
 4.7 μ F or higher ($V_{OUT}=2.1\sim 2.45V$)
 6.8 μ F or higher ($V_{OUT}=0.8\sim 2.05V$)

TYPICAL PERFORMANCE CHARACTERISTICS

(1) Output Voltage vs. Output Current

*CE Voltage condition: unless otherwise stated $V_{CE}=V_{IN}$

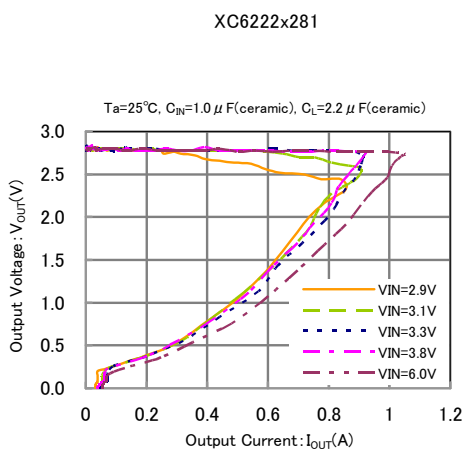
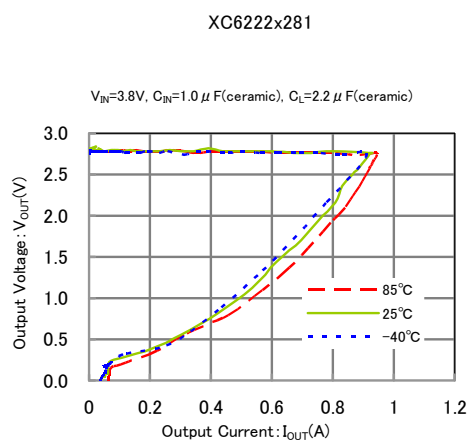
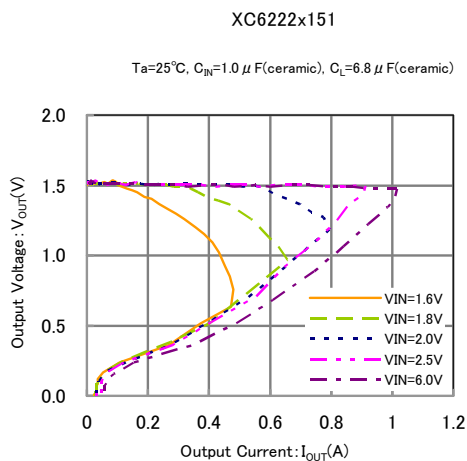
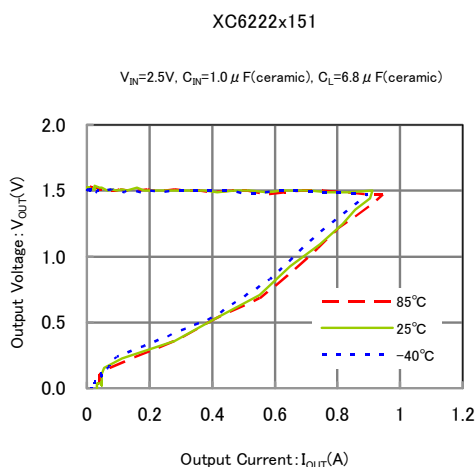
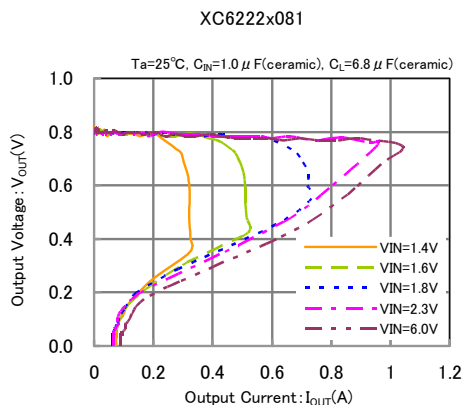
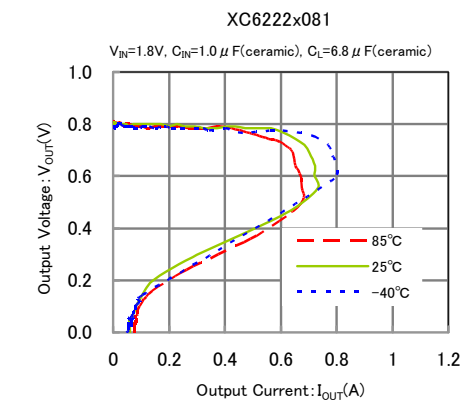

TYPICAL PERFORMANCE CHARACTERISTICS (Continued)

(1) Output Voltage vs. Output Current (Continued)



(2) Output Voltage vs. Input Current



■ TYPICAL PERFORMANCE CHARACTERISTICS (Continued)

(2) Output Voltage vs. Input Current (Continued)



(3) Dropout Voltage vs. Output Current



TYPICAL PERFORMANCE CHARACTERISTICS (Continued)

(3) Dropout Voltage vs. Output Current (Continued)



(4) Supply Current vs. Input Voltage



■ TYPICAL PERFORMANCE CHARACTERISTICS (Continued)

(5) Output Voltage vs. Ambient Temperature

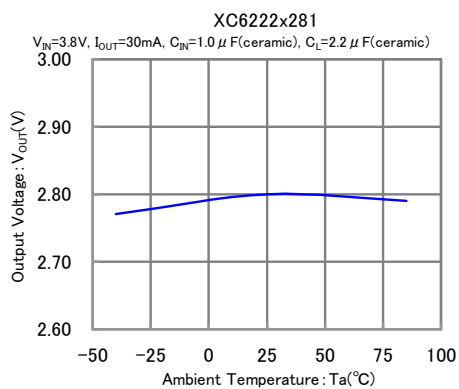
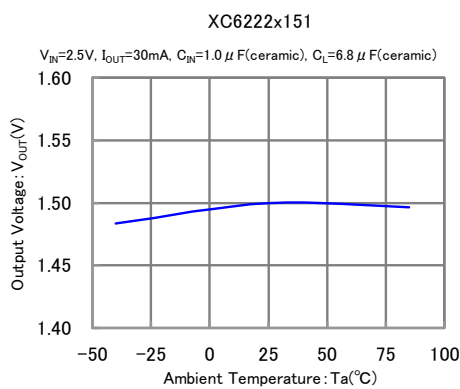
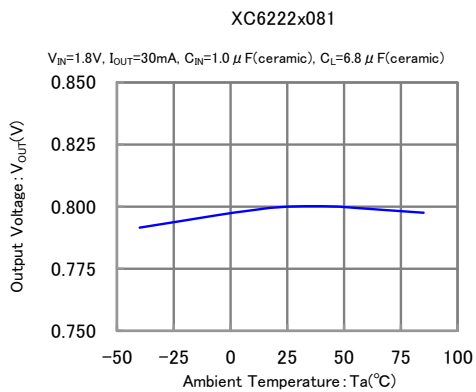

(6) CE Pin Threshold Voltage vs. Ambient Temperature



(7) Reverse Current vs. Output Voltage

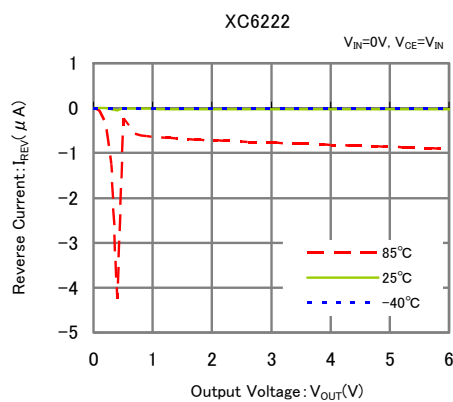

TYPICAL PERFORMANCE CHARACTERISTICS (Continued)

(8) V_{OUT} Sink Current vs. Output Voltage



TYPICAL PERFORMANCE CHARACTERISTICS (Continued)

(9) Input Transient Response 1



(10) CE Rising Response Time



TYPICAL PERFORMANCE CHARACTERISTICS (Continued)

(10) CE Rising Response Time (Continued)



(11) Input Transient Response 2

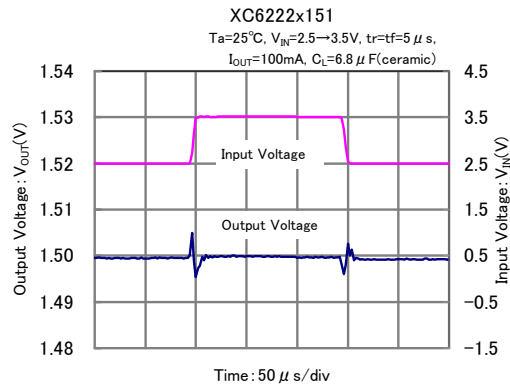

■ TYPICAL PERFORMANCE CHARACTERISTICS (Continued)

(12) Load Transient Response

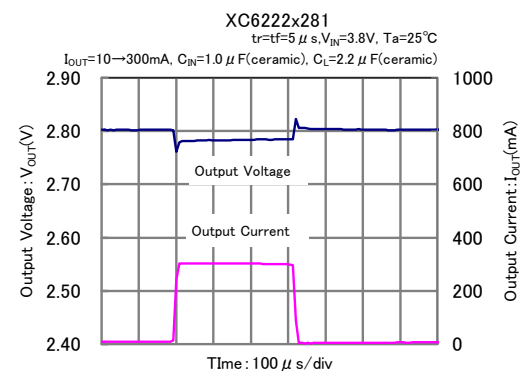
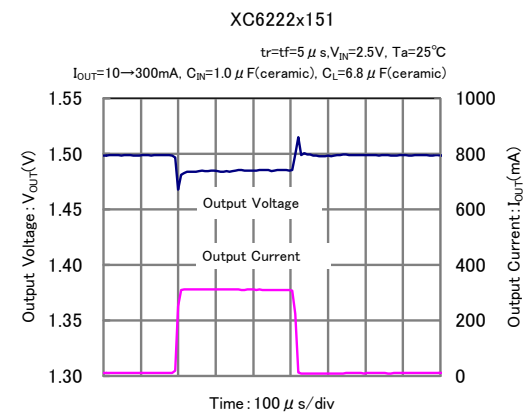

TYPICAL PERFORMANCE CHARACTERISTICS (Continued)

(12) Load Transient Response (Continued)



(13) Ripple Rejection Rate

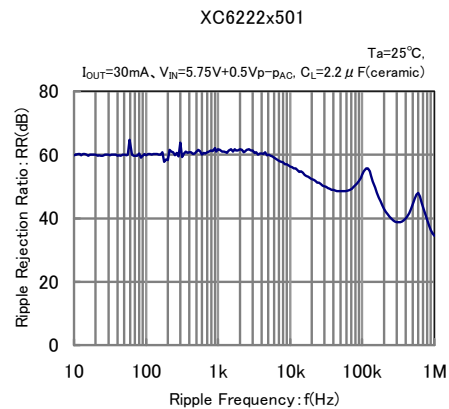
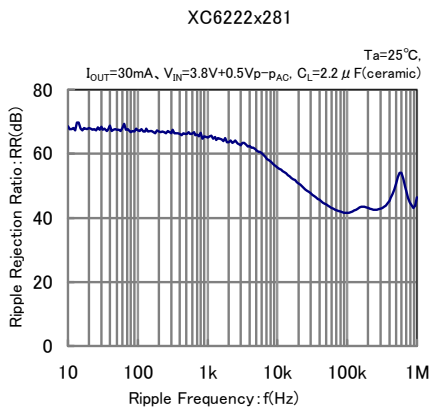

■ **PACKAGING INFORMATION**

● **SOT-25**

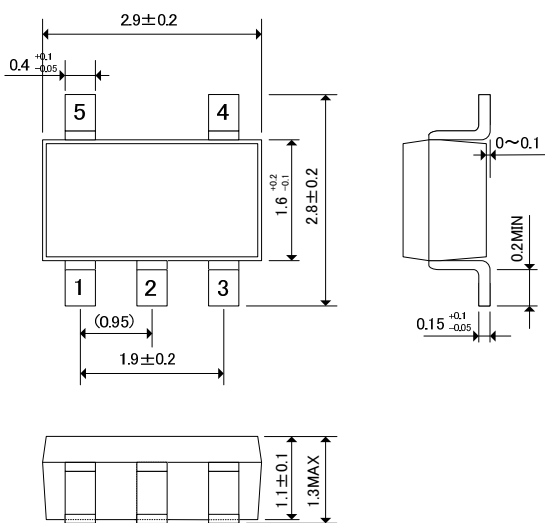

● **SOT-89-5**



● **USP-6C**



● **USP-6C Reference Pattern Layout**

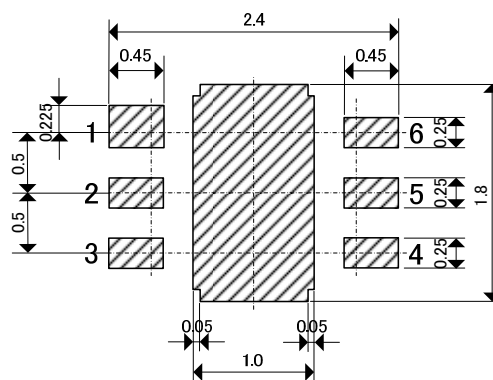

● **USP-6C Reference Metal Mask Design**



PACKAGING INFORMATION (Continued)

- USP-6C Power Dissipation

Power dissipation data for the USP-6C is shown in this page.

The value of power dissipation varies with the mount board conditions.

Please use this data as one of reference data taken in the described condition.

1. Measurement Condition (Reference data)

- Condition: Mount on a board
- Ambient: Natural convection
- Soldering: Lead (Pb) free
- Board: Dimensions 40 x 40 mm (1600 mm² in one side)
Copper (Cu) traces occupy 50% of the board area
In top and back faces
Package heat-sink is tied to the copper traces
- Material: Glass Epoxy (FR-4)
- Thickness: 1.6 mm
- Through-hole: 4 x 0.8 Diameter



Evaluation Board (Unit: mm)

2. Power Dissipation vs. Ambient Temperature

Board Mount ($T_j \text{ max} = 125^\circ\text{C}$)

| Ambient Temperature (°C) | Power Dissipation Pd (mW) | Thermal Resistance (°C/W) |
|--------------------------|---------------------------|---------------------------|
| 25 | 1000 | 100.00 |
| 85 | 400 | |



■ PACKAGING INFORMATION (Continued)

● SOT-25 Power Dissipation

Power dissipation data for the SOT-25 is shown in this page.
The value of power dissipation varies with the mount board conditions.
Please use this data as one of reference data taken in the described condition.

2. Measurement Condition (Reference data)

- Condition: Mount on a board
- Ambient: Natural convection
- Soldering: Lead (Pb) free
- Board: Dimensions 40 x 40 mm (1600 mm² in one side)
Copper (Cu) traces occupy 50% of the board area
In top and back faces
Package heat-sink is tied to the copper traces
(Board of SOT-26 is used.)
- Material: Glass Epoxy (FR-4)
- Thickness: 1.6 mm
- Through-hole: 4 x 0.8 Diameter

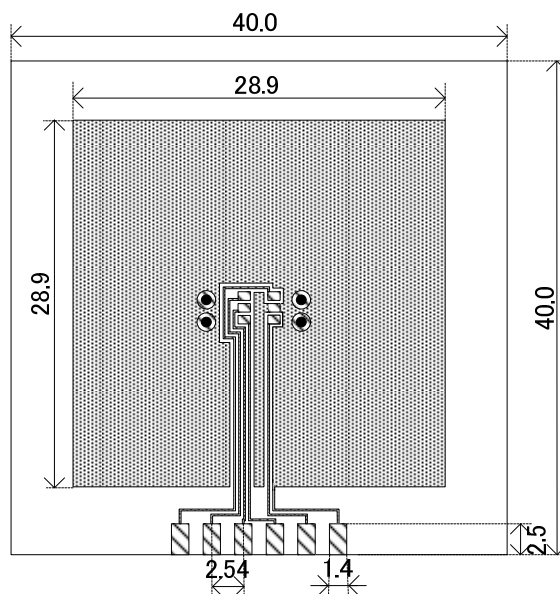

Evaluation Board (Unit: mm)

2. Power Dissipation vs. Ambient Temperature

Board Mount ($T_j \text{ max} = 125^\circ\text{C}$)

| Ambient Temperature (°C) | Power Dissipation Pd (mW) | Thermal Resistance (°C/W) |
|--------------------------|---------------------------|---------------------------|
| 25 | 600 | 166.67 |
| 85 | 240 | |



PACKAGING INFORMATION (Continued)

SOT-89-5 Power Dissipation

Power dissipation data for the SOT-89-5 is shown in this page.
 The value of power dissipation varies with the mount board conditions.
 Please use this data as one of reference data taken in the described condition.

1. Measurement Condition (Reference data)

- Condition: Mount on a board
- Ambient: Natural convection
- Soldering: Lead (Pb) free
- Board: Dimensions 40 x 40 mm (1600 mm² in one side)
 Copper (Cu) traces occupy 50% of the board area
 In top and back faces
 Package heat-sink is tied to the copper traces
- Material: Glass Epoxy (FR-4)
- Thickness: 1.6 mm
- Through-hole: 5 x 0.8 Diameter



Evaluation Board (Unit: mm)

2. Power Dissipation vs. Ambient Temperature

Board Mount ($T_j \text{ max} = 125^\circ\text{C}$)

| Ambient Temperature (°C) | Power Dissipation Pd (mW) | Thermal Resistance (°C/W) |
|--------------------------|---------------------------|---------------------------|
| 25 | 1300 | 76.92 |
| 85 | 520 | |

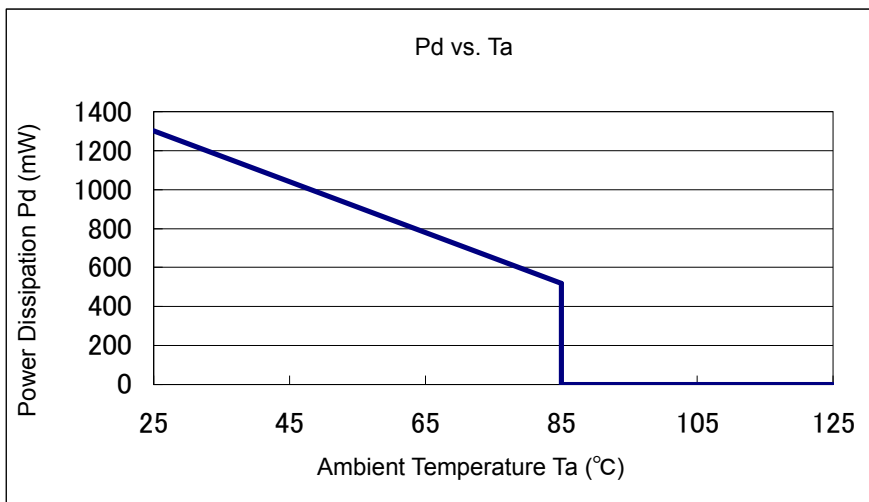

MARKING RULE

① represents product series

| MARK | PRODUCT SERIES |
|------|----------------|
| N | XC6222*****-G |

② represents regulator type, voltage range, and accuracy

| MARK | REGULATOR TYPE | OUTPUT VOLTAGE RANGE | ACCURACY | PRODUCT SERIES |
|------|----------------|----------------------|----------|-------------------------------|
| C | A | 0.8~2.9 | 1 | XC6222A081**-G~XC6222A291**-G |
| D | A | 0.85~2.95 | B | XC6222A08B**-G~XC6222A29B**-G |
| E | A | 3.0~5.0 | 1 | XC6222A301**-G~XC6222A501**-G |
| F | A | 3.05~4.95 | B | XC6222A30B**-G~XC6222A49B**-G |
| H | B | 0.8~2.9 | 1 | XC6222B081**-G~XC6222B291**-G |
| K | B | 0.85~2.95 | B | XC6222B08B**-G~XC6222B29B**-G |
| L | B | 3.0~5.0 | 1 | XC6222B301**-G~XC6222B501**-G |
| M | B | 3.05~4.95 | B | XC6222B30B**-G~XC6222B49B**-G |
| N | C | 0.8~2.9 | 1 | XC6222C081**-G~XC6222C291**-G |
| P | C | 0.85~2.95 | B | XC6222C08B**-G~XC6222C29B**-G |
| R | C | 3.0~5.0 | 1 | XC6222C301**-G~XC6222C501**-G |
| S | C | 3.05~4.95 | B | XC6222C30B**-G~XC6222C49B**-G |
| T | D | 0.8~2.9 | 1 | XC6222D081**-G~XC6222D291**-G |
| U | D | 0.85~2.95 | B | XC6222D08B**-G~XC6222D29B**-G |
| V | D | 3.0~5.0 | 1 | XC6222D301**-G~XC6222D501**-G |
| X | D | 3.05~4.95 | B | XC6222D30B**-G~XC6222D49B**-G |

* Accuracy "1": 0.1V increments. Accuracy "B": 0.05V increments

③ represents output voltage

| MARK | OUTPUT VOLTAGE | | MARK | OUTPUT VOLTAGE | | MARK | OUTPUT VOLTAGE | |
|------|----------------|------|------|----------------|------|------|----------------|------|
| 0 | - | 3.0x | A | 1.0x | 4.0x | N | 2.0x | 5.0x |
| 1 | - | 3.1x | B | 1.1x | 4.1x | P | 2.1x | - |
| 2 | - | 3.2x | C | 1.2x | 4.2x | R | 2.2x | - |
| 3 | - | 3.3x | D | 1.3x | 4.3x | S | 2.3x | - |
| 4 | - | 3.4x | E | 1.4x | 4.4x | T | 2.4x | - |
| 5 | - | 3.5x | F | 1.5x | 4.5x | U | 2.5x | - |
| 6 | - | 3.6x | F | 1.6x | 4.6x | V | 2.6x | - |
| 7 | - | 3.7x | K | 1.7x | 4.7x | X | 2.7x | - |
| 8 | 0.8x | 3.8x | L | 1.8x | 4.8x | Y | 2.8x | - |
| 9 | 0.9x | 3.9x | M | 1.9x | 4.9x | Z | 2.9x | - |

④⑤ represents production lot number

01 to 09, 0A to 0Z, 11 to 9Z, A1 to A9, AA to Z9, ZA to ZZ in order.
(G, I, J, O, Q, W excluded. No character inversion used.)

● SOT-25



SOT89-5



USP6C





1. The products and product specifications contained herein are subject to change without notice to improve performance characteristics. Consult us, or our representatives before use, to confirm that the information in this datasheet is up to date.
2. We assume no responsibility for any infringement of patents, patent rights, or other rights arising from the use of any information and circuitry in this datasheet.
3. Please ensure suitable shipping controls (including fail-safe designs and aging protection) are in force for equipment employing products listed in this datasheet.
4. The products in this datasheet are not developed, designed, or approved for use with such equipment whose failure or malfunction can be reasonably expected to directly endanger the life of, or cause significant injury to, the user.
(e.g. Atomic energy; aerospace; transport; combustion and associated safety equipment thereof.)
5. Please use the products listed in this datasheet within the specified ranges.
Should you wish to use the products under conditions exceeding the specifications, please consult us or our representatives.
6. We assume no responsibility for damage or loss due to abnormal use.
7. All rights reserved. No part of this datasheet may be copied or reproduced without the prior permission of TOREX SEMICONDUCTOR LTD.

TOREX SEMICONDUCTOR LTD.

Looking for pricing, stock, or lifecycle information?

Click below to explore more details on WIN SOURCE:

-  [View XC6222A151PR-G on WIN SOURCE](#)
-  [Torex Semiconductor Ltd Information](#)

Optimize Your Supply Chain with WIN SOURCE Solutions

-  Global Sourcing Solution
-  Obsolete Management
-  Cost Control Management
-  Shortage Management
-  Alternative Solution
-  Excess Inventory Management