



THE DATASHEET OF
046274040000894+



0.5mm Pitch
SERIES

6274

0.5mmピッチ ストレート SMT 片面接点 スライドロック
0.5mmPitch Vertical SMT Single-sided contact Slide lock

標準タイプ
Standard type

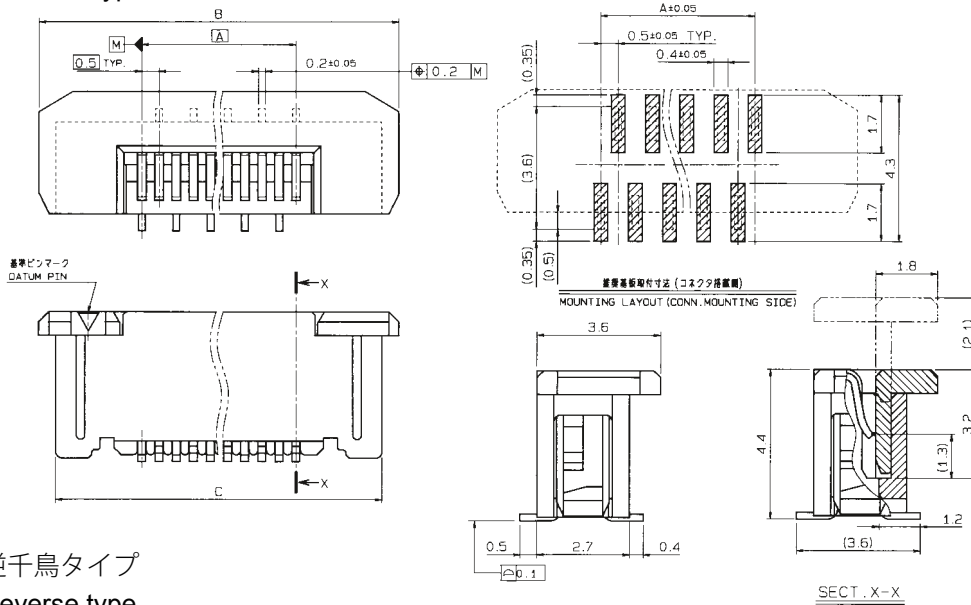

逆千鳥タイプ
Reverse type

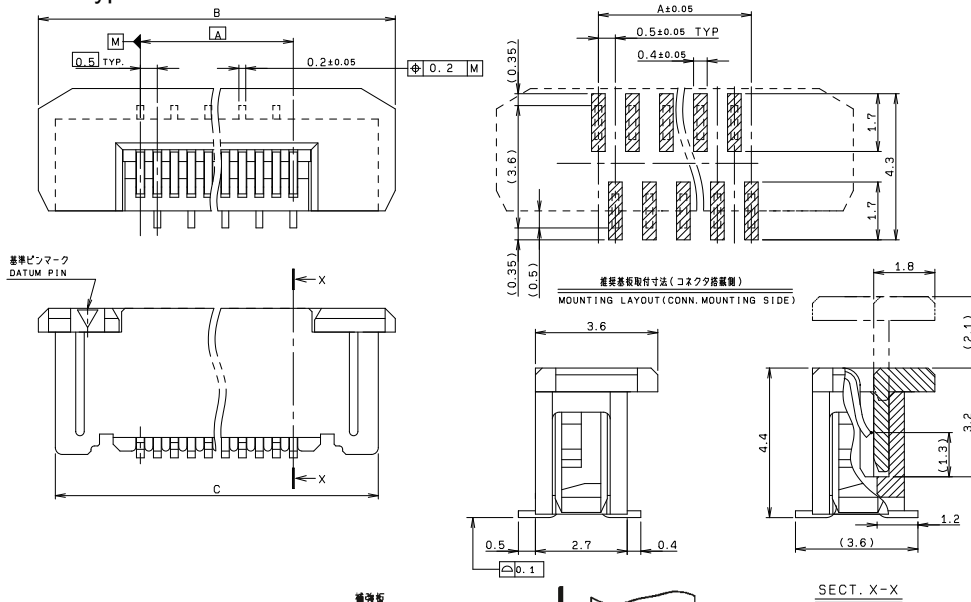

極数 NO. OF POS.	A	B	C
31	15.0	21.0	20.0
32	15.5	21.5	20.5
33	16.0	22.0	21.0
34	16.5	22.5	21.5
35	17.0	23.0	22.0
36	17.5	23.5	22.5
37	18.0	24.0	23.0
38	18.5	24.5	23.5
39	19.0	25.0	24.0
40	19.5	25.5	24.5
41	20.0	26.0	25.0
42	20.5	26.5	25.5
43	21.0	27.0	26.0
44	21.5	27.5	26.5
45	22.0	28.0	27.0
46	22.5	28.5	27.5
47	23.0	29.0	28.0
48	23.5	29.5	28.5
49	24.0	30.0	29.0
50	24.5	30.5	29.5

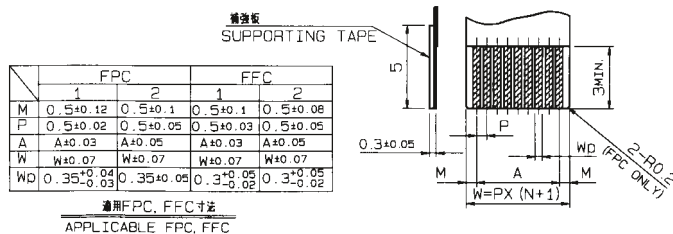

注文コード ORDERING CODE
04 6274 0XX X00 XXX+

RoHS 対応品
RoHS Compliant Product

極数 NUMBER OF
POSITIONS

0: 標準タイプ Standard type
1: 逆千鳥タイプ Reverse type

800+: スズ銅めっき Sn-Cu Plated
894+: 金めっき Au Plated

生産対応可能極数については、営業部に
ご確認ください。

Feel free to contact our sales department
for available numbers of positions.

0.5mm Pitch
SERIES

6274

エンボス梱包品
Tape and Reel Package

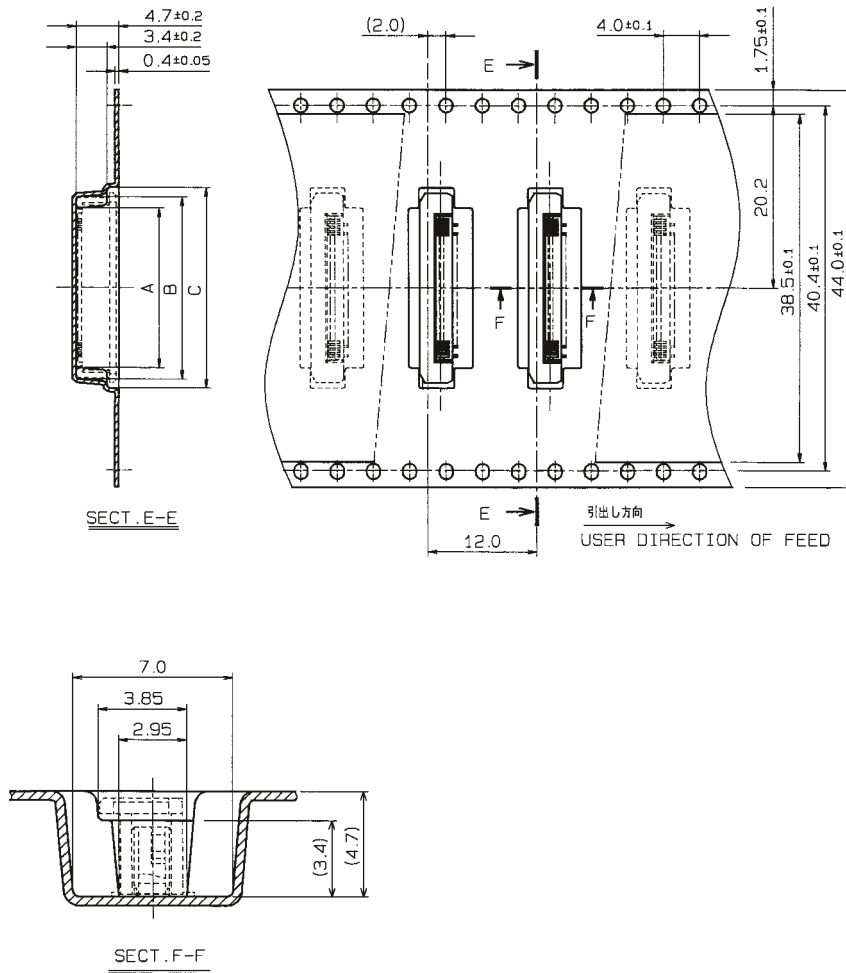

寸法表 DIMENSION			
極数 NO. OF POS.	A	B	C
31	17.7	20.2	22.2
32	18.2	20.7	22.7
33	18.7	21.2	23.2
34	19.2	21.7	23.7
35	19.7	22.2	24.2
36	20.2	22.7	24.7
37	20.7	23.2	25.2
38	21.2	23.7	25.7
39	21.7	24.2	26.2
40	22.2	24.7	26.7
41	22.7	25.2	27.2
42	23.2	25.7	27.7
43	23.7	26.2	28.2
44	24.2	26.7	28.7
45	24.7	27.2	29.2
46	25.2	27.7	29.7
47	25.7	28.2	30.2
48	26.2	28.7	30.7
49	26.7	29.2	31.2
50	27.2	29.7	31.7

注文コード ORDERING CODE
04 6274 0XX X00 XXX+

RoHS 対応品
RoHS Compliant Product

800+ : スズ銅めっき Sn-Cu Plated
894+ : 金めっき Au Plated
0 : 標準タイプ Standard type
1 : 逆千鳥タイプ Reverse type
極数 NUMBER OF POSITIONS

生産対応可能極数については、営業部にご確認願います。

Feel free to contact our sales department for available numbers of positions.

梱包数量 1000個/リール
PACKING QUANTITY 1000/Reel







Looking for pricing, stock, or lifecycle information?

Click below to explore more details on WIN SOURCE:

 [View 046274040000894+ on WIN SOURCE](#)

 [AVX Corp/Kyocera Corp](#) Information

Optimize Your Supply Chain with WIN SOURCE Solutions

-  Global Sourcing Solution
-  Obsolete Management
-  Cost Control Management
-  Shortage Management
-  Alternative Solution
-  Excess Inventory Management