

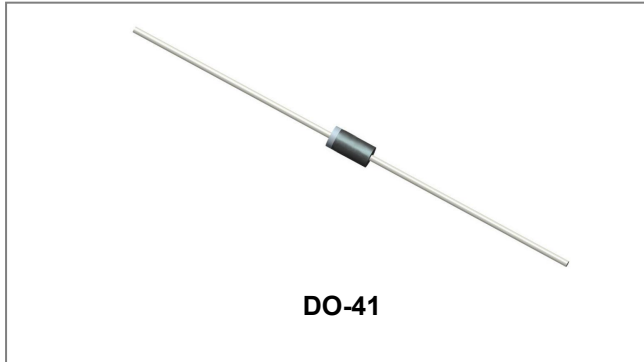

**THE DATASHEET OF
11DQ04TR**



11DQ03/11DQ04 SCHOTTKY RECTIFIER



Features

- Low profile, axial leaded outline
- High purity, high temperature epoxy encapsulation for enhanced mechanical strength and moisture resistance
- Very Low forward voltage drop
- High frequency operation
- Guard ring for enhanced ruggedness and long term reliability
- Terminals finish: Tin Lead-free plated
- This is a Pb – Free Device
- All SMC parts are traceable to the wafer lot
- Additional testing can be offered upon request

Circuit Diagram



Applications

- Switching power supply
- Converters
- Free-Wheeling diodes
- Reverse battery protection

Maximum Ratings(limiting values, $T_c = 25^\circ\text{C}$ unless otherwise specified)

Characteristics	Symbol	Condition	Max.	Units
Peak Repetitive Reverse Voltage Working Peak Reverse Voltage DC Blocking Voltage	V_{RRM} V_{RWM} V_R	-	30(11DQ03) 40(11DQ04)	V
Average Forward Current	$I_{F(AV)}$	50% duty cycle @ $T_c = 75^\circ\text{C}$, rectangular wave form On PC board 9mm ² island	1.1	A
Peak One Cycle Non-Repetitive Surge Current	I_{FSM}	8.3 ms, half Sine pulse	40	A

Electrical Characteristics:

Characteristics	Symbol	Condition	Typ.	Max.	Units
Forward Voltage Drop*	V_{F1}	@ 1 A, Pulse, $T_J = 25^\circ\text{C}$ @ 2 A, Pulse, $T_J = 25^\circ\text{C}$	0.47 0.59	0.55 0.71	V
	V_{F2}	@ 1 A, Pulse, $T_J = 125^\circ\text{C}$ @ 2 A, Pulse, $T_J = 125^\circ\text{C}$	0.42 0.57	0.50 0.61	V
Reverse Current*	I_{R1}	@ $V_R = \text{Rated } V_R$, Pulse, $T_J = 25^\circ\text{C}$	0.02	1	mA
	I_{R2}	@ $V_R = \text{Rated } V_R$, Pulse, $T_J = 125^\circ\text{C}$	4.5	6	mA
Junction Capacitance	C_T	@ $V_R = 5\text{V}$, $T_c = 25^\circ\text{C}$ $f_{SIG} = 1\text{MHz}$	46	60	PF
Typical Series Inductance	L_S	Measured lead to lead 5 mm from package body	8.0	-	nH
Voltage Rate of Change	dv/dt	-	-	10,000	V/ μs

* Pulse width < 300 μs , duty cycle < 2%

Thermal-Mechanical Specifications:

Characteristics	Symbol	Condition	Specification	Units
Junction Temperature	T_J	-	-40 to +150	$^{\circ}\text{C}$
Storage Temperature	T_{stg}	-	-40 to +150	$^{\circ}\text{C}$
Typical Thermal Resistance Junction to Ambient	$R_{\theta\text{JA}}$	-	100	$^{\circ}\text{C/W}$
Typical Thermal Resistance Junction to Lead	$R_{\theta\text{JL}}$	-	81	$^{\circ}\text{C/W}$
Approximate Weight	wt	-	0.34	g

Ratings and Characteristics Curves

Figure 1 Typical Forward Characteristics

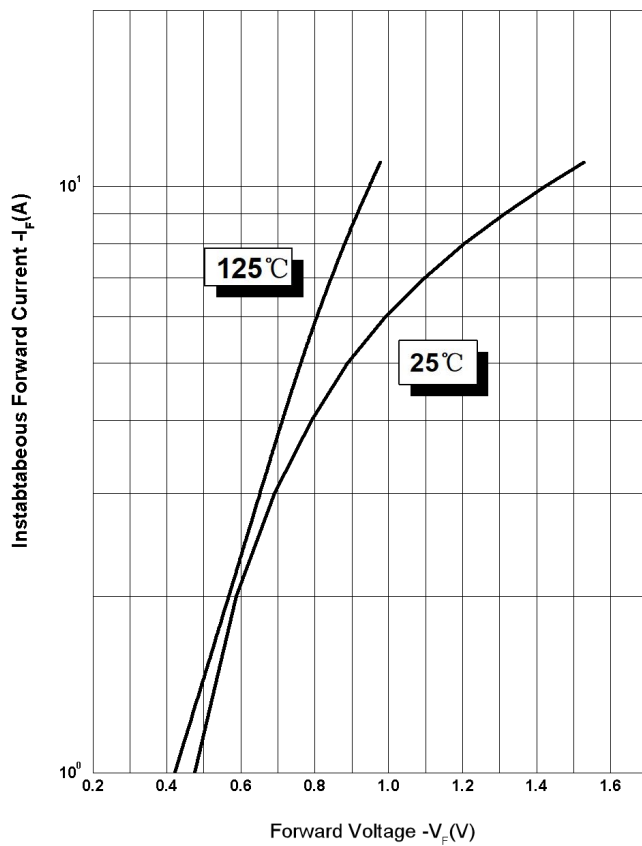

Figure 2 Typical Reverse Characteristics

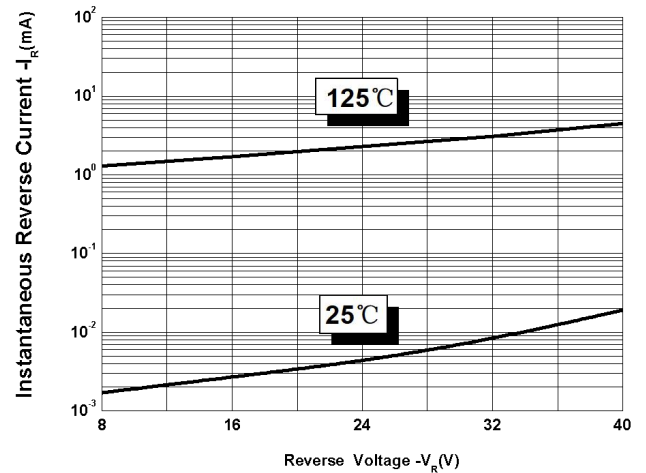
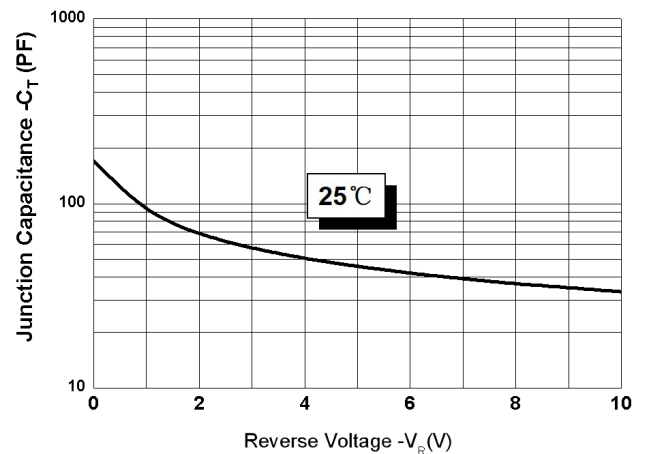
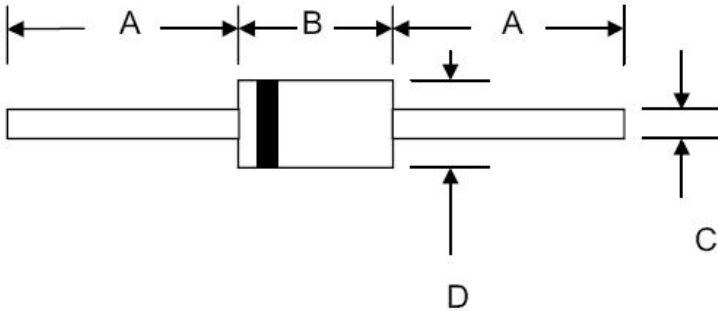

Figure 3 Typical Junction Capacitance



Mechanical Dimensions DO-41



SYMBOL	Millimeters		Inches	
	Min.	Max.	Min.	Max.
A	25.4	-	1.000	-
B	4.06	5.21	0.160	0.205
C	0.71	0.864	0.028	0.034
D	2.00	2.72	0.079	0.107

Ordering Information

Device	Package	Shipping
11DQ03 11DQ04	DO-41 (Pb-Free)	5000pcs /reel

For information on tape and reel specifications, including part orientation and tape sizes, please refer to our tape and reel packaging specification.

Marking Diagram



Where XXXXX is YYWWL

11DQ03 = Part Name
SSG = SSG
YY = Year
WW = Week
L = Lot Number

Caution: Molding resin
Epoxy resin UL:94V-0

Carrier Tape Specification DO-41

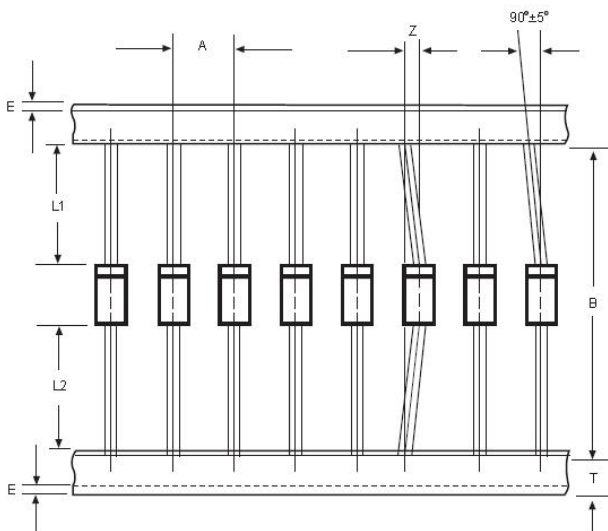



SYMBOL	Millimeters	
	Min.	Max.
A	4.50	5.50
B	50.9	53.9
Z	-	1.20
T	5.60	6.40
E	-	0.80
IL1-L2I	-	1.0

DISCLAIMER:

- 1- The information given herein, including the specifications and dimensions, is subject to change without prior notice to improve product characteristics. Before ordering, purchasers are advised to contact the SMC Diode Solutions sales department for the latest version of the datasheet(s).
- 2- In cases where extremely high reliability is required (such as use in nuclear power control, aerospace and aviation, traffic equipment, medical equipment, and safety equipment), safety should be ensured by using semiconductor devices that feature assured safety or by means of users' fail-safe precautions or other arrangement.
- 3- In no event shall SMC Diode Solutions be liable for any damages that may result from an accident or any other cause during operation of the user's units according to the datasheet(s). SMC Diode Solution assumes no responsibility for any intellectual property claims or any other problems that may result from applications of information, products or circuits described in the datasheets.
- 4- In no event shall SMC Diode Solutions be liable for any failure in a semiconductor device or any secondary damage resulting from use at a value exceeding the absolute maximum rating.
- 5- No license is granted by the datasheet(s) under any patents or other rights of any third party or SMC Diode Solutions.
- 6- The datasheet(s) may not be reproduced or duplicated, in any form, in whole or part, without the expressed written permission of SMC Diode Solutions.
- 7- The products (technologies) described in the datasheet(s) are not to be provided to any party whose purpose in their application will hinder maintenance of international peace and safety nor are they to be applied to that purpose by their direct purchasers or any third party. When exporting these products (technologies), the necessary procedures are to be taken in accordance with related laws and regulations..

Looking for pricing, stock, or lifecycle information?

Click below to explore more details on WIN SOURCE:

-  [View 11DQ04TR](#) on WIN SOURCE
-  [SMC Diode Solutions](#) Information

Optimize Your Supply Chain with WIN SOURCE Solutions

-  Global Sourcing Solution
-  Obsolete Management
-  Cost Control Management
-  Shortage Management
-  Alternative Solution
-  Excess Inventory Management