



THE DATASHEET OF BCR179F



PNP Silicon Digital Transistor

- Switching circuit, inverter, interface circuit, driver circuit.
- Built in bias resistor ($R_1 = 10\text{ k}\Omega$)

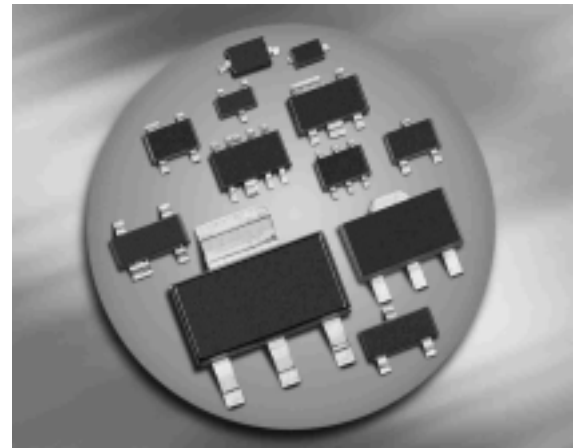
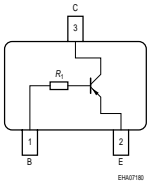
**BCR179F/L3
BCR179T**

Type	Marking	Pin Configuration						Package
		1=B	2=E	3=C	-	-	-	
BCR179F	WWs	1=B	2=E	3=C	-	-	-	TSFP-3
BCR179L3	WW	1=B	2=E	3=C	-	-	-	TSLP-3-4
BCR179T	WW	1=B	2=E	3=C	-	-	-	SC75

Maximum Ratings

Parameter	Symbol	Value	Unit
Collector-emitter voltage	V_{CEO}	50	V
Collector-base voltage	V_{CBO}	50	
Input forward voltage	$V_{i(fwd)}$	40	
Input reverse voltage	$V_{i(rev)}$	5	
Collector current	I_C	100	mA
Total power dissipation	P_{tot}		mW
BCR179F, $T_S \leq 128^\circ\text{C}$		250	
BCR179L3, $T_S \leq 135^\circ\text{C}$		250	
BCR179T, $T_S \leq 109^\circ\text{C}$		250	
Junction temperature	T_j	150	$^\circ\text{C}$
Storage temperature	T_{stg}	-65 ... 150	

Thermal Resistance

Parameter	Symbol	Value	Unit
Junction - soldering point ¹⁾	R_{thJS}		K/W
BCR179F		≤ 90	
BCR179L3		≤ 60	
BCR179T		≤ 165	

Electrical Characteristics at $T_A = 25^\circ\text{C}$, unless otherwise specified

Parameter	Symbol	Values			Unit
		min.	typ.	max.	

DC Characteristics

Collector-emitter breakdown voltage $I_C = 100 \mu\text{A}, I_B = 0$	$V_{(BR)CEO}$	50	-	-	V
Collector-base breakdown voltage $I_C = 10 \mu\text{A}, I_E = 0$	$V_{(BR)CBO}$	50	-	-	
Collector-base cutoff current $V_{CB} = 40 \text{V}, I_E = 0$	I_{CBO}	-	-	100	nA
Emitter-base cutoff current $V_{EB} = 5 \text{V}, I_C = 0$	I_{EBO}	-	-	100	nA
DC current gain ²⁾ $I_C = 5 \text{mA}, V_{CE} = 5 \text{V}$	h_{FE}	120	-	630	-
Collector-emitter saturation voltage ²⁾ $I_C = 10 \text{mA}, I_B = 0.5 \text{mA}$	V_{CEsat}	-	-	0,3	V
Input off voltage $I_C = 100 \mu\text{A}, V_{CE} = 5 \text{V}$	$V_{i(off)}$	0.4	-	1	
Input on voltage $I_C = 2 \text{mA}, V_{CE} = 0.3 \text{V}$	$V_{i(on)}$	0.5	-	1.1	
Input resistor	R_1	7	10	13	kΩ

AC Characteristics

Transition frequency $I_C = 10 \text{mA}, V_{CE} = 5 \text{V}, f = 100 \text{MHz}$	f_T	-	150	-	MHz
Collector-base capacitance $V_{CB} = 10 \text{V}, f = 1 \text{MHz}$	C_{cb}	-	1.2	-	pF

¹For calculation of R_{thJA} please refer to Application Note Thermal Resistance

²Pulse test: $t < 300 \mu\text{s}; D < 2\%$

DC current gain $h_{FE} = f(I_C)$

$V_{CE} = 5\text{ V}$ (common emitter configuration)

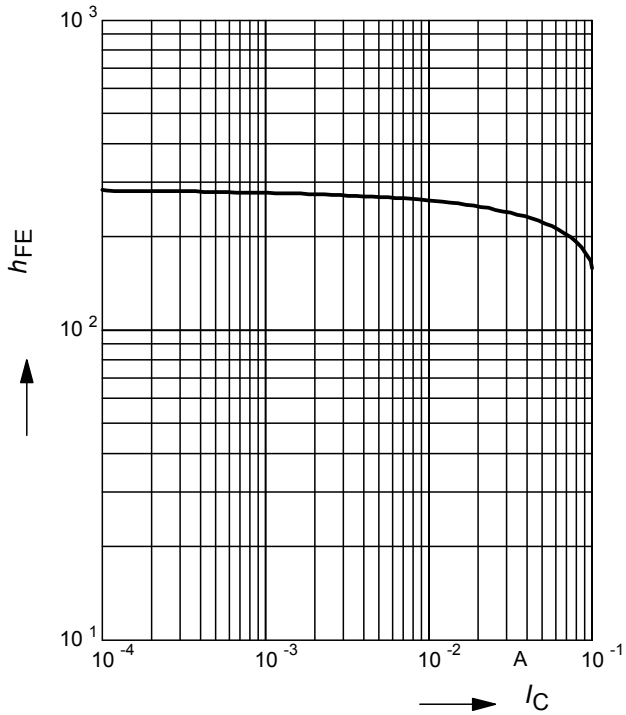

Collector-emitter saturation voltage

$V_{CEsat} = f(I_C), h_{FE} = 20$

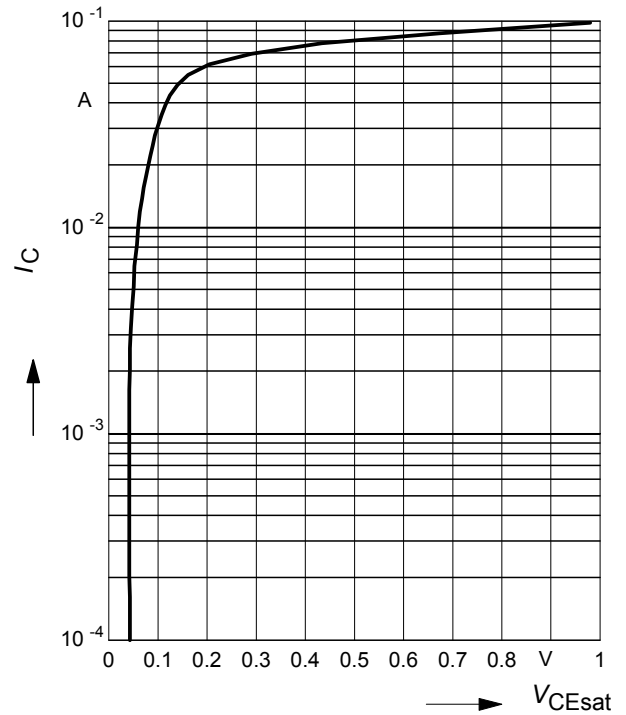

Input on Voltage $V_{i(on)} = f(I_C)$

$V_{CE} = 0.3\text{ V}$ (common emitter configuration)

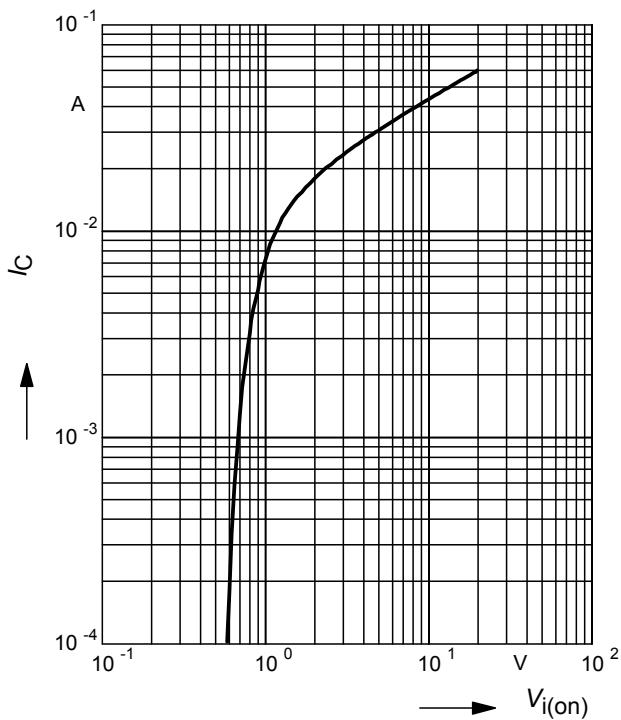

Input off voltage $V_{i(off)} = f(I_C)$

$V_{CE} = 5\text{ V}$ (common emitter configuration)

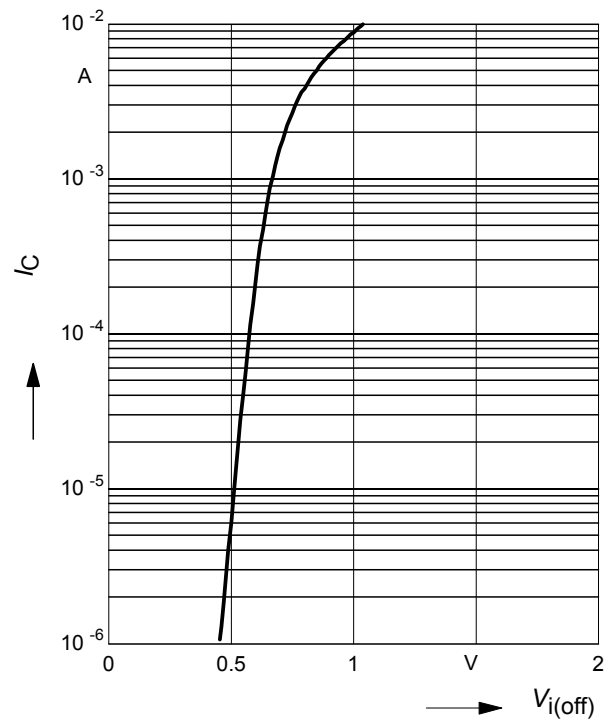

Total power dissipation $P_{\text{tot}} = f(T_S)$

BCR179F

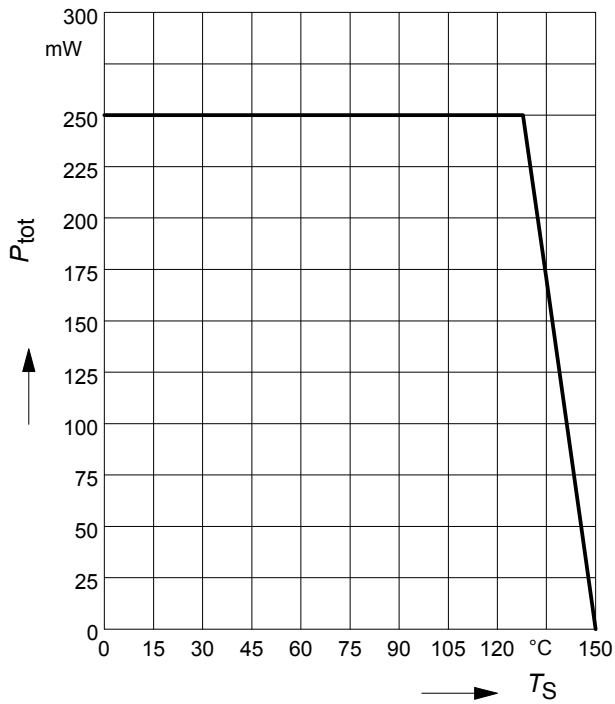

Total power dissipation $P_{\text{tot}} = f(T_S)$

BCR179L3

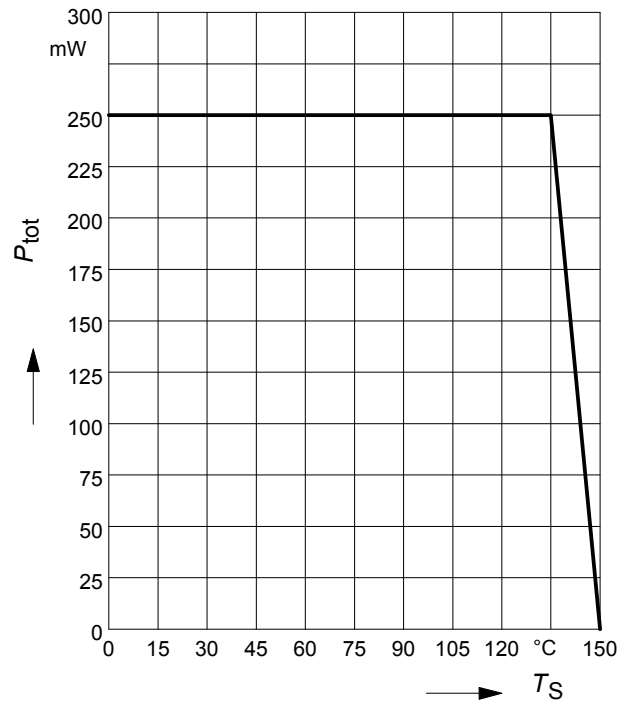

Total power dissipation $P_{\text{tot}} = f(T_S)$

BCR179T

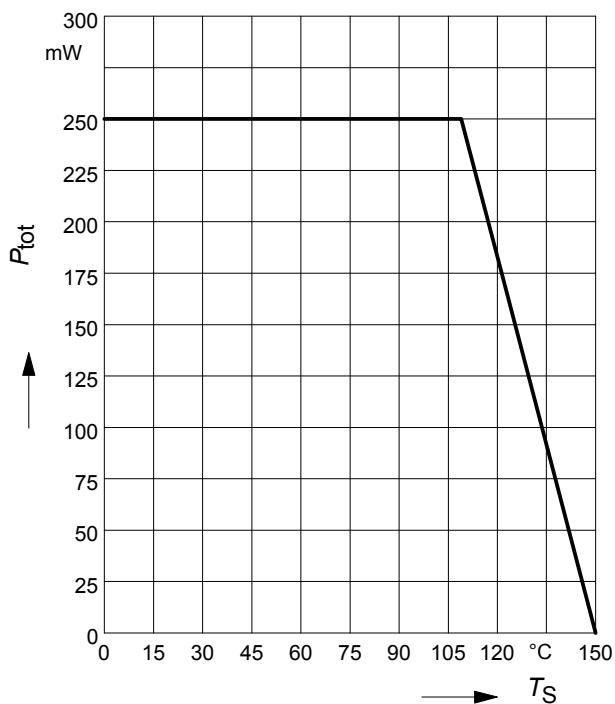

Permissible Puls Load $R_{thJS} = f(t_p)$

BCR179F

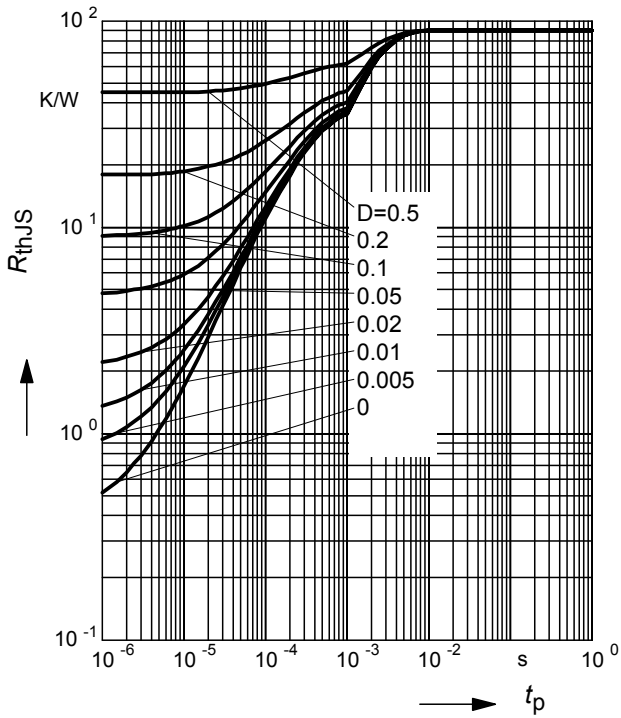

Permissible Pulse Load

$P_{totmax}/P_{totDC} = f(t_p)$

BCR179F

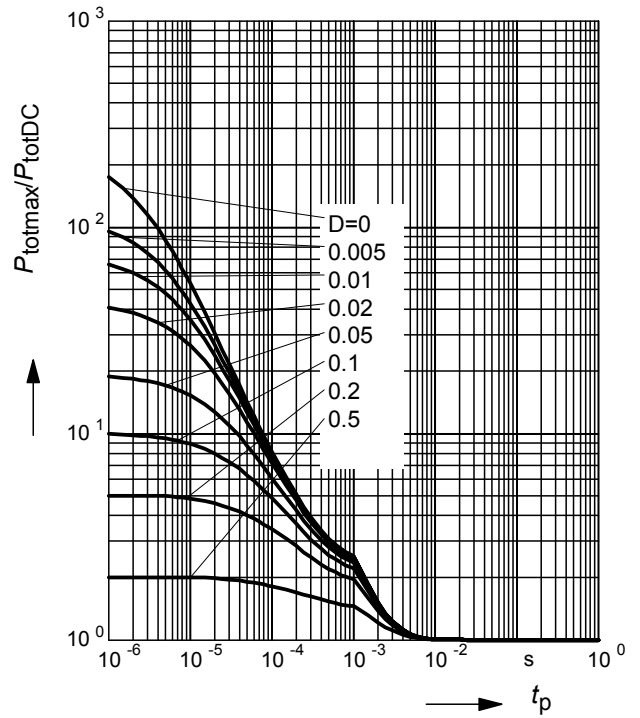

Permissible Puls Load $R_{thJS} = f(t_p)$

BCR179L3

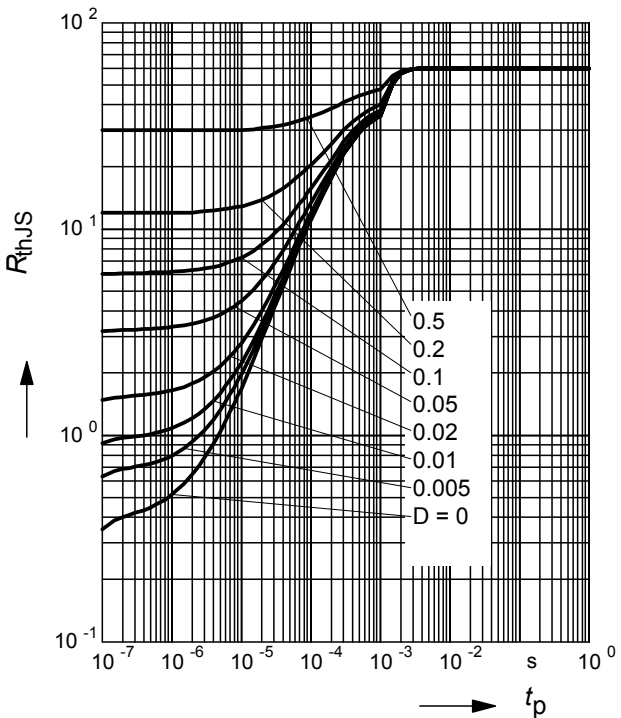

Permissible Pulse Load

$P_{totmax}/P_{totDC} = f(t_p)$

BCR179L3

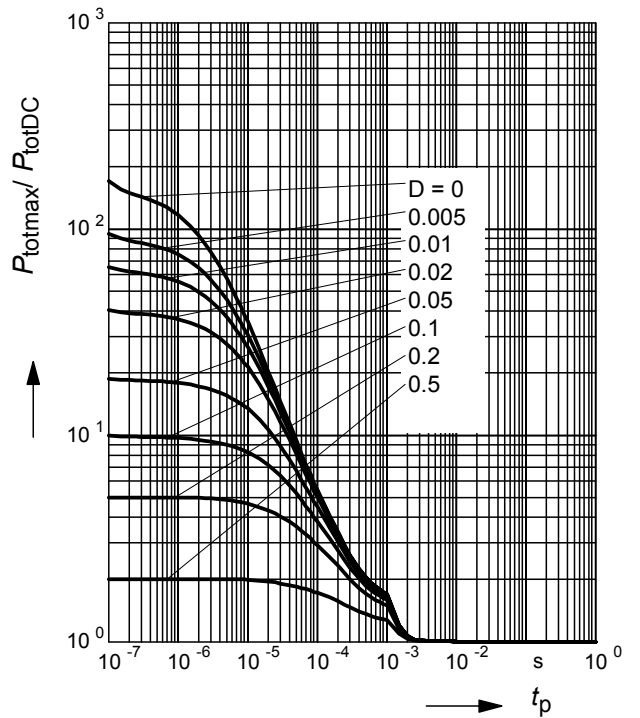

Permissible Puls Load $R_{thJS} = f(t_p)$

BCR179T

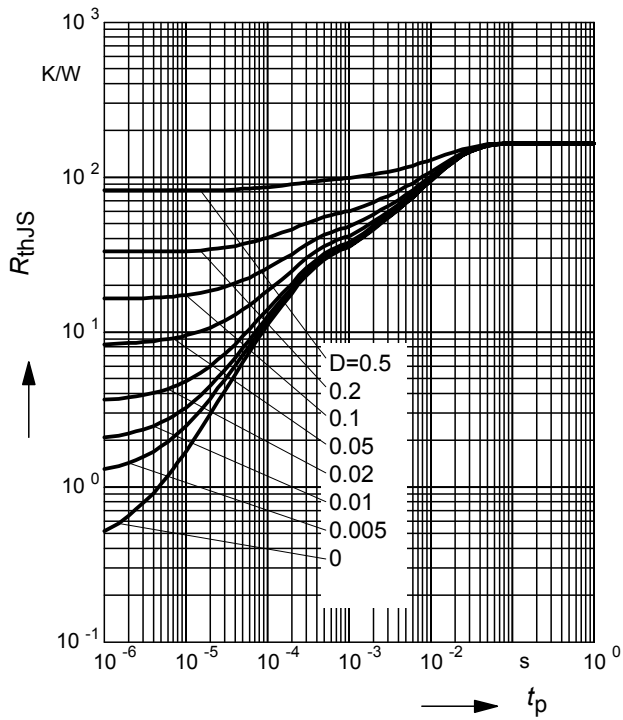

Permissible Pulse Load

$P_{totmax}/P_{totDC} = f(t_p)$

BCR179T

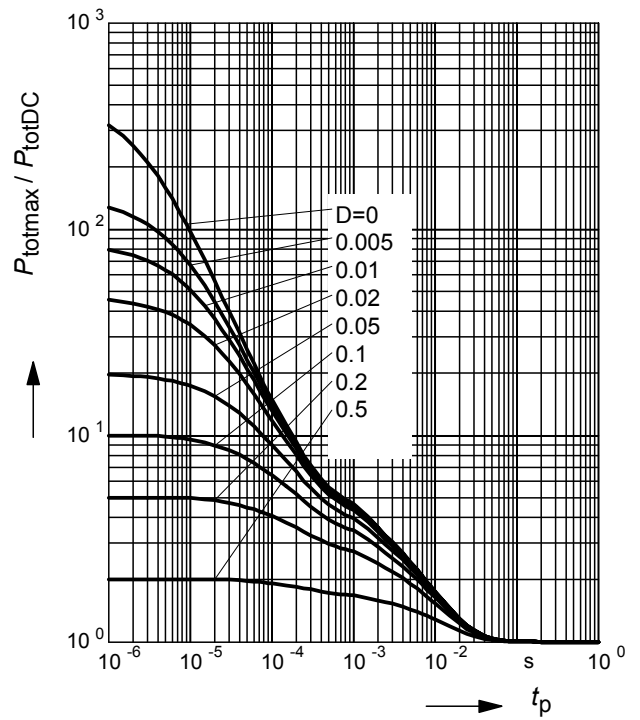

Package Outline

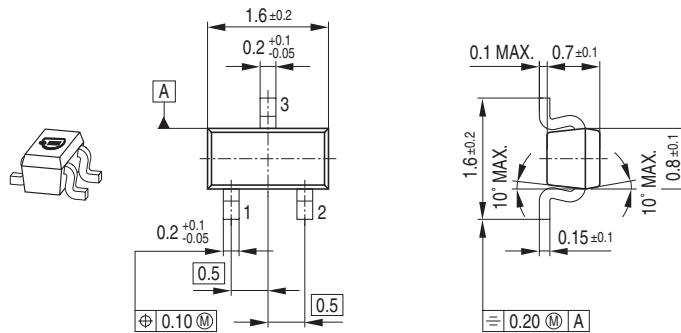

Foot Print

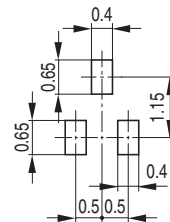

Marking Layout (Example)

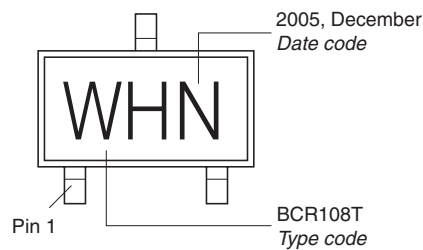

Standard Packing

Reel $\phi 180 \text{ mm} = 3.000 \text{ Pieces/Reel}$
 Reel $\phi 330 \text{ mm} = 10.000 \text{ Pieces/Reel}$

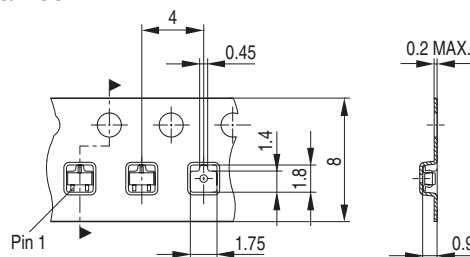

Date Code marking for discrete packages with one digit (SCD80, SC79, SC75¹⁾) CES-Code

Month	2003	2004	2005	2006	2007	2008	2009	2010	2011	2012	2013	2014
01	a	p	A	P	a	p	A	P	a	p	A	P
02	b	q	B	Q	b	q	B	Q	b	q	B	Q
03	c	r	C	R	c	r	C	R	c	r	C	R
04	d	s	D	S	d	s	D	S	d	s	D	S
05	e	t	E	T	e	t	E	T	e	t	E	T
06	f	u	F	U	f	u	F	U	f	u	F	U
07	g	v	G	V	g	v	G	V	g	v	G	V
08	h	x	H	X	h	x	H	X	h	x	H	X
09	j	y	J	Y	j	y	J	Y	j	y	J	Y
10	k	z	K	Z	k	z	K	Z	k	z	K	Z
11	l	2	L	4	l	2	L	4	l	2	L	4
12	n	3	N	5	n	3	N	5	n	3	N	5

1) New Marking Layout for SC75, implemented at October 2005.

Package Outline

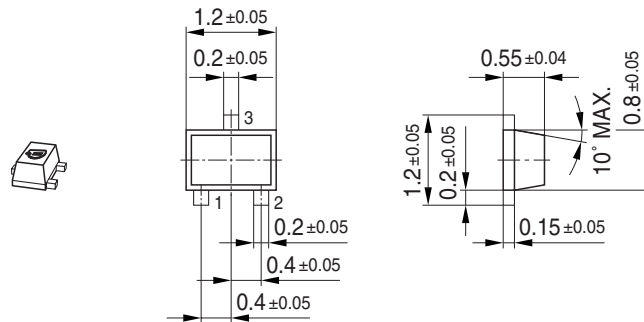

Foot Print

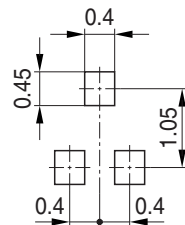

Marking Layout (Example)

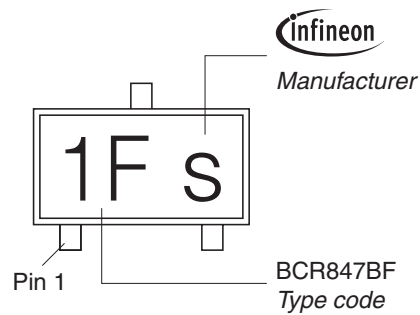

Standard Packing

Reel ø180 mm = 3.000 Pieces/Reel
 Reel ø330 mm = 10.000 Pieces/Reel

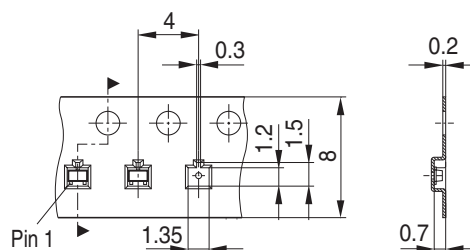

Package Outline

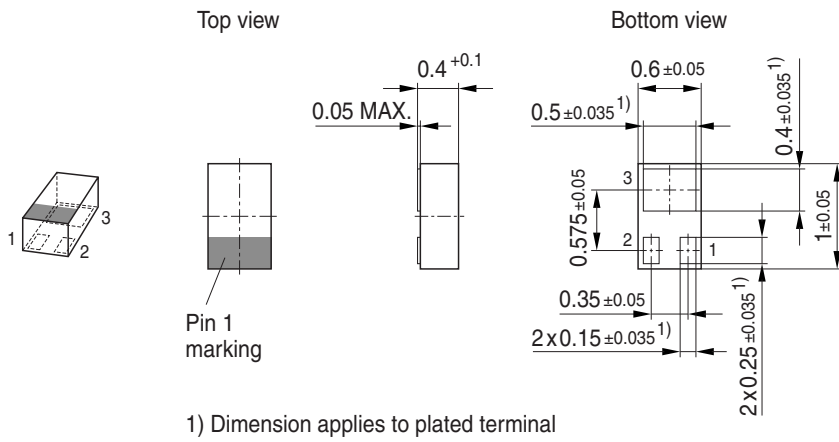

Foot Print

For board assembly information please refer to Infineon website "Packages"

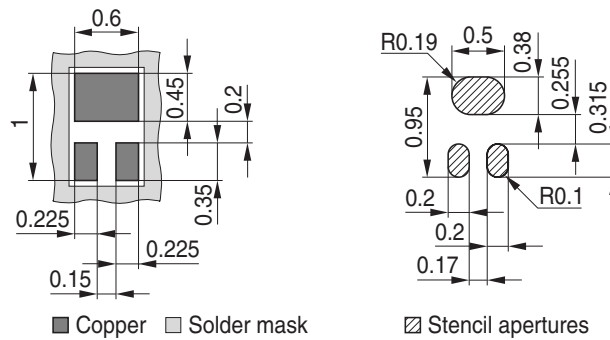

Marking Layout

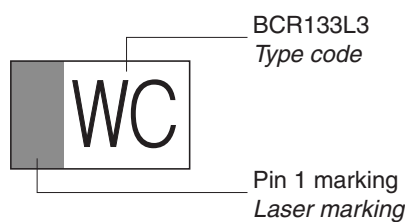

Standard Packing

Reel ø180 mm = 15.000 Pieces/Reel

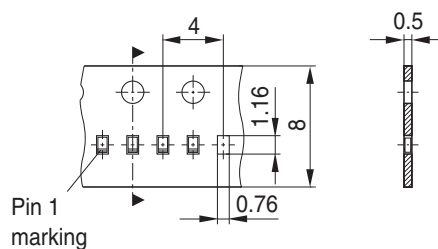

Edition 2006-02-01

Published by

Infineon Technologies AG

81726 München, Germany

© Infineon Technologies AG 2006.

All Rights Reserved.

Attention please!

The information given in this dokument shall in no event be regarded as a guarantee of conditions or characteristics ("Beschaffenheitsgarantie"). With respect to any examples or hints given herein, any typical values stated herein and/or any information regarding the application of the device, Infineon Technologies hereby disclaims any and all warranties and liabilities of any kind, including without limitation warranties of non-infringement of intellectual property rights of any third party.

Information

For further information on technology, delivery terms and conditions and prices please contact your nearest Infineon Technologies Office (www.infineon.com).

Warnings



Due to technical requirements components may contain dangerous substances. For information on the types in question please contact your nearest Infineon Technologies Office.

Infineon Technologies Components may only be used in life-support devices or systems with the express written approval of Infineon Technologies, if a failure of such components can reasonably be expected to cause the failure of that life-support device or system, or to affect the safety or effectiveness of that device or system.

Life support devices or systems are intended to be implanted in the human body, or to support and/or maintain and sustain and/or protect human life. If they fail, it is reasonable to assume that the health of the user or other persons may be endangered.

Looking for pricing, stock, or lifecycle information?

Click below to explore more details on WIN SOURCE:

-  [View BCR179F](#) on WIN SOURCE
-  [Infineon Technologies](#) Information

Optimize Your Supply Chain with WIN SOURCE Solutions

-  Global Sourcing Solution
-  Obsolete Management
-  Cost Control Management
-  Shortage Management
-  Alternative Solution
-  Excess Inventory Management