



**THE DATASHEET OF
BCR191E6327HTSA1**



PNP Silicon Digital Transistor

- Switching circuit, inverter, interface circuit, driver circuit
- Built in bias resistor ($R_1 = 22\text{ k}\Omega$, $R_2 = 22\text{ k}\Omega$)
- Pb-free (RoHS compliant) package
- Qualified according AEC Q101

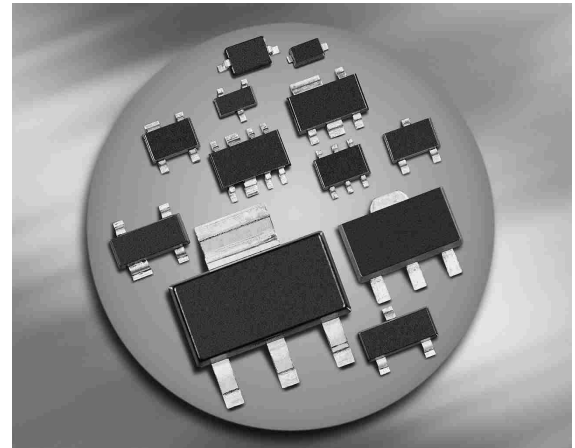
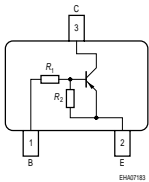
**BCR191
BCR191W**

| Type | Marking | Pin Configuration | | | | | | Package |
|---------|---------|-------------------|-----|-----|---|---|---|---------|
| BCR191 | W0s | 1=B | 2=E | 3=C | - | - | - | SOT23 |
| BCR191W | W0s | 1=B | 2=E | 3=C | - | - | - | SOT323 |

Maximum Ratings

| Parameter | Symbol | Value | Unit |
|---|--------------|-------------|------------------|
| Collector-emitter voltage | V_{CEO} | 50 | V |
| Collector-base voltage | V_{CBO} | 50 | |
| Input forward voltage | $V_{i(fwd)}$ | 60 | |
| Input reverse voltage | $V_{i(rev)}$ | 10 | |
| Collector current | I_C | 100 | mA |
| Total power dissipation- BCR191, $T_S \leq 102^\circ\text{C}$ BCR191W, $T_S \leq 124^\circ\text{C}$ | P_{tot} | 200 250 | mW |
| Junction temperature | T_j | 150 | $^\circ\text{C}$ |
| Storage temperature | T_{stg} | -65 ... 150 | |

Thermal Resistance

| Parameter | Symbol | Value | Unit |
|--|------------|-------|------|
| Junction - soldering point ¹⁾ | R_{thJS} | | K/W |
| BCR191 | | ≤ 240 | |
| BCR191W | | ≤ 105 | |

Electrical Characteristics at $T_A = 25^\circ\text{C}$, unless otherwise specified

| Parameter | Symbol | Values | | | Unit |
|-----------|--------|--------|------|------|------|
| | | min. | typ. | max. | |

DC Characteristics

| | | | | | |
|---|---------------|-----|----|-----|------------------|
| Collector-emitter breakdown voltage $I_C = 100 \mu\text{A}, I_B = 0$ | $V_{(BR)CEO}$ | 50 | - | - | V |
| Collector-base breakdown voltage $I_C = 10 \mu\text{A}, I_E = 0$ | $V_{(BR)CBO}$ | 50 | - | - | |
| Collector-base cutoff current $V_{CB} = 40 \text{ V}, I_E = 0$ | I_{CBO} | - | - | 100 | nA |
| Emitter-base cutoff current $V_{EB} = 10 \text{ V}, I_C = 0$ | I_{EBO} | - | - | 350 | μA |
| DC current gain ²⁾ $I_C = 5 \text{ mA}, V_{CE} = 5 \text{ V}$ | h_{FE} | 50 | - | - | - |
| Collector-emitter saturation voltage ²⁾ $I_C = 10 \text{ mA}, I_B = 0.5 \text{ mA}$ | V_{CEsat} | - | - | 0.3 | V |
| Input off voltage $I_C = 100 \mu\text{A}, V_{CE} = 5 \text{ V}$ | $V_{i(off)}$ | 0.8 | - | 1.5 | |
| Input on voltage $I_C = 2 \text{ mA}, V_{CE} = 0.3 \text{ V}$ | $V_{i(on)}$ | 1 | - | 2.5 | |
| Input resistor | R_1 | 15 | 22 | 29 | $\text{k}\Omega$ |
| Resistor ratio | R_1/R_2 | 0.9 | 1 | 1.1 | - |

AC Characteristics

| | | | | | |
|--|----------|---|-----|---|-----|
| Transition frequency $I_C = 10 \text{ mA}, V_{CE} = 5 \text{ V}, f = 100 \text{ MHz}$ | f_T | - | 200 | - | MHz |
| Collector-base capacitance $V_{CB} = 10 \text{ V}, f = 1 \text{ MHz}$ | C_{cb} | - | 3 | - | pF |

¹⁾For calculation of R_{thJA} please refer to Application Note AN077 (Thermal Resistance Calculation)

²⁾Pulse test: $t < 300 \mu\text{s}; D < 2\%$

DC current gain $h_{FE} = f(I_C)$

$V_{CE} = 5\text{ V}$ (common emitter configuration)

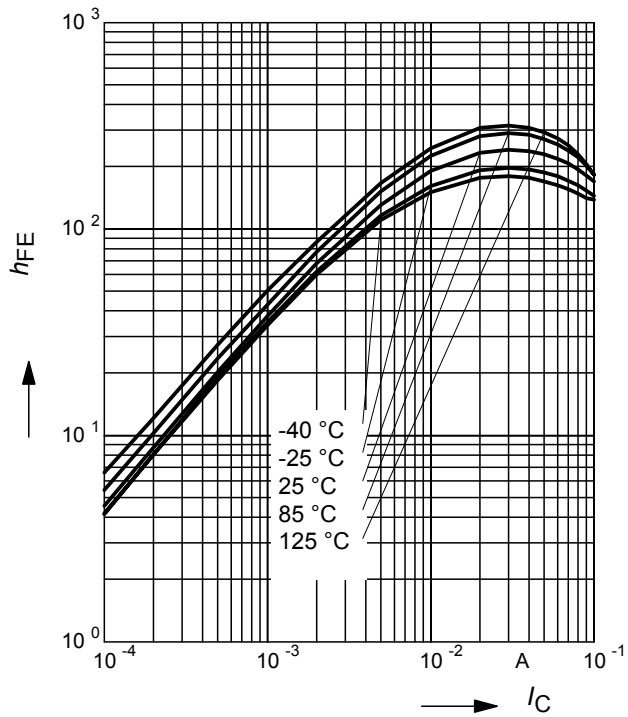

Collector-emitter saturation voltage

$V_{CEsat} = f(I_C), I_C/I_B = 20$

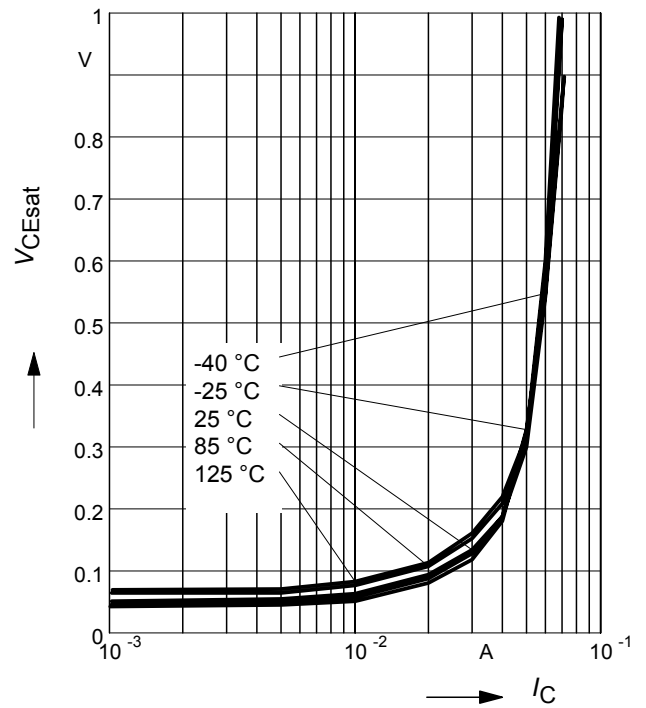

Input on Voltage $V_{i(on)} = f(I_C)$

$V_{CE} = 0.3\text{ V}$ (common emitter configuration)

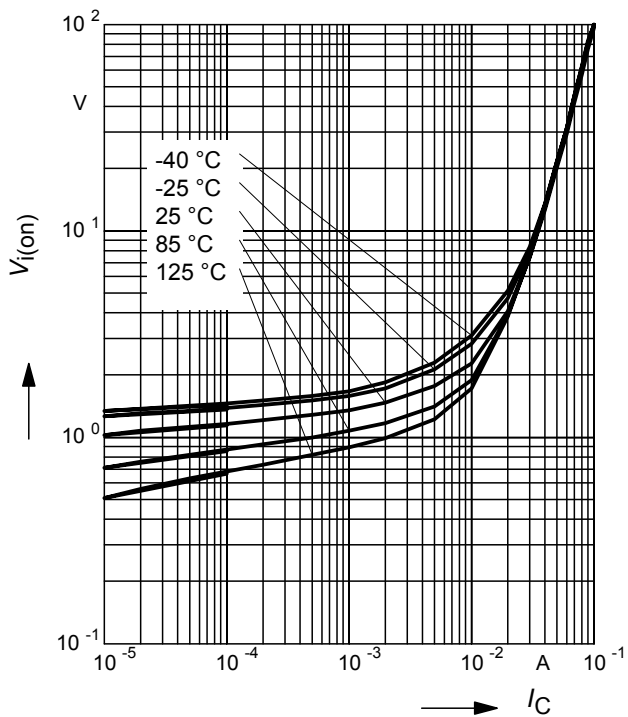

Input off voltage $V_{i(off)} = f(I_C)$

$V_{CE} = 5\text{ V}$ (common emitter configuration)

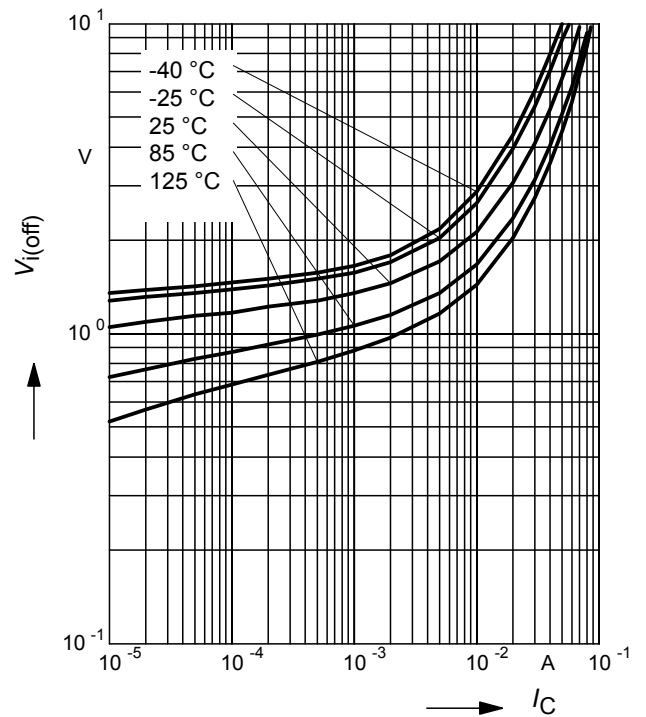

Total power dissipation $P_{tot} = f(T_S)$

BCR191

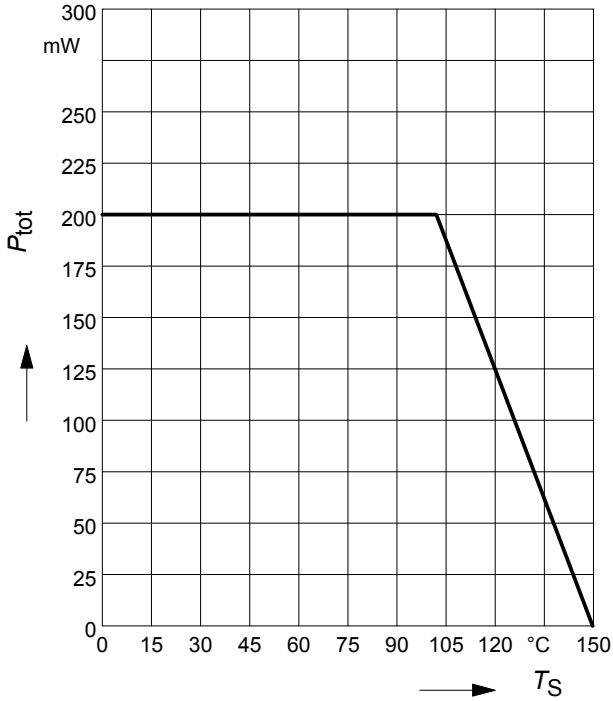

Total power dissipation $P_{tot} = f(T_S)$

BCR191W

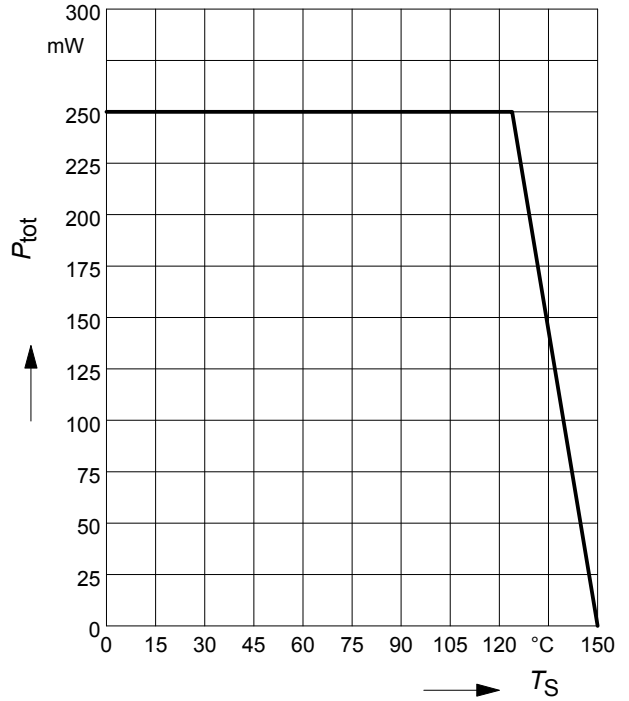

Permissible Pulse Load $R_{thJS} = f(t_p)$

BCR191

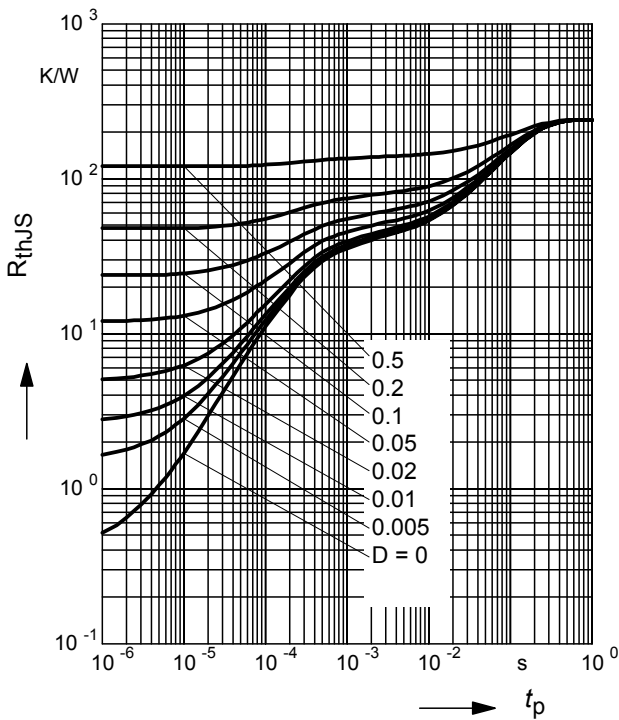

Permissible Pulse Load

$P_{totmax}/P_{totDC} = f(t_p)$

BCR191

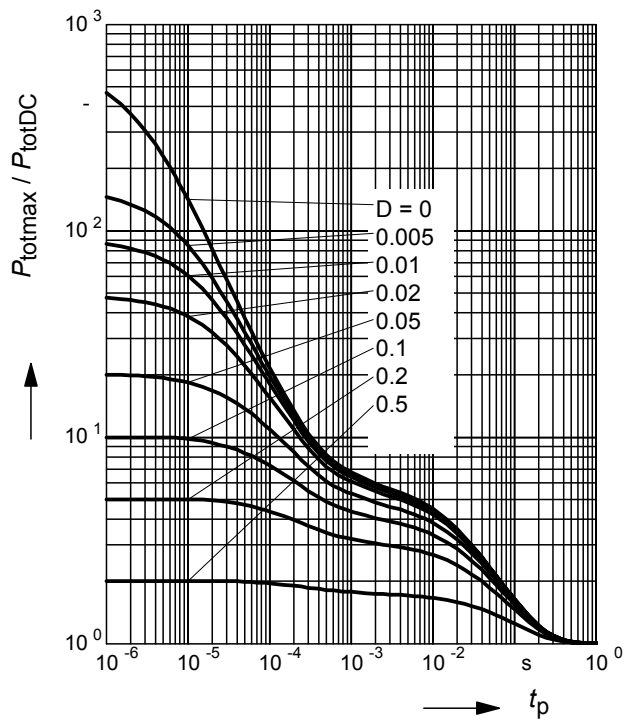

Permissible Puls Load $R_{thJS} = f(t_p)$

BCR191W

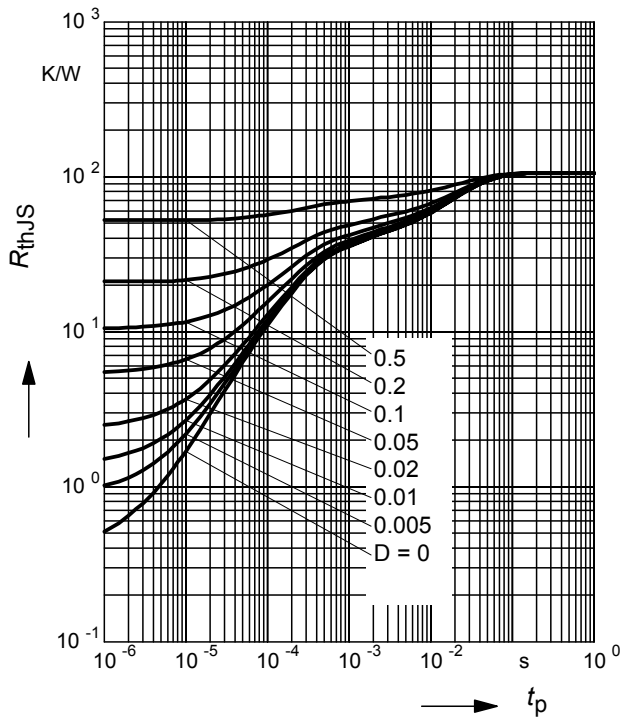

Permissible Pulse Load

$P_{totmax}/P_{totDC} = f(t_p)$

BCR191W

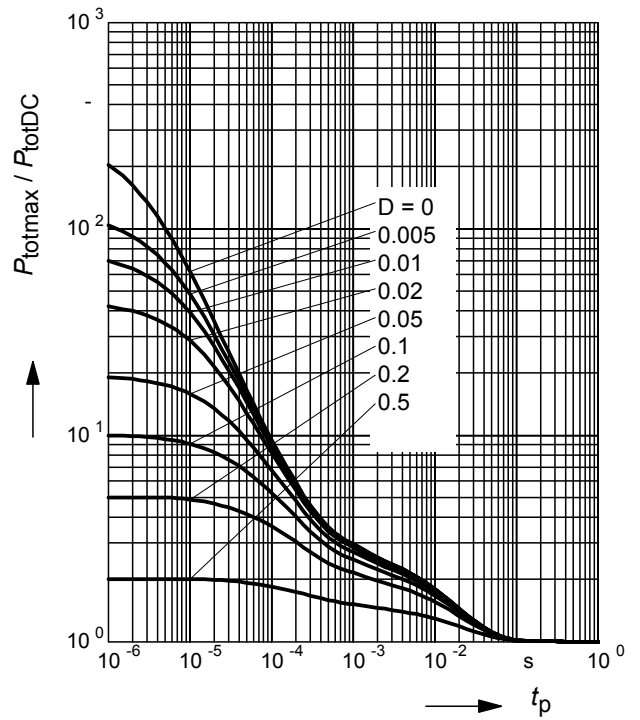

Package Outline



1) Lead width can be 0.6 max. in dambar area

Foot Print

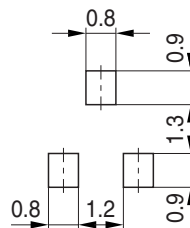

Marking Layout (Example)

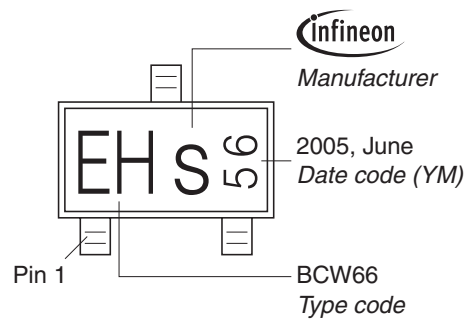

Standard Packing

Reel \varnothing 180 mm = 3.000 Pieces/Reel
 Reel \varnothing 330 mm = 10.000 Pieces/Reel

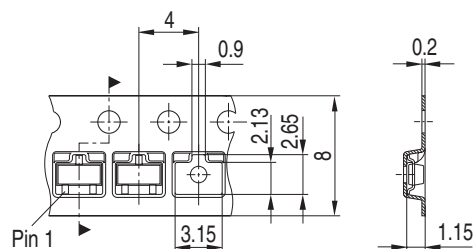

Package Outline

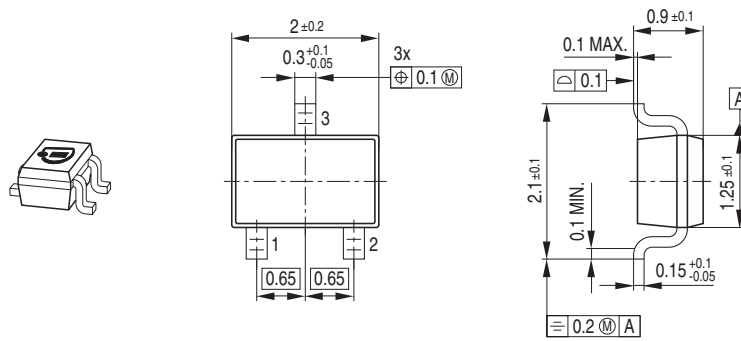

Foot Print

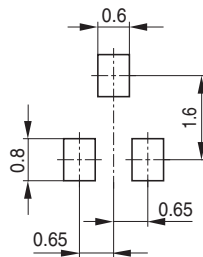

Marking Layout (Example)

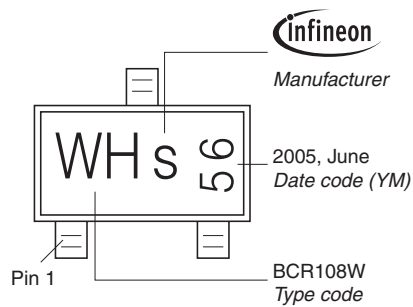

Standard Packing

Reel $\varnothing 180$ mm = 3.000 Pieces/Reel
 Reel $\varnothing 330$ mm = 10.000 Pieces/Reel

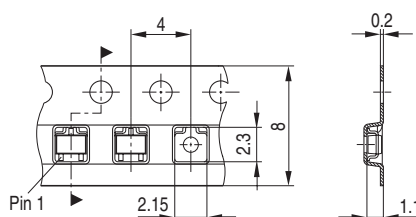

Edition 2009-11-16

**Published by
Infineon Technologies AG
81726 Munich, Germany**

**© 2009 Infineon Technologies AG
All Rights Reserved.**

Legal Disclaimer

The information given in this document shall in no event be regarded as a guarantee of conditions or characteristics. With respect to any examples or hints given herein, any typical values stated herein and/or any information regarding the application of the device, Infineon Technologies hereby disclaims any and all warranties and liabilities of any kind, including without limitation, warranties of non-infringement of intellectual property rights of any third party.

Information

For further information on technology, delivery terms and conditions and prices, please contact the nearest Infineon Technologies Office ([<www.infineon.com>](http://www.infineon.com)).



Warnings

Due to technical requirements, components may contain dangerous substances. For information on the types in question, please contact the nearest Infineon Technologies Office.

Infineon Technologies components may be used in life-support devices or systems only with the express written approval of Infineon Technologies, if a failure of such components can reasonably be expected to cause the failure of that life-support device or system or to affect the safety or effectiveness of that device or system. Life support devices or systems are intended to be implanted in the human body or to support and/or maintain and sustain and/or protect human life. If they fail, it is reasonable to assume that the health of the user or other persons may be endangered.

Looking for pricing, stock, or lifecycle information?

Click below to explore more details on WIN SOURCE:

-  [View BCR191E6327HTSA1 on WIN SOURCE](#)
-  [Infineon Technologies](#) Information

Optimize Your Supply Chain with WIN SOURCE Solutions

-  Global Sourcing Solution
-  Obsolete Management
-  Cost Control Management
-  Shortage Management
-  Alternative Solution
-  Excess Inventory Management