

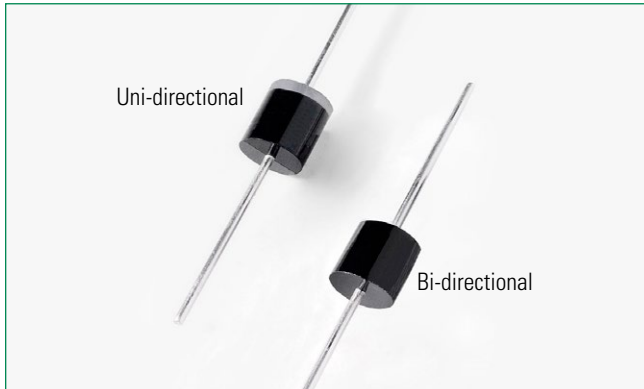



**THE DATASHEET OF
30KPA30A**



30KPA Series



Agency Approvals

Agency	Agency File Number
	E230531

Maximum Ratings and Thermal Characteristics ($T_A = 25^\circ\text{C}$ unless otherwise noted)

Parameter	Symbol	Value	Unit
Peak Pulse Power Dissipation by 10/1000 μs Test Waveform (Fig.2)(Note 1)	P_{PPM}	30	kW
Steady State Power Dissipation on Infinite Heat Sink at $T_L = 75^\circ\text{C}$	P_D	8.0	W
Peak Forward Surge Current, 8.3ms Single Half Sine Wave Unidirectional Only (Note 2)	I_{FSM}	400	A
Operating Junction and Storage Temperature Range	T_J, T_{STG}	-55 to 175	$^\circ\text{C}$
Typical Thermal Resistance Junction to Lead	$R_{\theta JL}$	8.0	$^\circ\text{C/W}$
Typical Thermal Resistance Junction to Ambient	$R_{\theta JA}$	40	$^\circ\text{C/W}$

Notes:

1. Non-repetitive current pulse, per Fig. 4 and derated above T_J (initial) $= 25^\circ\text{C}$ per Fig. 3.
2. Measured on 8.3ms single half sine wave or equivalent square wave, duty cycle=4 per minute maximum.

Functional Diagram

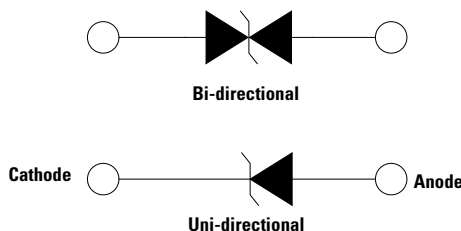

Descriptions

The 30KPA Series is designed specifically to protect sensitive electronic equipment from voltage transients induced by lightning and other transient voltage events.

Features

- 30kW peak pulse capability at 10/1000 μs waveform, repetition rate (duty cycles):0.01%
- Glass passivated chip junction in P600 package
- Fast response time: typically less than 1.0ps from 0 Volts to BV min
- Excellent clamping capability
- Typical failure mode is short from over-specified voltage or current
- Whisker test is conducted based on JEDEC JESD201A per its table 4a and 4c
- IEC-61000-4-2 ESD 30kV(Air), 30kV (Contact)
- ESD protection of data lines in accordance with IEC 61000-4-2
- EFT protection of data lines in accordance with IEC 61000-4-4
- Low incremental surge resistance
- Typical I_R less than $2\mu\text{A}$ when V_{BR} min > 73V
- High temperature to reflow soldering guaranteed: $260^\circ\text{C}/40\text{sec} / 0.375''$ (9.5mm) lead length, 5 lbs., (2.3kg) tension
- $V_{BR} @ T_J = V_{BR} @ 25^\circ\text{C} \times (1 + \alpha T \times (T_J - 25))$ (α T: Temperature Coefficient, typical value is 0.1%)
- UL Recognized epoxy meeting flammability rating V-0
- Matte tin lead-free plated
- Halogen free and RoHS compliant
- Pb-free E3 means 2nd level interconnect is Pb-free and the terminal finish material is tin(Sn) (IPC/ JEDEC J-STD-609A.01)

Applications

TVS components are ideal for the protection of I/O interfaces, V_{CC} bus and other vulnerable circuits used in telecom, computer, industrial and consumer electronic applications.

Additional Information



Datasheet



Resources



Samples

Electrical Characteristics (T_A=25°C unless otherwise noted)

Part Number (Uni)	Part Number (Bi)	Reverse Stand-off Voltage V _R (Volts)	Breakdown Voltage V _{BR} (Volts) @ I _T		Test Current I _T (mA)	Maximum Peak Pulse Current I _{PP} (A)	Maximum Reverse Leakage I _R @V _R (μA)	Maximum Clamping Voltage V _C @ I _{PP} (V)	Agency Recognition 
			Min.	Max.					
30KPA28A	30KPA28CA	28	31.28	34.41	50	606.0	5000	50.0	X
30KPA30A	30KPA30CA	30	33.51	36.86	50	548.9	5000	55.2	X
30KPA33A	30KPA33CA	33	36.90	40.59	50	517.9	5000	58.5	X
30KPA36A	30KPA36CA	36	40.20	44.22	50	490.3	5000	61.8	X
30KPA39A	30KPA39CA	39	43.60	47.96	20	450.9	2000	67.2	X
30KPA42A	30KPA42CA	42	46.90	51.59	10	420.8	1000	72.0	X
30KPA43A	30KPA43CA	43	48.00	52.80	10	415.1	1000	73.0	X
30KPA45A	30KPA45CA	45	50.30	55.33	5	391.5	250	77.4	X
30KPA48A	30KPA48CA	48	53.60	58.96	5	371.3	150	81.6	X
30KPA51A	30KPA51CA	51	57.00	62.70	5	350.7	50	86.4	X
30KPA54A	30KPA54CA	54	60.30	66.33	5	331.5	20	91.4	X
30KPA58A	30KPA58CA	58	64.80	71.28	5	327.9	20	92.4	X
30KPA60A	30KPA60CA	60	67.00	73.70	5	297.1	15	102.0	X
30KPA64A	30KPA64CA	64	71.50	78.65	5	291.3	10	104.0	X
30KPA66A	30KPA66CA	66	73.70	81.07	5	283.2	2	107.0	X
30KPA70A	30KPA70CA	70	78.20	86.02	5	278.0	2	109.0	X
30KPA71A	30KPA71CA	71	79.30	87.23	5	271.7	2	111.5	X
30KPA72A	30KPA72CA	72	80.40	88.44	5	265.8	2	114.0	X
30KPA75A	30KPA75CA	75	83.80	92.18	5	253.8	2	119.4	X
30KPA78A	30KPA78CA	78	87.10	95.81	5	234.9	2	129.0	X
30KPA84A	30KPA84CA	84	93.80	103.18	5	217.7	2	139.2	X
30KPA90A	30KPA90CA	90	100.50	110.55	5	207.0	2	146.4	X
30KPA96A	30KPA96CA	96	107.20	117.92	5	194.2	2	156.0	X
30KPA102A	30KPA102CA	102	113.90	125.29	5	183.0	2	165.6	X
30KPA108A	30KPA108CA	108	120.60	132.66	5	172.9	2	175.2	X
30KPA120A	30KPA120CA	120	134.00	147.40	5	155.9	2	194.4	X
30KPA132A	30KPA132CA	132	147.40	162.14	5	142.3	2	213.0	X
30KPA144A	30KPA144CA	144	160.80	176.88	5	135.8	2	223.2	X
30KPA150A	30KPA150CA	150	167.60	184.36	5	129.8	2	233.4	X
30KPA156A	30KPA156CA	156	174.30	191.73	5	123.7	2	245.0	X
30KPA160A	30KPA160CA	160	178.70	196.57	5	120.0	2	252.6	X
30KPA168A	30KPA168CA	168	187.70	206.47	5	111.2	2	272.4	X
30KPA170A	30KPA170CA	170	189.90	208.89	5	110.2	2	275.0	X
30KPA180A	30KPA180CA	180	201.10	221.21	5	104.3	2	290.4	X
30KPA198A	30KPA198CA	198	221.20	243.32	5	94.7	2	319.8	X
30KPA216A	30KPA216CA	216	241.30	265.43	5	86.9	2	348.6	X
30KPA240A	30KPA240CA	240	268.10	294.91	5	78.3	2	387.0	X
30KPA258A	30KPA258CA	258	288.20	317.02	5	72.8	2	416.4	X
30KPA260A	30KPA260CA	260	290.40	319.44	5	72.8	2	416.0	X
30KPA270A	30KPA270CA	270	301.60	331.76	5	69.5	2	436.2	X
30KPA280A	30KPA280CA	280	312.80	344.08	5	65.3	2	464.0	X
30KPA288A	30KPA288CA	288	321.70	353.87	5	64.5	2	469.9	X
30KPA300A	30KPA300CA	300	334.00	367.40	5	62.0	2	484.0	X
30KPA320A	30KPA320CA	320	357.40	391.40	5	57.2	2	530.0	-
30KPA350A	30KPA350CA	350	391.00	428.10	5	53.4	2	567.0	-
30KPA360A	30KPA360CA	360	402.10	440.30	5	47.3	2	640.0	-

For bidirectional type having V_{RWM} of 60 volts and less, the I_R limit is double.

For parts without A, the V_{BR} is ± 10% and V_C is 5% higher than with A parts, the parts without A are currently available, but not recommended for new designs. The parts with A are preferred.

I-V Curve Characteristics

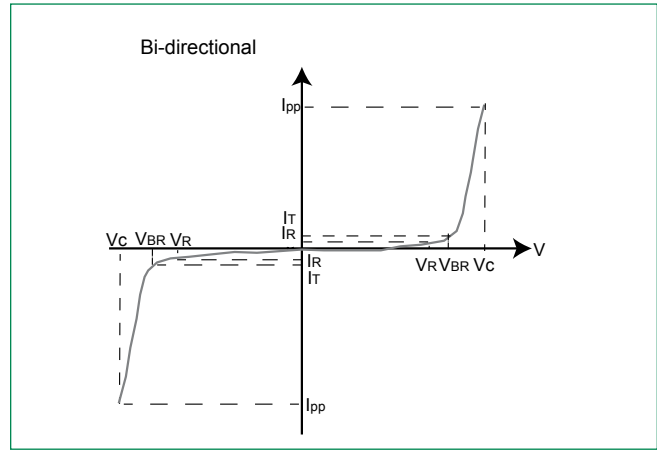
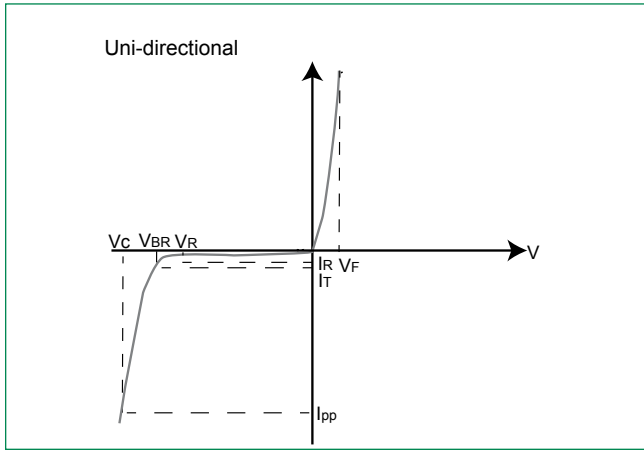

- P_{PPM} Peak Pulse Power Dissipation** – Max power dissipation
- V_R Stand-off Voltage** – Maximum voltage that can be applied to the TVS without operation
- V_{BR} Breakdown Voltage** – Maximum voltage that flows through the TVS at a specified test current (I_T)
- V_C Clamping Voltage** – Peak voltage measured across the TVS at a specified I_{ppm} (peak impulse current)
- I_R Reverse Leakage Current** – Current measured at V_R
- V_F Forward Voltage Drop for Uni-directional**

Ratings and Characteristic Curves ($T_A=25^\circ\text{C}$ unless otherwise noted)

Figure 1 - TVS Transients Clamping Waveform

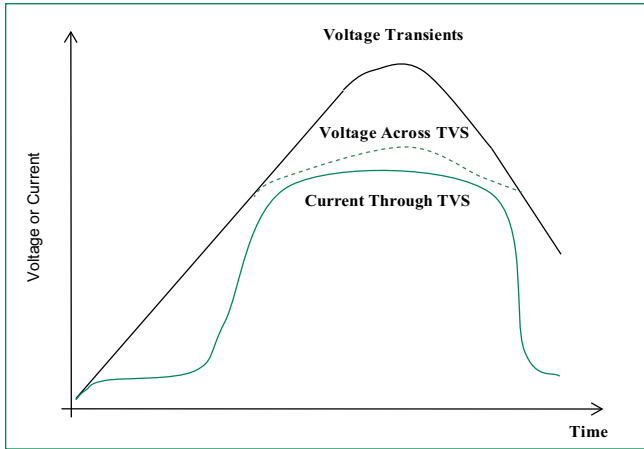
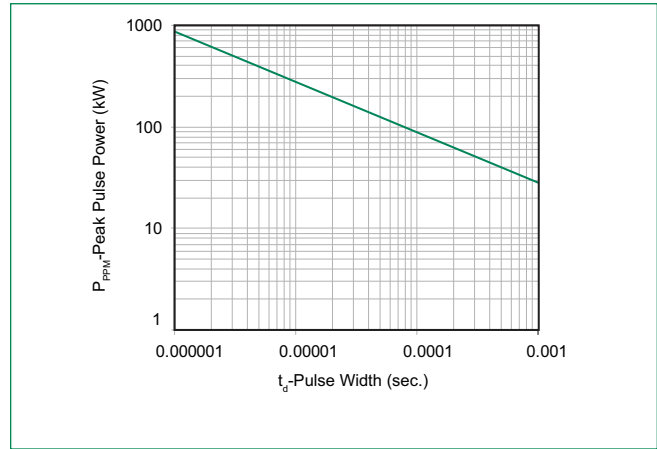

Figure 2 - Peak Pulse Power Rating Curve



Ratings and Characteristic Curves ($T_A=25^\circ\text{C}$ unless otherwise noted) (Continued)

Figure 3 - Peak Pulse Power Derating Curve

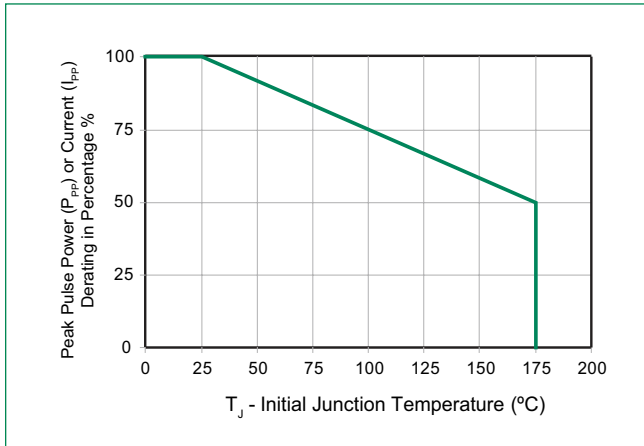

Figure 4 - Pulse Waveform

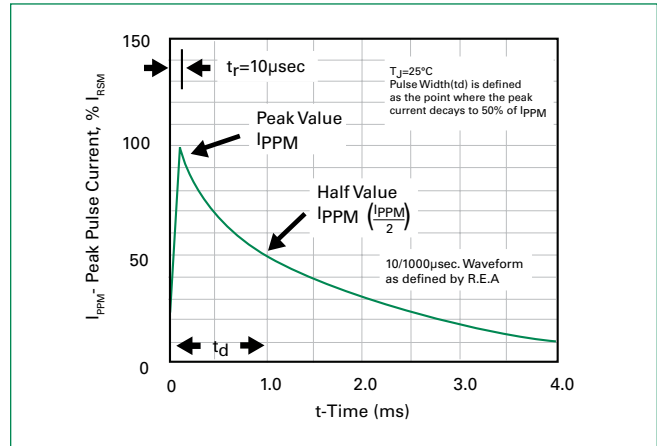

Figure 5 - Typical Junction Capacitance

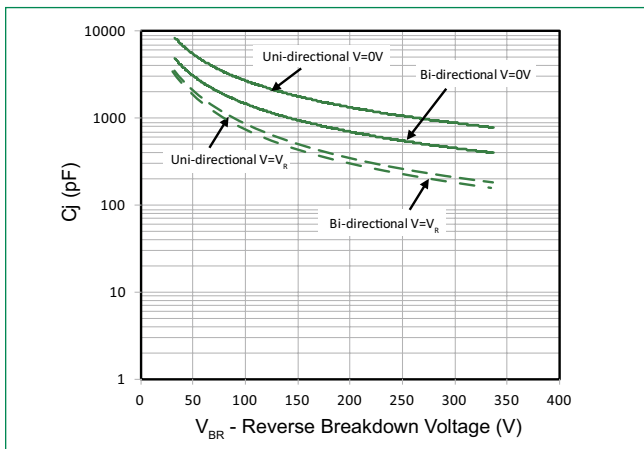

Figure 6 - Typical Transient Thermal Impedance

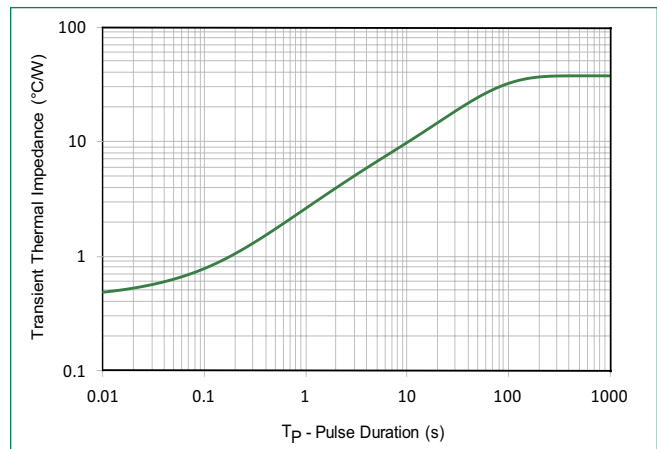

Figure 7 - Maximum Non-Repetitive Peak Forward Surge Current Uni-Directional Only

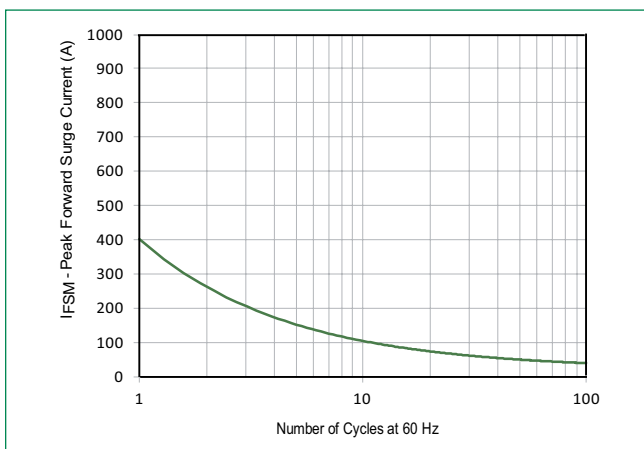
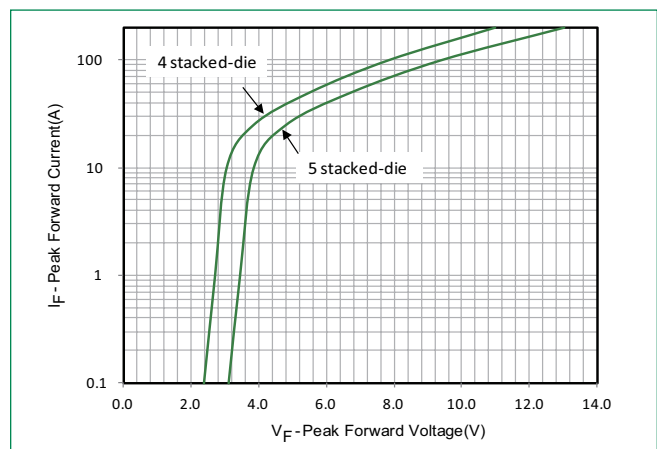

Figure 8 - Peak Forward Voltage Drop vs Peak Forward Current (Typical Values)



Soldering Parameters

Reflow Condition		Lead-free assembly
Pre Heat	- Temperature Min ($T_{s(min)}$)	150°C
	- Temperature Max ($T_{s(max)}$)	200°C
	- Time (min to max) (t_s)	60 – 180 secs
Average ramp up rate (Liquidus Temp (T_A) to peak		3°C/second max
$T_{s(max)}$ to T_A - Ramp-up Rate		3°C/second max
Reflow	- Temperature (T_A) (Liquidus)	217°C
	- Time (min to max) (t_s)	60 – 150 seconds
Peak Temperature (T_p)		260 ^{+0/-5} °C
Time within 5°C of actual peak Temperature (t_p)		20 – 40 seconds
Ramp-down Rate		6°C/second max
Time 25°C to peak Temperature (T_p)		8 minutes Max.
Do not exceed		260°C



Flow/Wave Soldering (Solder Dipping)

Peak Temperature :	265°C
Dipping Time :	10 seconds
Soldering :	1 time

Physical Specifications

Weight	0.07oz., 2.5g
Case	P600 molded plastic body over passivated junction.
Polarity	Color band denotes the cathode except Bipolar.
Terminal	Matte Tin axial leads, solderable per JESD22-B102.

Environmental Specifications

High Temp. Storage	JESD22-A103
HTRB	JESD22-A108
Temperature Cycling	JESD22-A104
H3TRB	JESD22-A101
RSH	JESD22-B106

Dimensions

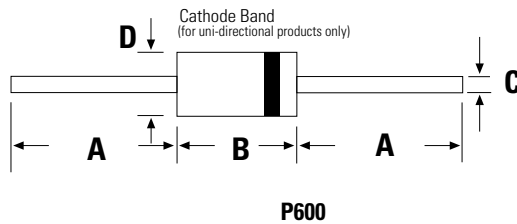

Dimensions	Inches		Millimeters	
	Min	Max	Min	Max
A	1.000	-	25.40	-
B	0.340	0.360	8.60	9.10
C	0.048	0.054	1.22	1.36
D	0.340	0.360	8.60	9.10

Part Numbering System

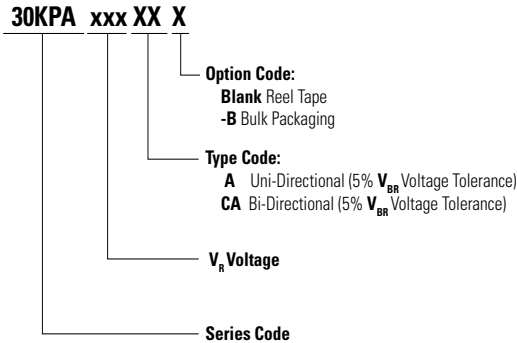

Part Marking System

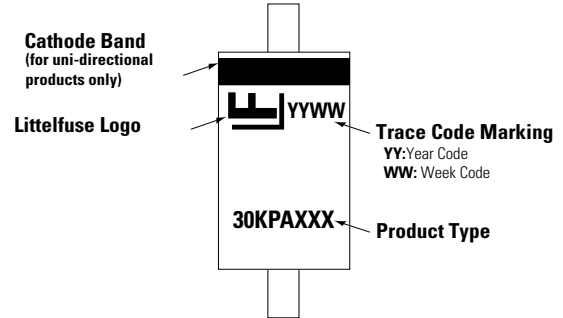

Packing Options

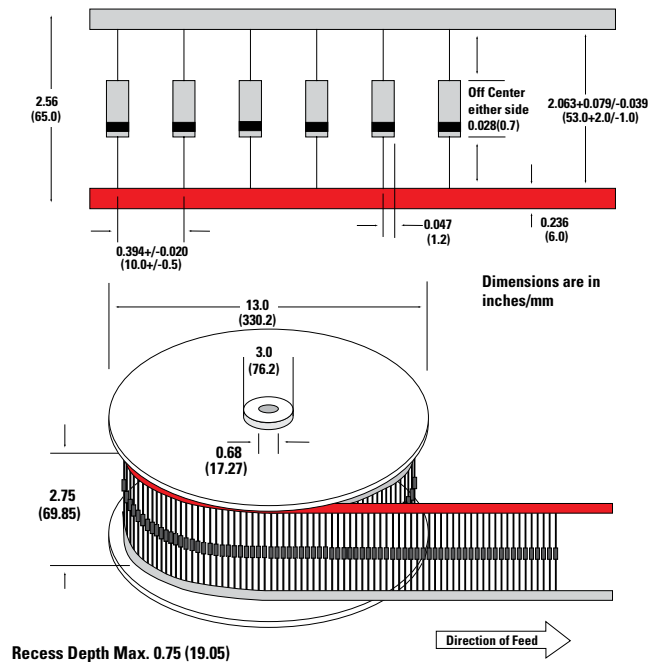

Part Number	Component Package	Quantity	Packaging Option	Packaging Specification
30KPAxxxXX	P600	800	Tape & Reel	EIA STD RS-296
30KPAxxxXX-B	P600	100	Bulk	Littelfuse Spec.

Tape and Reel Specification



Looking for pricing, stock, or lifecycle information?

Click below to explore more details on WIN SOURCE:

-  [View 30KPA30A on WIN SOURCE](#)
-  [Littelfuse Inc. Information](#)

Optimize Your Supply Chain with WIN SOURCE Solutions

-  Global Sourcing Solution
-  Obsolete Management
-  Cost Control Management
-  Shortage Management
-  Alternative Solution
-  Excess Inventory Management