



THE DATASHEET OF
784774222



Q+products



Ferrite Beads
Axial EMI Suppression Ferrites
SMD Power Inductors

Q+products

Benefits

Q+products have given rise to plenty of discussions since their launch.

The most frequently asked questions: What advantage do these products give us?

To whom may I sell them? And for which applications are they suitable?

1

Optimized construction

Internal structures of the products in the Q+products portfolio are very different from conventional ones. For example, the wire connection between coil wire and component is not made with a conventional solder joint, but by means of a welding process. Another example is ferrite sleeves; compared with the conventional industry article, the surface form is optimized and this considerably simplifies the routing of lines.



2

AEC-Q 200 qualification

All Q+products are qualified in accordance with the AEC-Q 200. The Automotive Electronics Council Qualification (AECQ) does not reflect the qualification standard of the automotive industry in all cases, but describes product quality very precisely only by means of a variety of reliability checks.



3

Higher level of automation

Automation vs. partial automation / manual process

Increasing the degree of automation in the manufacturing process changes the variance of process parameters positively by eliminating the influence of the operator. This also ensures even more effective process controlling.

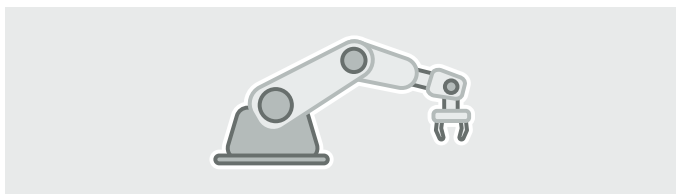

4

High process capability level

Process capability is determined by means of familiar statistics and describes the stability of a manufacturing process. A statistical evaluation by itself will not make a manufacturing process more stable, however. This also depends on the added values of other Q+products.

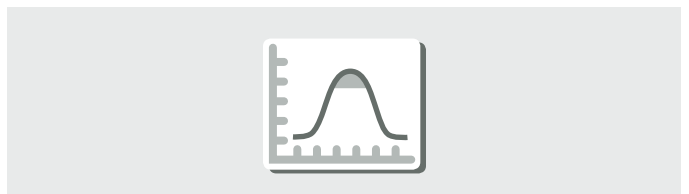

Q+products Benefits



5 Additional quality controls

Additional quality controls are geared specifically to the familiar, critical quality features of the individual Q+products. These features are directly monitored, documented and qualified according to their requirements in the appropriate manufacturing step.



6 Production on strictly defined production lines

Additional quality controls can be carried out efficiently only if they are used for previously evaluated production lines. Even two identical manufacturing processes can have different results. So process-based influences are difficult to generalize, which is why we specially select and monitor the production lines.



7 Extended temperature range

The market requires tough products. So we have already extended the temperature range of Q+products ferrite sleeves to -55°C / $+150^{\circ}\text{C}$. We also aim to extend such increases in temperature range to include all Q+products.

Temperature range up to $+150^{\circ}\text{C}$



Q+products

Qualification Standard

The qualification standard refers to the AEC-Q 200 and is performed for all products which are shown in this catalogue. For your reference, you can find in the following table a short summary of the performed tests for inductors/transformers.

High Temperature Exposure

Storage for 1000 hours to at rated operating temperature (according to the datasheet)

Temperature Cycling

1000 cycles at operating temperature (according to the datasheet, e.g. -40 °C / +125 °C). with an maximum dwell time of one minute.

Biased Humidity

1000 hours at 85 °C and 85 % RH without electrical stress

Operational Life

1000 hours at operating temperature minus self-heating temperature under electrical stress (rated current)

External Visual

Inspection of the device looking/construction, workmanship and marking.

Physical Dimension

The mechanical dimension have to be in between the specification

Terminal Strength (SMD)

The parts will be stressed with a pull of force of 17.7 Newton for 60 seconds. The focus is on the soldering joint.

Resistance to Solvents

Three different kinds of solvent do not have any impact to the device construction, marking and looking.

Mechanical Shock

Mechanical shocks shall not have any impact to the device construction or function. These shocks will be simulated 18 times, by a amplitude of 100 g's for 6 milliseconds.

Vibration

Vibrations of 10 g's in a frequency range from 15 up to 2000 Hz for 20 minutes shall not have any impact to the construction of the device. This process will be done in 12 cycles for each of the Axis.

Resistance to Soldering Heat

A Reflow Oven Test for five times shall not have any impact to the device

ESD

An Electrostatic discharge of 6 kV with direct contact, 12 kV, 16 kV and 25 kV with air contact shall not have any impact to the device.

Solderability

Three different Soldering procedures will be gone through. In each case an impact to the device and construction isn't allowed.

Electrical Characterization

Parametrically test which shows in a summary the min, max, man and standard deviation at room temperature as well as at min and max operating temperature.

Board Flex

At surface mounted devices, an impact due to bending, flexing and pulling forces shall be not be given.



Q+products Standards by Comparison



Although it might seem much better at the first sight, it doesn't mean, that the industrial parts are less qualified than the Q+ Products. The difference in here is the higher reliable requirements which we going to prove accordance to the AEC-Q 200. To show the difference, the following table contrasts some main parts out of the industrial qualification standard of Würth Elektronik eiSos with the main necessary qualification standards out of the AEC-Q 200.

Test description	Industrial Standard	Q+products Standard
High Temperature Exposure	500 hours	1000 hours
Temperature Cycling	500 cycles	1000 cycles
Biased Humidity	-	1000 hours
Moisture Resistance	500 hours	-
Operational Life	1000 hours	1000 hours
External Visual	✓	✓
Physical Dimension	-	✓
Terminal strength	✓	✓
Resistance to solvent	-	3 different Solvents
Mechanical Shock	-	✓
Vibration	✓	✓
Resistance to Soldering Heat	5 time Reflow	5 time Reflow
ESD	-	✓
Solderability	✓	✓
Electrical Characterization	-	✓
Board Flex	✓	✓
Low Temperature Exposure	✓	-

Legend to the table:

- ✓ both of the tests are the same
- not tested



Waldenburg (Germany)



Shenyang (China)

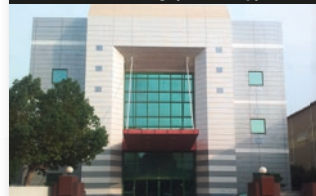

Taichung (Taiwan)



Longgang (China)



Seoul (Korea)

Production Site
Quality & Design Center

WE-CBA

SMD EMI Suppression Ferrite Bead

Size 0402



Characteristics

- Reliable Ni-Sn electrodes
- High rated current up to 5A
- Recommended soldering: Reflow
- Operating temperature: -55 °C to +125 °C

Applications

- Perfect as data lined filter and for uncoupling of distribution voltage

Type definition of SMD ferrites WE-CBA

The special SMD chip bead ferrites can be put directly on the printed circuit board. They offer excellent anti-EMI properties and low DC-resistance. Placed very close next to the interference source even with smallest size 0402, maximal impedance at 1000 Ω can be reached.

High Speed:

"High Speed" SMD ferrites WE-CBA have lower impedance in the lower frequency ranges thus they have only a low attenuation for fast signals.

Application e.g. USB 2.0, IEEE 1394, LVDS

Wide Band:

"Wide Band" SMD ferrites WE-CBA already show high impedance in low frequency range. Therefore they are wide band through the whole spectrum.

Application e.g. control signals, RS232, RS422, DC/DC converter

High Current:

"High Current" SMD ferrites WE-CBA are designed for high current (over 1 A). The rated current refers to 40 K self-heating.

High current SMD ferrites are available in all three types (High Speed, Wide Band and High Frequency).

Application e.g. power supply, DC/DC converter

Advice: Pay attention for the use of SMD ferrites for high rated current >1 A and ambient temperature over +85 °C that the rated current has to be reduced when temperature is above +85 °C (Derating).

The characteristic line in the right figure shows, that e.g. at +100 °C ambient temperature the maximal rated current has to add up to only 60 % of the data sheet value, without an overload of the component.

Derating +85 °C



Derating +105 °C



Electrical properties

Order Code	Z @ 100 MHz (Ω)	Z _{max} (Ω)	Testcondition Z _{max} (MHz)	I _R (mA)	R _{DC} (Ω)	Type of Application
782 422 101	100	180	500	500	0.30	Wide Band
782 422 221	220	330	400	400	0.30	Wide Band
782 422 331	330	640	300	300	0.50	Wide Band
782 422 511	510	730	300	200	0.80	Wide Band
782 422 601	600	800	300	200	0.80	Wide Band
782 422 102	1000	1200	170	200	1.00	Wide Band
782 423 100	10	17	700	1500	0.03	High Current
782 423 700	70	140	600	1000	0.09	High Current

Land pattern (in mm)

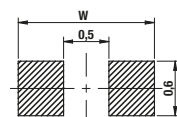

WIDE BAND: W = 1,5
HIGH CURRENT: W = 2,2

Dimensions (in mm)



WE-CBA

SMD EMI Suppression Ferrite Bead

Size 0402



Typical impedance characteristics Wide Band

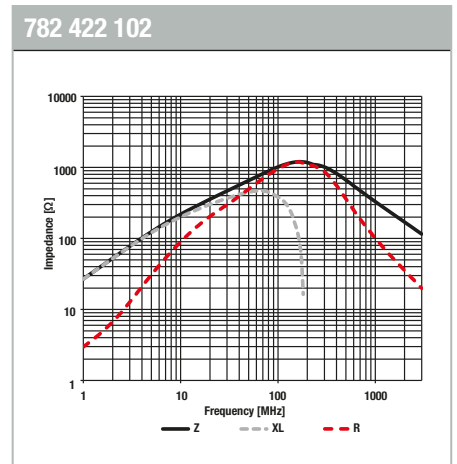
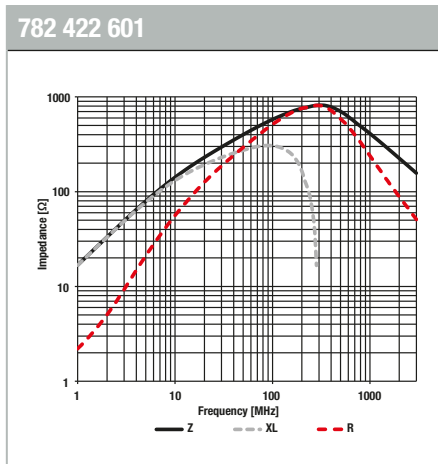
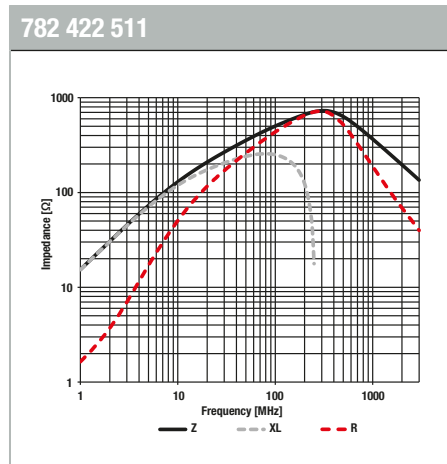
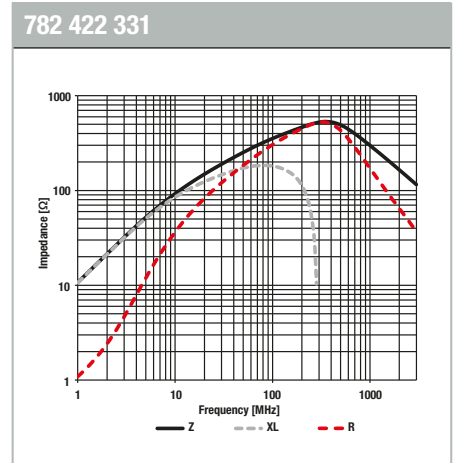
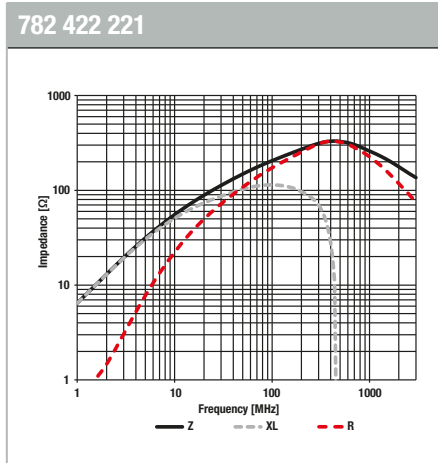
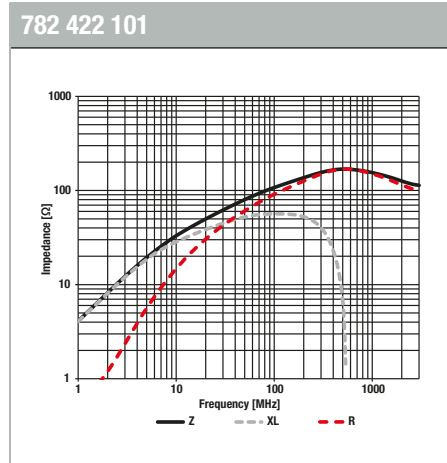

High Current

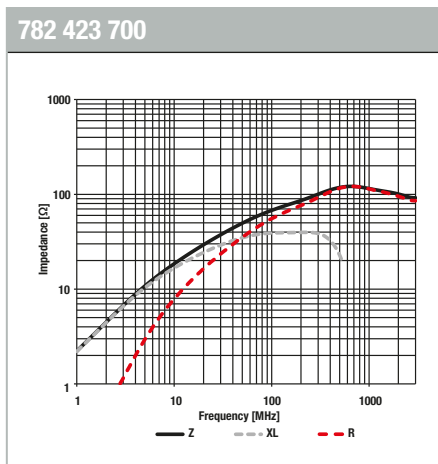
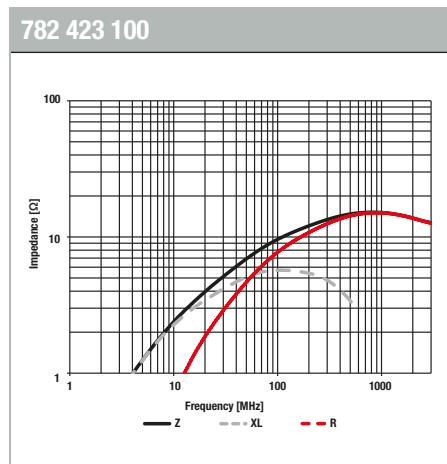

WE-CBA

SMD EMI Suppression Ferrite Bead

Size 0603

Electrical properties

Order Code	Z @ 100 MHz (Ω)	Z _{max} (Ω)	Testcondition Z _{max} (MHz)	I _R (mA)	R _{DC} (Ω)	Type of Application
782 631 101	100	610	400	500	0.20	High Speed
782 631 331	330	690	280	400	0.25	High Speed
782 631 182	1800	2300	130	100	0.75	High Speed
782 632 620	62	95	500	500	0.15	Wide Band
782 632 121	120	190	450	500	0.20	Wide Band
782 632 181	180	280	380	500	0.20	Wide Band
782 632 511	510	610	200	300	0.35	Wide Band
782 632 102	1000	1100	150	200	0.50	Wide Band
782 633 620	62	98	600	2500	0.04	High Current
782 633 601	600	660	190	1000	0.20	High Current

Dimensions (in mm)



Land pattern (in mm)



WIDE BAND / HIGH SPEED: W = 2,2
HIGH CURRENT: W = 2,6

Typical impedance characteristics High Speed

782 631 101



782 631 331



782 631 182



WE-CBA

SMD EMI Suppression Ferrite Bead

Size 0603



Typical impedance characteristics Wide Band

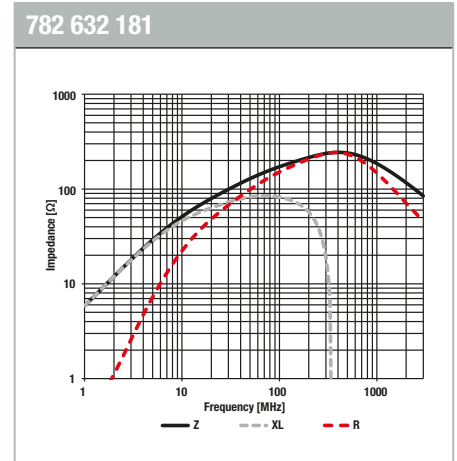

High Current

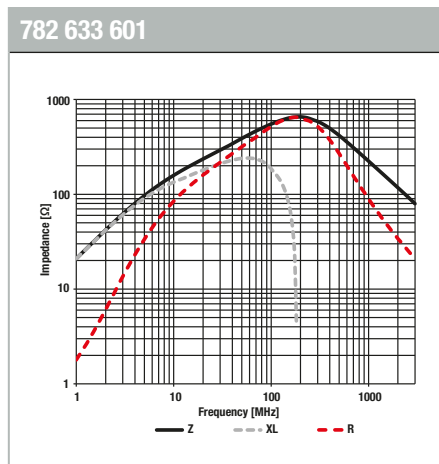
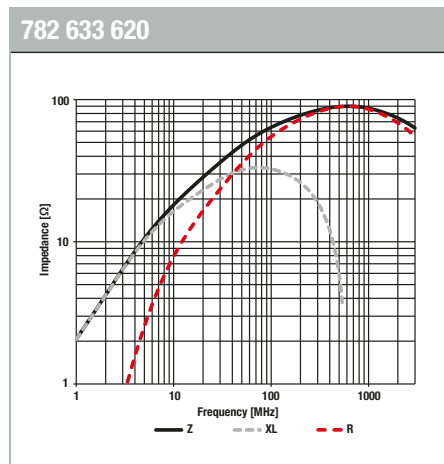

WE-CBA

SMD EMI Suppression Ferrite Bead

Size 0805

Electrical properties

Order Code	Z @ 100 MHz (Ω)	Z _{max} (Ω)	Testcondition Z _{max} (MHz)	I _R (mA)	R _{DC} (Ω)	Type of Application
782 851 102	1000	1100	150	300	0.350	High Speed
782 851 202	2200	2200	100	200	0.450	High Speed
782 853 200	20	35	700	5000	0.008	High Current
782 853 270	27	45	700	4000	0.015	High Current
782 853 680	68	110	500	3000	0.025	High Current
782 853 910	91	105	400	2000	0.060	High Current
782 853 121	120	180	300	2500	0.035	High Current
782 853 221	220	290	200	2000	0.050	High Current
782 853 561	560	600	160	1500	0.100	High Current
782 853 112	1100	1400	70	800	0.300	High Current
782 853 152	1500	1800	70	700	0.350	High Current

Dimensions (in mm)



Land pattern (in mm)



HIGH SPEED: W = 3,0
HIGH CURRENT: W = 4,0

Typical impedance characteristics High Speed

782 851 102



782 851 202



WE-CBA

SMD EMI Suppression Ferrite Bead

Size 0805



Typical impedance characteristics High Current



WE-CBA

SMD EMI Suppression Ferrite Bead

Size 1206

Electrical properties

Order Code	Z @ 100 MHz (Ω)	Z _{max} (Ω)	Testcondition Z _{max} (MHz)	I _R (mA)	R _{DC} (Ω)	Type of Application
782 762 301	300	360	160	500	0.100	Wide Band
782 763 820	82	130	500	3000	0.025	High Current
782 763 621	620	620	100	1500	0.100	High Current
782 763 102	1000	1200	80	1000	0.300	High Current

Land pattern (in mm)



WIDE BAND: W = 4,2
HIGH CURRENT: W = 5,2

Dimensions (in mm)



Typical impedance characteristics

Wide Band

782 762 301



High Current

782 763 820



782 763 621



782 763 102



WE-CBA

SMD EMI Suppression Ferrite Bead

Size 1806



Electrical properties						
Order Code	Z @ 100 MHz (Ω)	Z _{max} (Ω)	Testcondition Z _{max} (MHz)	I _R (mA)	R _{DC} (Ω)	Type of Application
782 963 560	56	90	1000	5000	0.008	High Current
782 963 820	82	110	1000	3500	0.020	High Current



Typical impedance characteristics High Current



WE-AEFA

Axial EMI Suppression Ferrite



Temperature range
up to +150 °C



Characteristics

- Ferrite core made of NiZn, a material which works in a wide frequency range
- Many different types for the best possible interference suppression
- Operating temperature: -55 °C up to +150 °C

Applications

- In general for: wires, coaxial cables, wire-wrapping cables, multiconductor wires
- Data and signal lines
- On board power supply line
- Multimedia cable interfaces
- Various, other cable interfaces

Electrical properties

Order Code	OD (mm)	ID (mm)	H (mm)	Cable Diameter (mm)	Z @ 25 MHz 1 turn (Ω)	Z @ 100 MHz 1 turn (Ω)
782 013 033 150	12.0	3.55	15.0	≤ 3.3	150	205
782 013 044 095	9.5	4.75	9.5	≤ 4.4	60	84
782 013 046 185	11.5	5.0	18.5	≤ 4.6	135	186
782 013 046 250	11.5	5.0	25.0	≤ 4.6	185	255
782 013 057 450	12.0	6.1	45.0	≤ 5.7	255	370
782 013 059 285	14.0	6.3	28.5	≤ 5.9	195	270
782 013 068 250	14.0	7.2	25.0	≤ 6.8	150	210
782 013 069 155	12.0	7.3	15.5	≤ 6.9	70	100
782 013 069 285	15.5	7.3	28.5	≤ 6.9	190	270
782 013 076 285	16.0	8.0	28.5	≤ 7.6	170	240
782 013 076 508	16.0	8.0	50.8	≤ 7.6	325	460
782 013 079 285	14.0	8.2	28.5	≤ 7.9	140	200
782 013 086 280	16.0	9.0	28.0	≤ 8.6	140	205
782 013 091 285	17.5	9.5	28.5	≤ 9.1	150	220
782 013 100 280	15.5	10.5	28.0	≤ 10.0	100	150
782 013 110 508	19.0	11.5	50.8	≤ 11.0	235	345
782 013 125 280	19.0	13.0	28.0	≤ 12.5	95	150
782 013 125 285	26.0	13.0	28.5	≤ 12.5	170	240
782 013 150 285	26.0	15.5	28.5	≤ 15.0	130	190

Dimensions (in mm)



WE-AEFA

Axial EMI Suppression Ferrite



Typical impedance characteristics



Typical impedance characteristics



WE-PDA SMD Shielded Power Inductor

Size 7332



Characteristics

- Wire connection: welding technology
- Operating Temperature -40°C up to +125 °C
- Highest possible current loading for SMD Inductors
- Magnetically shielded version which results in a low leakage field
- High storage capacity
- Low self-losses
- Core Material: NiZn

Applications

- Multimedia applications
- Switching regulators with low operating voltages (Computer, Notebook, smart phones)
- Integrated DC/DC-converter
- Perfect suitable for switching regulators with extremely high efficiency (> 86 %)

Electrical properties

Order Code	L (µH)	Tolerance (%)	R _{DC} (mΩ) max.	I _R (A)	I _{Sat} (A)
784 778 010	1.0	20%	36	5.37	6.40
784 778 022	2.2	20%	50	4.00	4.80
784 778 033	3.3	20%	65	3.42	4.20
784 778 047	4.7	20%	79	2.90	3.90
784 778 068	6.8	20%	95	2.50	2.75
784 778 082	8.2	20%	103	2.2	2.4
784 778 100	10	20%	126	1.83	2.20
784 778 220	22	20%	190	1.40	1.40
784 778 470	47	20%	350	1.10	1.00
784 778 101	100	20%	720	0.75	0.67
784 778 221	220	20%	1620	0.54	0.42
784 778 471	470	20%	3300	0.32	0.31
784 778 102	1000	20%	7200	0.20	0.18

Dimensions (in mm)



Land pattern (in mm)



Inductance vs. Current

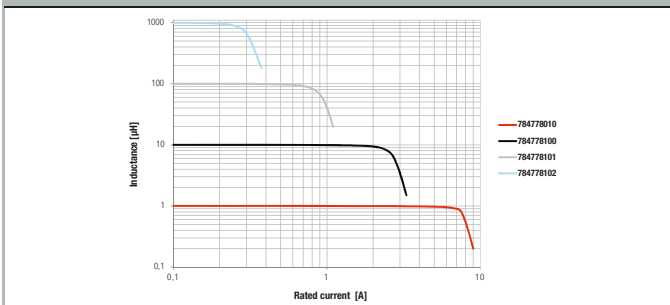

WE-PDA

SMD Shielded Power Inductor

Size 7345

Electrical properties

Order Code	L (µH)	Tolerance (%)	R _{DC} (mΩ) max.	I _R (A)	I _{Sat} (A)
784 777 010	1.0	20%	38	3.7	8
784 777 022	2.2	20%	60	2.7	5.25
784 777 033	3.3	20%	69	2.5	4.7
784 777 047	4.7	20%	84	2.35	3.7
784 777 068	6.8	20%	99	2.2	3.2
784 777 082	8.2	20%	115	2	2.8
784 777 100	10	20%	126	1.9	2.6
784 777 220	22	20%	215	1.4	1.8
784 777 470	47	20%	300	1.15	1.25
784 777 101	100	20%	470	0.72	0.80
784 777 221	220	20%	1135	0.56	0.53
784 777 471	470	20%	2720	0.35	0.38
784 777 102	1000	20%	5760	0.25	0.28

Dimensions (in mm)

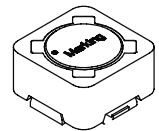
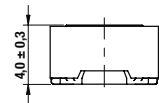

Land pattern (in mm)



Inductance vs. Current

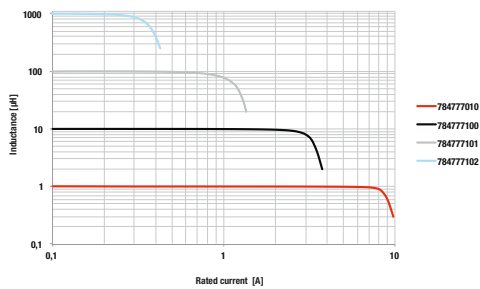

WE-PDA SMD Shielded Power Inductor

Size 1260



Electrical properties					
Order Code	L (µH)	Tolerance (%)	R _{DC} (mΩ) max.	I _R (A)	I _{Sat} (A)
784 771 010	1.0	20%	8.50	9.00	16.50
784 771 022	2.2	20%	12.50	7.20	10.50
784 771 033	3.3	20%	14.70	6.50	9.00
784 771 047	4.7	20%	17.50	6.20	8.00
784 771 068	6.8	20%	21.50	5.50	6.00
784 771 082	8.2	20%	24.00	5.05	5.50
784 771 100	10	20%	26.50	5.00	5.25
784 771 220	22	20%	41.00	3.20	3.50
784 771 470	47	20%	77.00	2.30	2.50
784 771 101	100	20%	174	1.50	1.70
784 771 221	220	20%	348	0.99	1.10
784 771 471	470	20%	706	0.65	0.75
784 771 102	1000	20%	1704	0.48	0.53

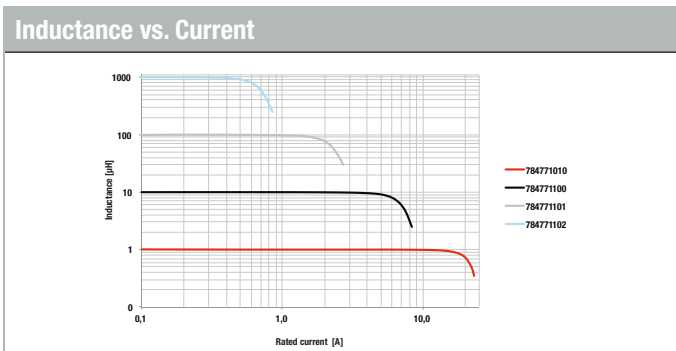
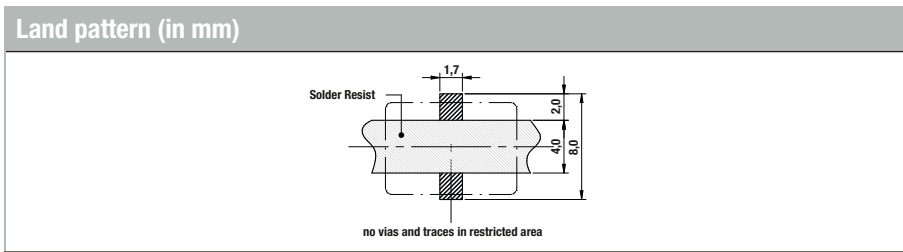
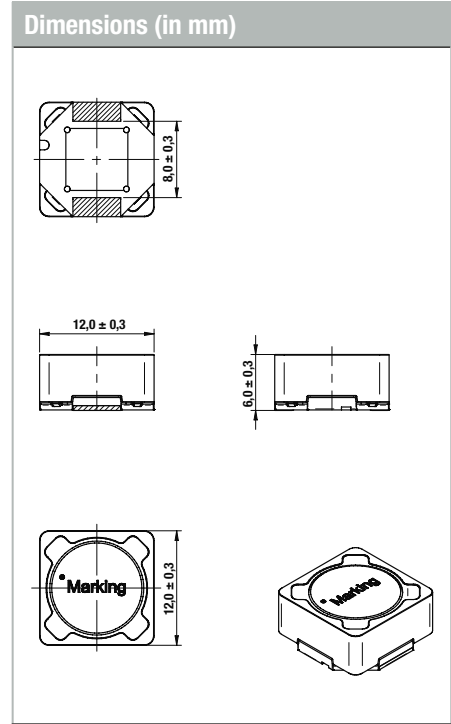

WE-PDA

SMD Shielded Power Inductor

Size 1280

Electrical properties

Order Code	L (µH)	Tolerance (%)	R _{DC} (mΩ) max.	I _R (A)	I _{Sat} (A)
784 770 10	1.0	20%	9.8	8.3	22.0
784 770 22	2.2	20%	14.5	7.0	15.0
784 770 33	3.3	20%	21.4	6.6	12.0
784 770 47	4.7	20%	19.8	6.0	11.0
784 770 68	6.8	20%	25	5.2	8.5
784 770 100	10	20%	31	5.0	6.8
784 770 220	22	20%	45	4.0	4.7
784 770 470	47	20%	70	3.1	3.4
784 770 101	100	20%	145	2.1	2.3
784 770 221	220	20%	300	1.2	1.4
784 770 471	470	20%	570	0.8	1.0
784 770 102	1000	20%	1199	0.72	0.8

Dimensions (in mm)



Land pattern (in mm)



Inductance vs. Current

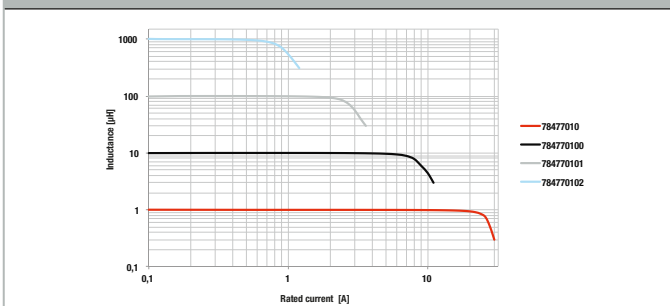

WE-PDA SMD Shielded Power Inductor

Size 1210



Electrical properties					
Order Code	L (µH)	Tolerance (%)	R _{DC} (mΩ) max.	I _R (A)	I _{Sat} (A)
784 770 9010	1.0	20%	9.60	9.2	23
784 770 9022	2.2	20%	14.5	7.5	16
784 770 9033	3.3	20%	17.00	7.0	13.5
784 770 9047	4.7	20%	19.50	6.0	11.0
784 770 9068	6.8	20%	24.50	5.5	9.0
784 770 9100	10	20%	29.50	5.0	7.5
784 770 9220	22	20%	45.00	4.3	5.0
784 770 9470	47	20%	67.00	3.2	3.5
784 770 9101	100	20%	123.00	2.2	2.4
784 770 9221	220	20%	247.00	1.45	1.6
784 770 9471	470	20%	495.00	0.9	1.1
784 770 9102	1000	20%	1060.00	0.63	0.7

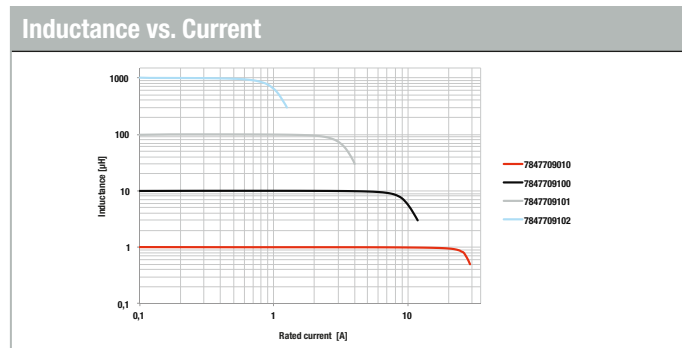
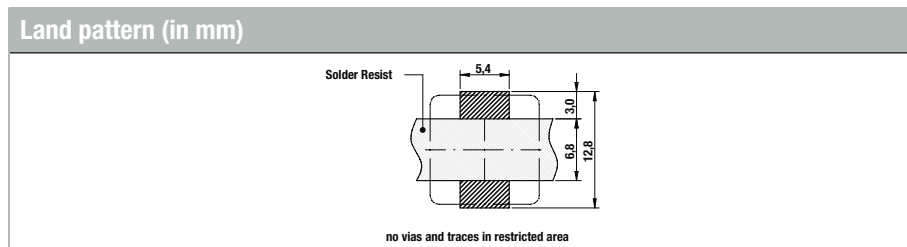
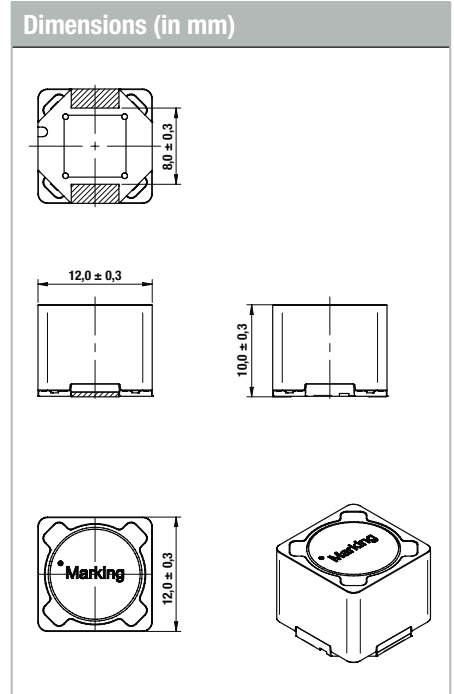

WE-PD2A

SMD Power Inductor

Size 4532



Characteristics

- Open size
- Current capability up to 14 A
- Operating temperature: -40 °C to +125 °C
- Recommended solder profile: Reflow

Applications

- Switching regulators with low operating voltage (navigation system, air conditioning, entertainment, park assistance control)
- Integrated DC/DC-converter
- Perfectly suitable for switching regulators with extremely high efficiency

Note

The ambient temperature when operating the WE-PD series of storage chokes at full current rating load should generally range from -40 °C to +85 °C. The self-heating of the component must be taken into account at higher ambient temperatures in order that the permissible solder joint temperature is not exceeded or the wire insulation damaged. The wire used can withstand a temperature of up to +150 °C. The ferrite core itself may be used over a far greater temperature range (approx. -50 °C to +250 °C [Curie temperature]). However, in this case, the tolerance limits of the inductor may be exceeded due to the temperature dependence of permeability.

Current derating at ambient temperature of > 85 °C



Inductance vs. DC bias current



Electrical properties: Size 4532

Order Code	L (µH)	Tolerance (%)	R _{DC} typ. (Ω)	R _{DC} max. (Ω)	I _R (A)	I _{sat} (A)
784 773 0	1.0	±20	0.014	0.049	4.00	5.72
784 773 018	1.8		0.028	0.064	2.70	3.60
784 773 022	2.2		0.034	0.071	2.50	3.38
784 773 033	3.3		0.041	0.086	2.00	2.88
784 773 039	3.9		0.054	0.094	1.88	2.57
784 773 047	4.7		0.059	0.110	1.82	2.46
784 773 056	5.6		0.069	0.126	1.58	2.43
784 773 068	6.8		0.076	0.131	1.54	2.10
784 773 082	8.2		0.116	0.146	1.50	1.80
784 773 10	10		0.118	0.182	1.45	1.74
784 773 112	12		0.156	0.210	1.28	1.62
784 773 115	15		0.204	0.235	1.20	1.46
784 773 118	18	0.225	0.338	1.10	1.29	
784 773 122	22	0.261	0.370	1.00	1.22	
784 773 127	27	±10	0.328	0.522	0.94	1.00
784 773 133	33		0.370	0.540	0.86	0.90
784 773 139	39		0.418	0.587	0.77	0.87
784 773 147	47		0.523	0.844	0.68	0.77
784 773 156	56		0.714	0.937	0.64	0.75
784 773 168	68		0.754	1.117	0.56	0.68

Dimensions (in mm): Size 4532



WE-PD2A SMD Power Inductor

Size 4532 / Size 5848



Inductance vs. rated current: Size 4532



Land pattern (in mm): Size 4532



Electrical properties: Size 5848

Order Code	L (µH)	Tolerance (%)	R _{DC} typ. (Ω)	R _{DC} max. (Ω)	I _R (A)	I _{sat} (A)
784 774 003	0.33	±20	0.006	0.008	10.8	15.30
784 774 006	0.6	-40/+20	0.009	0.018	8.20	13.50
784 774 022	2.2	±20	0.026	0.041	4.60	8.20
784 774 027	2.7		0.032	0.045	4.00	8.00
784 774 033	3.3		0.042	0.060	3.70	7.50
784 774 047	4.7		0.056	0.071	3.00	5.50
784 774 068	6.8		0.071	0.082	2.40	4.50
784 774 10	10		0.078	0.100	2.20	2.50
784 774 112	12		0.082	0.110	2.00	1.94
784 774 115	15		0.089	0.140	1.53	1.90
784 774 118	18		0.104	0.150	1.45	1.69
784 774 122	22		0.109	0.180	1.28	1.53
784 774 127	27	0.133	0.200	1.19	1.40	
784 774 133	33	±15	0.150	0.230	1.09	1.17
784 774 139	39		0.215	0.320	0.94	1.10
784 774 147	47		0.260	0.370	0.86	1.00
784 774 156	56	±10	0.298	0.420	0.77	0.90
784 774 168	68		0.313	0.460	0.64	0.86
784 774 182	82		0.475	0.600	0.60	0.72
784 774 20	100		0.510	0.650	0.57	0.68
784 774 212	120		0.660	0.930	0.49	0.63
784 774 215	150		0.720	1.100	0.46	0.54
784 774 218	180		0.850	1.380	0.42	0.50
784 774 222	220		0.945	1.570	0.41	0.47

Dimensions (in mm): Size 5848



Inductance vs. rated current: Size 5848



Land pattern (in mm): Size 5848



WE-PD2A

SMD Power Inductor

Size 7850

Electrical properties

Order Code	L (µH)	Tolerance (%)	R _{DC} typ. (Ω)	R _{DC} max. (Ω)	I _R (A)	I _{sat} (A)	
784 775 012	1.2	±20	0.005	0.006	6.18	8.00	
784 775 022	2.2		0.008	0.010	6.00	6.00	
784 775 033	3.3		0.012	0.014	4.90	4.90	
784 775 047	4.7		0.016	0.019	4.50	4.50	
784 775 056	5.6		0.018	0.022	4.00	4.00	
784 775 068	6.8		0.022	0.026	3.70	3.80	
784 775 082	8.2		0.024	0.029	3.20	3.20	
784 775 110	10		±10	0.040	0.070	2.30	2.95
784 775 112	12			0.042	0.080	2.18	2.23
784 775 115	15			0.044	0.090	1.93	2.20
784 775 118	18	0.053		0.100	1.89	2.14	
784 775 122	22	0.065		0.110	1.76	1.81	
784 775 127	27	0.074		0.120	1.48	1.62	
784 775 133	33	0.089		0.130	1.35	1.47	
784 775 139	39	0.116		0.160	1.25	1.33	
784 775 147	47	0.134		0.180	1.17	1.24	
784 775 168	68	0.218		0.280	0.99	1.05	
784 775 182	82	0.248	0.370	0.90	0.95		
784 775 20	100	0.281	0.430	0.77	0.86		
784 775 212	120	0.340	0.470	0.67	0.81		
784 775 215	150	0.467	0.640	0.60	0.71		
784 775 218	180	0.574	0.710	0.55	0.57		
784 775 222	220	0.614	0.960	0.51	0.56		
784 775 227	270	0.699	1.110	0.47	0.51		
784 775 233	330	0.980	1.260	0.43	0.48		
784 775 239	390	1.151	1.770	0.38	0.43		
784 775 247	470	1.370	1.960	0.360	0.38		

Dimensions (in mm)



Inductance vs. rated current

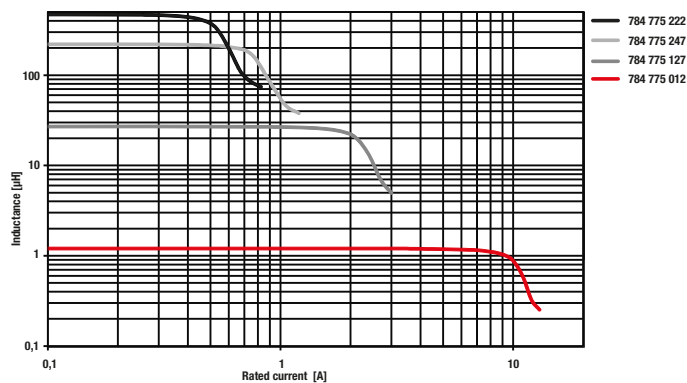

Land pattern (in mm)



WE-PD2A SMD Power Inductor

Size 1054



Electrical properties						
Order Code	L (µH)	Tolerance (%)	R _{DC} typ. (Ω)	R _{DC} max. (Ω)	I _R (A)	I _{sat} (A)
784 776 012	1.2	±20	0.004	0.0048	7.40	11.00
784 776 022	2.2		0.007	0.0078	7.00	8.00
784 776 033	3.3		0.009	0.0102	6.00	7.00
784 776 047	4.7		0.012	0.014	5.00	6.00
784 776 056	5.6		0.015	0.018	4.80	5.50
784 776 068	6.8		0.016	0.019	4.40	5.00
784 776 082	8.2		0.020	0.024	4.20	4.25
784 776 10	10		0.028	0.060	2.98	3.24
784 776 112	12		0.033	0.070	2.72	3.15
784 776 115	15		0.034	0.080	2.47	2.88
784 776 118	18		0.043	0.090	2.36	2.43
784 776 122	22		0.051	0.100	2.04	2.07
784 776 127	27		0.063	0.110	1.95	1.98
784 776 133	33		0.083	0.120	1.78	1.89
784 776 139	39		0.088	0.140	1.62	1.80
784 776 147	47		0.095	0.170	1.45	1.62
784 776 156	56		0.112	0.190	1.36	1.53
784 776 168	68	0.138	0.220	1.19	1.49	
784 776 182	82	0.150	0.250	1.11	1.17	
784 776 20	100	±10	0.200	0.350	1.02	1.10
784 776 212	120		0.243	0.400	0.94	0.99
784 776 215	150		0.300	0.470	0.81	0.90
784 776 218	180		0.320	0.630	0.76	0.78
784 776 222	220		0.451	0.730	0.67	0.77
784 776 227	270		0.500	0.970	0.62	0.68
784 776 233	330		0.750	1.150	0.52	0.59
784 776 239	390		0.794	1.300	0.49	0.54
784 776 247	470		0.969	1.480	0.44	0.50

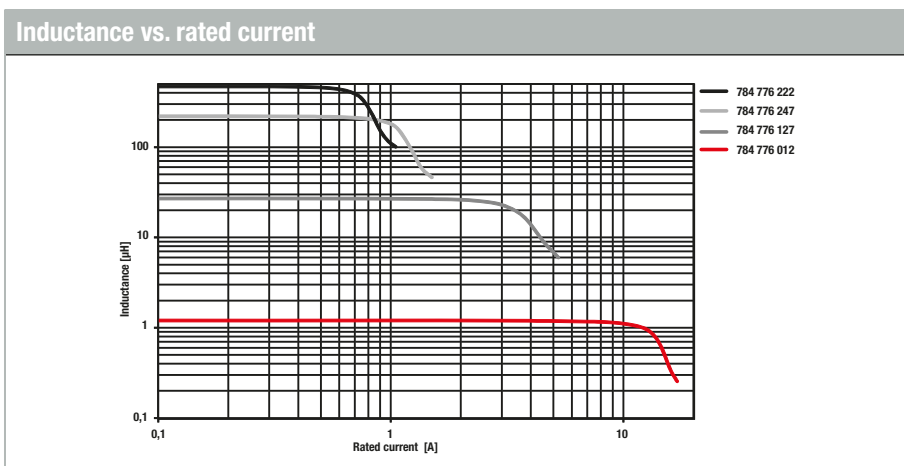
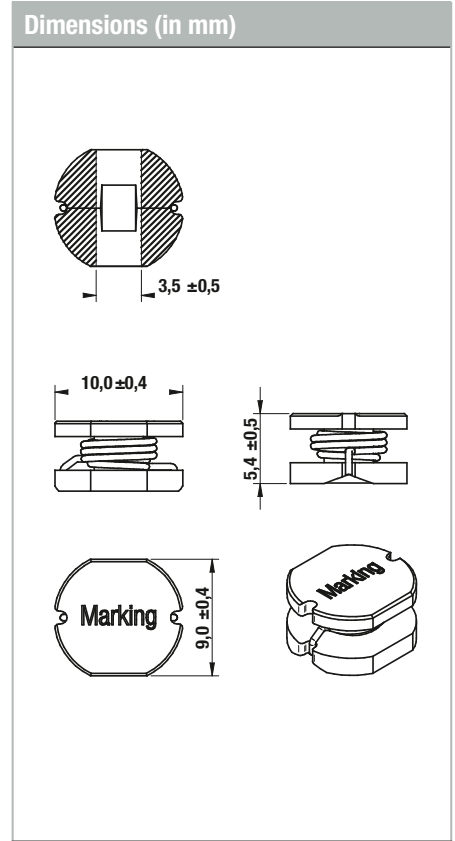

WE-MAIA

SMD Metal Alloy Power Inductor

Size 2506 / Size 2508



Characteristics

- Magnetic iron alloy allows high rated currents
- Compact design
- Magnetically shielded
- High current capability and handles high transient current spikes
- Low acoustic noise and low leakage flux noise
- Operating temperature: $-40\text{ }^{\circ}\text{C}$ to $125\text{ }^{\circ}\text{C}$

NEW!

**4-times higher saturation current
Best efficiency Minimized package**

Applications

- DC/DC-converter for high current power supplies
- DC/DC-converter for Field Programmable Gate Array (FPGA)
- POL-converters
- Portable power like PDA, digital camera
- Mainboards/graphic cards
- Battery powered devices
- Wireless communication devices
- Power supplies for smartphones, tablet PCs and other mobile devices

Electrical properties: Size 2506

Order Code	L (μH)	Tolerance (%)	I_R (A)	I_{sat} (A)	$R_{\text{DC typ.}}$ (m Ω)	$R_{\text{DC max.}}$ (m Ω)
784 383 210 047	0.47	± 30	2.2	3.7	76.0	95.0
784 383 210 10	1.0		1.25	2.5	163.0	196.0

I_R referring to 40 K heating above ambient temperature
 I_{sat} referring to inductance loss of 20% typical

Dimensions (in mm)

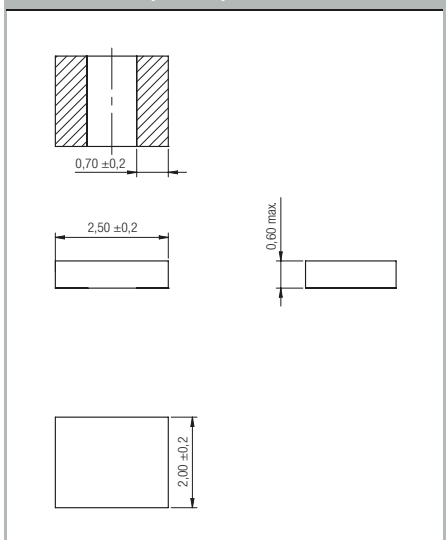

Soldering Pad (in mm)

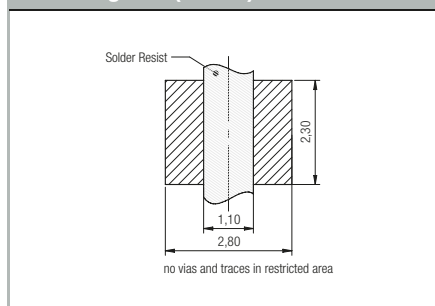

Electrical properties: Size 2508

Order Code	L (μH)	Tolerance (%)	I_R (A)	I_{sat} (A)	$R_{\text{DC typ.}}$ (m Ω)	$R_{\text{DC max.}}$ (m Ω)
784 383 220 047	0.47	± 30	2.25	4.4	70.0	87.0
784 383 220 10	1.0		1.75	3.35	107.0	133.0
784 383 220 22	2.2		1.34	2.2	252.0	302.0

I_R referring to 40 K heating above ambient temperature
 I_{sat} referring to inductance loss of 20% typical

Dimensions (in mm)

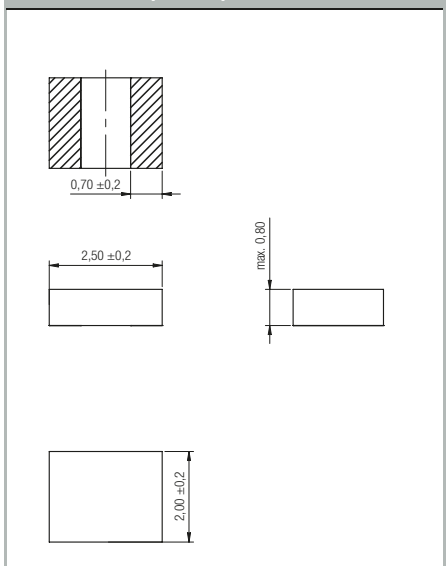

Soldering Pad (in mm)

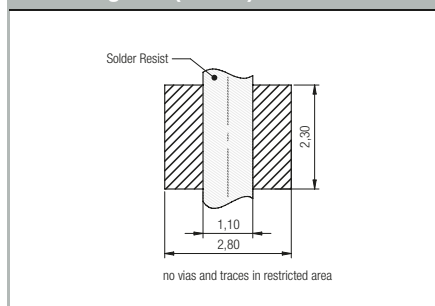

WE-MAIA

SMD Metal Alloy Power Inductor

Size 2510 / Size 3010



Electrical properties: Size 2510						
Order Code	L (μH)	Tolerance (%)	I _R (A)	I _{sat} (A)	R _{DC typ.} (mΩ)	R _{DC max.} (mΩ)
784 383 230 033	0.33	±30	3.4	6.2	29.0	38.0
784 383 230 047	0.47	±30	3.2	5.5	37.0	48.0
784 383 230 068	0.68	±30	3.1	4.7	46.0	60.0
784 383 230 082	0.82	±30	2.6	4.25	53.0	69.0
784 383 230 10	1.0	±20	2.5	4.0	63.0	75.0
784 383 230 12	1.2	±20	1.9	3.8	82.0	106
784 383 230 15	1.5	±20	1.8	3.5	92.0	110
784 383 230 22	2.2	±20	1.3	2.5	147	176
784 383 230 33	3.3	±20	1.25	2.1	220	264
784 383 230 47	4.7	±20	0.94	1.75	338	388
784 383 230 68	6.8	±20	0.85	1.55	563	648
784 383 230 82	8.2	±20	0.7	1.45	646	743
784 383 231 00	10.0	±20	0.6	1.35	733	843

I_R referring to 40 K heating above ambient temperature
I_{sat} referring to inductance loss of 20% typical



Electrical properties: Size 3010						
Order Code	L (μH)	Tolerance (%)	I _R (A)	I _{sat} (A)	R _{DC typ.} (mΩ)	R _{DC max.} (mΩ)
784 383 330 22	2.2	±20	1.4	3.9	150	172
784 383 330 33	3.3		1.1	2.95	232	266
784 383 330 47	4.7		0.9	2.4	305	350

I_R referring to 40 K heating above ambient temperature
I_{sat} referring to inductance loss of 20% typical



WE-MAIA

SMD Metal Alloy Power Inductor

Size 3012

Electrical properties: Size 3012

Order Code	L (μH)	Tolerance (%)	I_R (A)	I_{sat} (A)	$R_{\text{DC typ.}}$ ($\text{m}\Omega$)	$R_{\text{DC max.}}$ ($\text{m}\Omega$)
784 383 340 033	0.33	± 30	4.8	11.1	13.2	15.8
784 383 340 047	0.47	± 30	4.0	9.4	16.6	19.9
784 383 340 056	0.56	± 30	3.6	8.5	27.0	32.4
784 383 340 068	0.68	± 20	3.5	7.7	28.7	34.4
784 383 340 10	1.0	± 20	2.75	6.6	41.2	50.5
784 383 340 12	1.2	± 20	2.65	6.0	46.8	56.1
784 383 340 15	1.5	± 20	2.0	5.7	75.3	90.3
784 383 340 22	2.2	± 20	1.80	5.0	100	115.0
784 383 340 33	3.3	± 20	1.4	4.0	136.8	164.2
784 383 340 47	4.7	± 20	1.1	3.8	222.6	256
784 383 340 56	5.6	± 20	1.0	3.0	338.3	389
784 383 340 68	6.8	± 20	0.88	2.7	368.2	423.4

I_R referring to 40 K heating above ambient temperature
 I_{sat} referring to inductance loss of 20% typical

Dimensions (in mm)

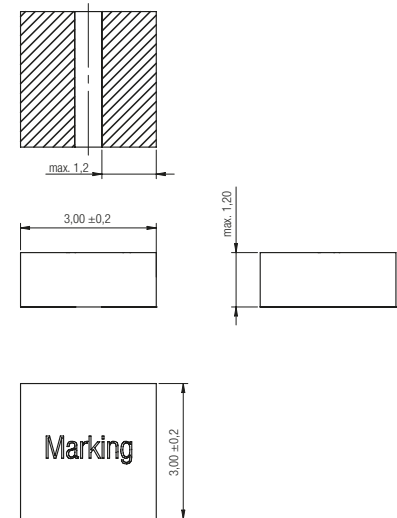

Soldering Pad (in mm)

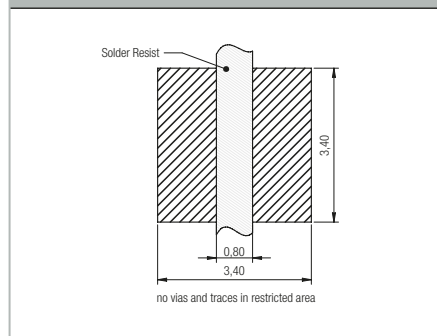

WE-MAIA

SMD Metal Alloy Power Inductor

Size 3015



Electrical properties: Size 3015						
Order Code	L (μ H)	Tolerance (%)	I_R (A)	I_{sat} (A)	$R_{DC\ typ.}$ (m Ω)	$R_{DC\ max.}$ (m Ω)
784 383 350 047	0.47	$\pm 30\%$	4.6	5.8	20.0	23.0
784 383 350 068	0.68	$\pm 30\%$	4.1	8.1	25.0	30.0
784 383 350 082	0.82	$\pm 30\%$	3.5	7.0	30	35.0
784 383 350 10	1.0	$\pm 20\%$	2.7	4.5	39.0	47.0
784 383 350 22	2.2	$\pm 20\%$	1.8	3.5	94.0	108
784 383 350 33	3.3	$\pm 20\%$	1.7	3.2	114	131
784 383 350 47	4.7	$\pm 20\%$	1.5	2.8	141	162
784 383 350 68	6.8	$\pm 20\%$	1.1	2.4	250	287
784 383 351 00	10.0	$\pm 20\%$	0.85	2.0	446	513
784 383 351 50	15.0	$\pm 20\%$	0.65	1.71	720	830
784 383 352 20	22.0	$\pm 20\%$	0.60	1.60	940	1040
784 383 353 30	33.0	$\pm 20\%$	0.50	1.30	1210	1330
784 383 354 70	47.0	$\pm 20\%$	0.39	1.18	2090	2300

I_R referring to 40 K heating above ambient temperature
 I_{sat} referring to inductance loss of 20% typical



Design Kit WE-CBA

SMD EMI Suppression Ferrite Bead

Order Code 782 792, Version 1.1



Characteristics

- Reliable Ni-Sn electrodes
- High rated current up to 5 A
- Recommended soldering: Reflow
- Operating temperature: -55 °C to +125 °C

Applications

- Perfect as data lined filter and for uncoupling of distribution voltage

Electrical properties

Order Code	Size	Z @ 100 MHz (Ω)	I _R (mA)	R _{DC} (Ω)	Type of Application
782 422 101	0402	100	500	0.300	Wide Band
782 422 221		220	400	0.300	Wide Band
782 422 331		330	300	0.500	Wide Band
782 422 511		510	200	0.800	Wide Band
782 422 601		600	200	0.800	Wide Band
782 422 102		1000	200	1.000	Wide Band
782 423 100		10	1500	0.030	High Current
782 423 700	70	1000	0.090	High Current	
782 631 101	0603	100	500	0.200	High Speed
782 631 331		330	400	0.250	High Speed
782 631 182		1800	100	0.750	High Speed
782 632 620		62	500	0.150	Wide Band
782 632 121		120	500	0.200	Wide Band
782 632 181		180	500	0.200	Wide Band
782 632 511		510	300	0.350	Wide Band
782 632 102		1000	200	0.500	Wide Band
782 633 620		62	2500	0.040	High Current
782 633 601		600	1000	0.200	High Current
782 851 102	0805	1000	300	0.350	High Speed
782 851 202		2200	200	0.450	High Speed
782 853 200		20	5000	0.008	High Current
782 853 270		27	4000	0.015	High Current
782 853 680		68	3000	0.025	High Current
782 853 910		91	2000	0.060	High Current
782 853 121		120	2500	0.035	High Current
782 583 221		220	2000	0.050	High Current
782 853 561		560	1500	0.100	High Current
782 853 112		1100	800	0.300	High Current
752 853 152	1500	700	0.350	High Current	
782 762 301	1206	300	500	0.100	Wide Band
782 763 820		82	3000	0.025	High Current
782 763 621		620	1500	0.100	High Current
782 763 102		1000	1000	0.300	High Current
782 963 560	1806	56	5000	0.008	High Current
782 963 820		82	3500	0.020	High Current



Design Kit WE-AEFA

Axial EMI Suppression Ferrite

Order Code 782 013, Version 1.1



Characteristics

- Ferrite core made of NiZn, a material which works in a wide frequency range
- Many different types for the best possible interference suppression
- Operating temperature: -55 °C up to +150 °C

Applications

- In general for: wires, coaxial cables, wire-wrapping cables, multiconductor wires
- Data and signal lines
- On board power supply line
- Multimedia cable interfaces
- Various, other cable interfaces

Electrical properties

Order Code	OD (mm)	ID (mm)	H (mm)	Cable Diameter (mm)	Z @ 25 MHz 1 turn (Ω)	Z @ 100 MHz 1 turn (Ω)
782 013 033 150	12.0	3.55	15.0	≤ 3.3	150	205
782 013 044 095	9.5	4.75	9.5	≤ 4.4	60	84
782 013 046 185	11.5	5.0	18.5	≤ 4.6	135	186
782 013 046 250	11.5	5.0	25.0	≤ 4.6	185	255
782 013 057 450	12.0	6.1	45.0	≤ 5.7	255	370
782 013 059 285	14.0	6.3	28.5	≤ 5.9	195	270
782 013 068 250	14.0	7.2	25.0	≤ 6.8	150	210
782 013 069 155	12.0	7.3	15.5	≤ 6.9	70	100
782 013 069 285	15.5	7.3	28.5	≤ 6.9	190	270
782 013 076 285	16.0	8.0	28.5	≤ 7.6	170	240
782 013 076 508	16.0	8.0	50.8	≤ 7.6	325	460
782 013 079 285	14.0	8.2	28.5	≤ 7.9	140	200
782 013 086 280	16.0	9.0	28.0	≤ 8.6	140	205
782 013 091 285	17.5	9.5	28.5	≤ 9.1	150	220
782 013 100 280	15.5	10.5	28.0	≤ 10.0	100	150
782 013 110 508	19.0	11.5	50.8	≤ 11.0	235	345
782 013 125 280	19.0	13.0	28.0	≤ 12.5	95	150
782 013 125 285	26.0	13.0	28.5	≤ 12.5	170	240
782 013 150 285	26.0	15.5	28.5	≤ 15.0	130	190

Design Kit WE-PDA

SMD Power Inductor

Order Code 784 770 & 784 778, Version 1.1



Characteristics

- Wire connection: welding technology
- Operating Temperature -40 °C up to +125 °C
- Highest possible current loading for SMD Inductors
- Magnetically shielded version which results in a low leakage field
- High storage capacity
- Low self-losses
- Core Material: NiZn

Applications

- Multimedia applications
- Switching regulators with low operating voltages (Computer, Notebook, smart phones)
- Integrated DC/DC-converter
- Perfect suitable for switching regulators with extremely high efficiency (> 86%)

Electrical properties: Order Code 784 770

Order Code	Size	L (µH)	R _{DC} (Ω)	I _R (A)	I _{sat} (A)
784 771 010	1260	1	8.50	9.00	16.50
784 771 022		2.2	12.50	7.20	10.50
784 771 033		3.3	14.50	6.50	9.00
784 771 047		4.7	17.50	6.20	8.00
784 771 068		6.8	21.50	5.50	6.00
784 771 082		8.2	24.00	5.05	5.50
784 771 100		10	26.50	5.00	5.25
784 771 220		22	40.00	3.20	3.50
784 771 470		47	77.00	2.30	2.50
784 771 101		100	174	1.50	1.70
784 771 221		220	348	0.99	1.10
784 771 102		1000	1705	0.48	0.53
784 770 10	1280	1	9.00	8.30	22.00
784 770 22		2.2	14.50	7.00	15.00
784 770 33		3.3	17.00	6.60	12.00
784 770 47		4.7	20.00	6.00	11.00
784 770 68		6.8	25.00	5.20	8.50
784 770 100		10	31.00	5.00	6.80
784 770 220		22	44.50	4.00	4.70
784 770 470		47	71.00	3.10	3.40
784 770 101		100	144.00	2.10	2.30
784 770 471		470	570.00	0.80	1.00
784 770 102		1000	1200.00	0.72	0.80
784 770 901 0		1210	1	8.50	9.20
784 770 902 2	2.2		14.50	7.50	16.00
784 770 903 3	3.3		17.00	7.00	13.50
784 770 904 7	4.7		19.00	6.00	11.00
784 770 906 8	6.8		24.00	5.50	9.00
784 770 910 0	10		30.00	5.00	7.50
784 770 922 0	22		44.00	4.30	5.00
784 770 947 0	47		67.00	3.20	3.50
784 770 910 1	100		120.00	2.20	2.40
784 770 922 1	220		245.00	1.45	1.60
784 770 947 1	470		490.00	0.90	1.10
784 770 910 2	1000		1060	0.63	0.70

Electrical properties: Order Code 784 778

Order Code	Size	L (µH)	R _{DC} (Ω)	I _R (A)	I _{sat} (A)
784 777 010	7332	1	39	3.70	8.00
784 777 022		2.2	61	2.70	5.25
784 777 033		3.3	70	2.50	4.70
784 777 047		4.7	84	2.35	3.70
784 777 068		6.8	98	2.20	3.20
784 777 082		8.2	117	2.00	2.80
784 777 100		10	126	1.90	2.60
784 777 220		22	215	1.40	1.80
784 777 470		47	300	1.15	1.25
784 777 101		100	470	0.72	0.80
784 777 221		220	2720	0.50	0.55
784 777 471		470	5750	0.35	0.38
784 777 102	1000	5760	0.25	0.28	
784 778 010	7345	1	36	3.50	7.00
784 778 022		2.2	50	3.10	5.00
784 778 033		3.3	65	2.65	3.70
784 778 047		4.7	79	2.40	3.10
784 778 068		6.8	107	2.30	2.50
784 778 082		8.2	103	2.20	2.40
784 778 100		10	126	1.85	2.20
784 778 220		22	187	1.55	1.60
784 778 470		47	348	1.10	1.05
784 778 101		100	720	0.72	0.75
784 778 221		220	1620	0.48	0.50
784 778 471		470	3300	0.30	0.35
784 778 102	1000	7200	0.23	0.25	



Design Kit WE-PD2A

SMD Power Inductor

Order Code 784 773 & 784 775, Version 1.1



Characteristics

- Open size
- Current capability up to 14 A
- Operating temperature: -40 °C to +125 °C
- Recommended solder profile: Reflow

Applications

- Switching regulators with low operating voltage (navigation system, air conditioning, entertainment, park assistance control)
- Integrated DC/DC-converter
- Perfectly suitable for switching regulators with extremely high efficiency

Electrical properties: Order Code 784 773

Order Code	Size	L (µH)	R _{DC} (Ω)	I _R (A)	I _{sat} (A)	
784 773 0	4532	1.00	0.014	4.0	5.72	
784 773 018		1.8	0.028	2.70	3.60	
784 773 022		2.2	0.034	2.50	3.38	
784 773 033		3.3	0.041	2.00	2.88	
784 773 039		3.9	0.054	1.88	2.57	
784 773 047		4.7	0.059	1.82	2.46	
784 773 068		6.8	0.076	1.54	2.10	
784 773 10		10	0.118	1.45	1.74	
784 773 112		12	0.156	1.28	1.62	
784 773 115		15	0.204	1.20	1.46	
784 773 118		18	0.225	1.10	1.29	
784 773 122		22	0.261	1.00	1.22	
784 773 127		27	0.328	0.94	1.00	
784 773 133		33	0.370	0.86	0.90	
784 773 147		47	0.523	0.68	0.77	
784 773 168		68	0.754	0.56	0.68	
784 774 022		5848	2.2	0.026	4.60	8.20
784 774 027			2.7	0.032	4.00	8.00
784 774 033			3.3	0.042	3.70	7.50
784 774 047			4.7	0.056	3.00	5.50
784 774 068	6.8		0.071	2.40	5.00	
784 774 10	10		0.078	2.20	2.5	
784 774 112	12		0.082	2.00	1.94	
784 774 115	15		0.089	1.53	1.90	
784 774 118	18		0.104	1.45	1.69	
784 774 122	22		0.109	1.28	1.53	
784 774 127	27		0.133	1.19	1.40	
784 774 133	33		0.150	1.09	1.17	
784 774 147	47		0.260	0.86	1.00	
784 774 156	56		0.298	0.77	0.90	
784 774 168	68		0.313	0.64	0.86	
784 774 182	82		0.475	0.60	0.72	
784 774 20	100		0.510	0.57	0.68	
784 774 215	150		0.720	0.46	0.54	
784 774 222	220		0.945	0.41	0.47	

Electrical properties: Order Code 784 775

Order Code	Size	L (µH)	R _{DC} (Ω)	I _R (A)	I _{sat} (A)	
784 775 10	7850	10	0.040	2.30	2.95	
784 775 112		12	0.042	2.18	2.23	
784 775 115		15	0.044	1.93	2.20	
784 775 118		18	0.053	1.89	2.14	
784 775 122		22	0.065	1.76	1.81	
784 775 127		27	0.074	1.48	1.62	
784 775 133		33	0.130	1.35	1.47	
784 775 139		39	0.116	1.25	1.33	
784 775 147		47	0.134	1.17	1.24	
784 775 168		68	0.218	0.99	1.05	
784 775 182		82	0.248	0.90	0.95	
784 775 20		100	0.281	0.77	0.86	
784 775 215		150	0.467	0.60	0.71	
784 775 218		180	0.574	0.55	0.57	
784 775 222		220	0.614	0.51	0.56	
784 775 227		270	0.699	0.47	0.51	
784 775 239		396	1.151	0.38	0.43	
784 775 247		470	1.370	0.36	0.38	
784 776 10		1054	10	0.028	2.98	3.24
784 776 118			18	0.043	2.36	2.43
784 776 122	22		0.051	2.04	2.07	
784 776 127	27		0.063	1.95	1.98	
784 776 133	33		0.083	1.78	1.89	
784 776 139	39		0.088	1.62	1.80	
784 776 147	47		0.095	1.45	1.62	
784 776 156	56		0.112	1.36	1.53	
784 776 168	68		0.138	1.19	1.49	
784 776 182	82		0.150	1.11	1.17	
784 776 20	100		0.200	1.02	1.10	
784 776 212	120		0.243	0.94	0.99	
784 776 215	150		0.300	0.81	0.90	
784 776 218	180		0.320	0.76	0.78	
784 776 222	220	0.451	0.67	0.77		
784 776 233	330	0.750	0.52	0.59		
784 776 247	470	0.969	0.44	0.50		

Design Kit WE-MAIA

SMD Metal Alloy Power Inductor

Order Code 784 3833 & 784 3832, Version 1.0



Characteristics

- Magnetic iron alloy allows high rated currents
- Compact design
- Magnetically shielded
- High current capability and handles high transient current spikes
- Low acoustic noise and low leakage flux noise
- Operating temperature: $-40\text{ }^{\circ}\text{C}$ to $125\text{ }^{\circ}\text{C}$

Applications

- DC/DC-converter for high current power supplies
- DC/DC-converter for Field Programmable Gate Array (FPGA)
- POL-converters
- Portable power like PDA, digital camera
- Mainboards/graphic cards
- Battery powered devices
- Wireless communication devices
- Power supplies for smartphones, tablet PCs and other mobile devices

Electrical properties: Order Code 784 3833

Order Code	Size	L (μH)	I_R (A)	I_{sat} (A)	R_{DC} (Ω)	
784 383 330 22	3010	2.2	1.4	3.9	150	
784 383 330 33		3.3	1.1	2.95	232	
784 383 330 47		4.7	0.9	2.4	356	
784 383 340 033	3012	0.33	4.8	11.1	19.0	
784 383 340 047		0.47	4.0	9.4	22.0	
784 383 340 056		0.56	3.6	8.5	29.0	
784 383 340 068		0.68	3.5	7.7	36.0	
784 383 340 10		1.0	2.75	6.6	42.1	
784 383 340 12		1.2	2.65	6.0	55.0	
784 383 340 15		1.5	2.0	5.7	80.0	
784 383 340 22		2.2	1.80	5.0	100	
784 383 340 33		3.3	1.4	4.0	156.3	
784 383 340 47		4.7	1.1	3.80	267.7	
784 383 340 56		5.6	1.0	3.0	338.3	
784 383 340 68		6.8	0.88	2.7	368.2	
784 383 350 10		3015	1.0	2.7	4.5	39.0
784 383 350 22			2.2	1.8	3.5	94.0
784 383 350 33			3.3	1.7	3.2	114
784 383 350 47	4.7		1.5	2.8	141	
784 383 350 68	6.8		1.1	2.4	250	
784 383 351 00	10.0		0.85	2.0	446	
784 383 351 50	15.0		0.65	1.71	720	
784 383 352 20	22.0		0.60	1.60	940	
784 383 353 30	33.0		0.50	1.30	1210	
784 383 354 70	47.0		0.39	1.18	2090	

Electrical properties: Order Code 784 3832

Order Code	Size	L (μH)	I_R (A)	I_{sat} (A)	R_{DC} (Ω)
784 383 210 047	2506	0.47	2.2	3.7	76.0
784 383 210 10		1.0	1.25	2.5	163.0
784 383 220 047	2508	0.47	2.25	4.4	70.0
784 383 220 10		1.0	1.75	3.35	107.0
784 383 220 22		2.2	1.34	2.2	252.0
784 383 230 033	2510	0.33	3.4	6.2	29.0
784 383 230 047		0.47	3.2	5.5	37.0
784 383 230 068		0.68	3.1	4.7	46.0
784 383 230 082		0.82	2.6	4.25	53.0
784 383 230 10		1.0	2.5	4.0	63.0
784 383 230 12		1.2	1.9	3.8	82.0
784 383 230 15		1.5	1.8	3.5	92.0
784 383 230 22		2.2	1.3	2.5	147
784 383 230 33		3.3	1.25	2.1	220
784 383 230 47		4.7	0.94	1.75	338
784 383 230 68		6.8	0.85	1.55	563
784 383 230 82		8.2	0.7	1.45	646
784 383 231 00		10.0	0.6	1.35	733

Total Quality Management



Analysis laboratory:

- XRF
- IFR
- Computer Tomography
- Hi Pot Tester up to 10kV
- Network Analyzer
- Oscilloscopes
- Precision LCR
- Source Meter
- Efficiency Measurement
- Twister Thermal Characterisation
- Moisture Balance
- Vision Measuring
- Profile Projector
- DSC
- Precision Magnetics Analyzer
- Hi Pot Tester 6,0kV
- Multiohmmeter
- Stereomicroscope 45x with camera
- Impedance Analyzer
- Reflow Oven
- Stereomicroscope 5000X

- Wetting Balance Machine
- Push and Pull Tester
- Wave Soldering
- DC Bias Measurement System
- Epoxy chamber
- PCB sample boards
- LED Measurement Equipment
- Grinding Machine
- Force Meter
- Mechanical tools
- Vibration up to 50g
- Mechanical Shock up to 100g

Reliability laboratory:

- Glow Wire Tester
- Salt Spray Chamber
- Flammability Tester
- Steamaging Machine
- Temperature Cycling Oven
- Thermal Shock Oven
- Thermal Oven



Cautions and Warnings

General:

All recommendations according to the general technical specifications of the datasheet have to be complied with.

The disposal and operation of the product within ambient conditions which probably alloy or harm the component surface has to be avoided.

If the product is potted in customer applications, the potting material might shrink during and after hardening. Accordingly to this the product is exposed to the pressure of the potting material with the effect that the ferrite body and termination is possibly damaged by this pressure and so the electrical as well as the mechanical characteristics are endanger to be affected. After the potting material is cured, the ferrite body and termination of the product have to be checked if any reduced electrical or mechanical functions or destructions have occurred.

The responsibility for the applicability of customer specific products and use in a particular customer design is always within the authority of the customer. All technical specifications for standard products do also apply for customer specific products.

Washing varnish agent that is used during the production to clean the application might damage or change the characteristics of the plating. The washing varnish agent could have a negative effect on the long term function of the product.

Direct mechanical impact to the product shall be prevented as the ferrite material of the ferrite body could flake or in the worst case it could break.

Product specific:

Follow all instructions mentioned in the datasheet, especially:

- The solder profile has to be complied with according to the technical reflow soldering specification, otherwise no warranty will be sustained.
- Wave soldering is only allowed after evaluation and approval.
- All products are supposed to be used before the end of the period of 12 months based on the product date-code, if not a 100% solderability can't be warranted.
- Violation of the technical product specifications such as exceeding the nominal rated current will result in the loss of warranty.





Information in this catalogue is subject to change. The process of continually improving our product range leads to changes in content. For new designs please refer to our latest data sheets on www.we-online.com or contact our field staff.







Looking for pricing, stock, or lifecycle information?

Click below to explore more details on WIN SOURCE:

-  [View 784774222 on WIN SOURCE](#)
-  [Wurth Electronics Inc Information](#)

Optimize Your Supply Chain with WIN SOURCE Solutions

-  Global Sourcing Solution
-  Obsolete Management
-  Cost Control Management
-  Shortage Management
-  Alternative Solution
-  Excess Inventory Management