



**THE DATASHEET OF  
A1214LLHLT-T**



## Continuous-Time Latch Family

### FEATURES AND BENEFITS

- AEC-Q100 automotive qualified
- Continuous-time operation
  - Fast power-on time
  - Low noise
- Stable operation over full operating temperature range
- Reverse-battery protection
- Solid-state reliability
- Factory-programmed at end-of-line for optimum performance
- Robust EMC performance
- High ESD rating
- Regulator stability without a bypass capacitor

### PACKAGES:

*Not to scale*

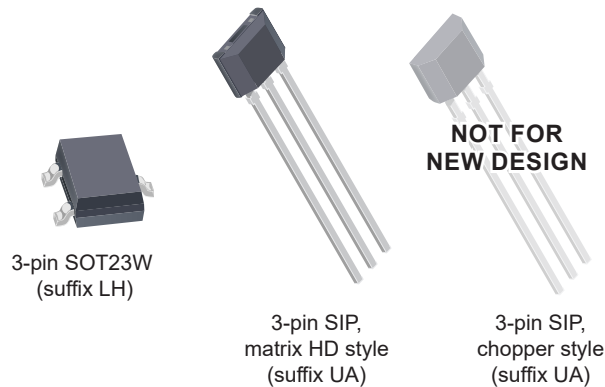

### DESCRIPTION

The Allegro™ A1210-A1214 Hall-effect latches are next generation replacements for the popular Allegro 317x and 318x lines of latching switches. The A121x family, produced with BiCMOS technology, consists of devices that feature fast power-on time and low-noise operation. Device programming is performed after packaging, to ensure increased switch point accuracy by eliminating offsets that can be induced by package stress. Unique Hall element geometries and low-offset amplifiers help to minimize noise and to reduce the residual offset voltage normally caused by device overmolding, temperature excursions, and thermal stress.

The A1210-A1214 Hall-effect latches include the following on a single silicon chip: voltage regulator, Hall-voltage generator, small-signal amplifier, Schmitt trigger, and NMOS output transistor. The integrated voltage regulator permits operation from 3.8 to 24 V. The extensive on-board protection circuitry makes possible a  $\pm 30$  V absolute maximum voltage rating for superior protection in automotive and industrial motor commutation applications, without adding external components. All devices in the family are identical except for magnetic switch point levels.

The small geometries of the BiCMOS process allow these devices to be provided in ultra small packages. The package styles available provide magnetically optimized solutions for most applications. Package LH is an SOT23W, a miniature low-profile surface-mount package, while package UA is a three-lead ultra mini SIP for through-hole mounting. Each package is lead (Pb) free, with 100% matte-tin-plated leadframes.

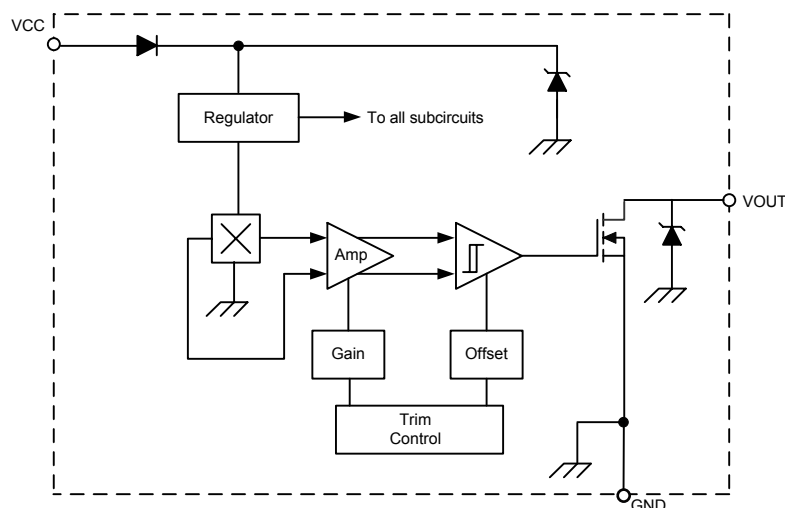

**Functional Block Diagram**

**SPECIFICATIONS**

**SELECTION GUIDE**

Part Number	Packing [1]	Mounting	Ambient, T <sub>A</sub>	B <sub>RP</sub> (Min)	B <sub>OP</sub> (Max)
A1210ELHLT-T	7-in. reel, 3000 pieces/reel	3-pin SOT23W surface mount	-40°C to 85°C	-150 G	150 G
A1210ELHLX-T	13-in. reel, 10000 pieces/reel	3-pin SOT23W surface mount			
A1210LLHLT-T	7-in. reel, 3000 pieces/reel	3-pin SOT23W surface mount	-40°C to 150°C	-150 G	150 G
A1210LLHLX-T	13-in. reel, 10000 pieces/reel	3-pin SOT23W surface mount			
A1210LUA-T [2]	Bulk, 500 pieces/bag	3-pin SIP through hole	-40°C to 150°C	-180 G	180 G
A1211LUA-T [2]	Bulk, 500 pieces/bag	3-pin SIP through hole			
A1212LLHLT-T	7-in. reel, 3000 pieces/reel	3-pin SOT23W surface mount	-40°C to 150°C	-175 G	175 G
A1212LLHLX-T	13-in. reel, 10000 pieces/reel	3-pin SOT23W surface mount			
A1212LUA-T [2]	Bulk, 500 pieces/bag	3-pin SIP through hole	-40°C to 150°C	-200 G	200 G
A1213LLHLT-T	7-in. reel, 3000 pieces/reel	3-pin SOT23W surface mount			
A1213LLHLX-T	13-in. reel, 10000 pieces/reel	3-pin SOT23W surface mount	-40°C to 150°C	-200 G	200 G
A1213LUA-T [2]	Bulk, 500 pieces/bag	3-pin SIP through hole			
A1214LLHLT-T	7-in. reel, 3000 pieces/reel	3-pin SOT23W surface mount	-40°C to 150°C	-300 G	300 G
A1214LLHLX-T	13-in. reel, 10000 pieces/reel	3-pin SOT23W surface mount			
A1214LUA-T [2]	Bulk, 500 pieces/bag	3-pin SIP through hole			



[1] Contact Allegro for additional packing options.

[2] The chopper-style UA package is not for new design; the matrix HD style UA package is recommended for new designs.

**ABSOLUTE MAXIMUM RATINGS**

Characteristic	Symbol	Notes	Rating	Unit
Supply Voltage	V <sub>CC</sub>		30	V
Reverse Supply Voltage	V <sub>RCC</sub>		-30	V
Output Off Voltage	V <sub>OUT</sub>		30	V
Reverse Output Voltage	V <sub>ROUT</sub>		-0.5	V
Output Current	I <sub>OUTSINK</sub>		25	mA
Magnetic Flux Density	B	1 G = 0.1 mT (millitesla)	Unlimited	G
Operating Ambient Temperature	T <sub>A</sub>	Range E	-40 to 85	°C
		Range L	-40 to 150	°C
Maximum Junction Temperature	T <sub>J(max)</sub>		165	°C
Storage Temperature	T <sub>stg</sub>		-65 to 170	°C

## PINOUT DIAGRAMS AND TERMINAL LIST TABLE

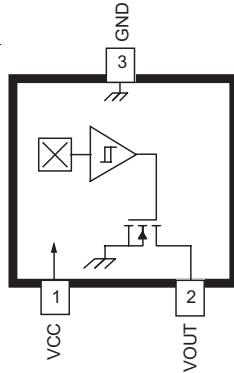

Package LH, 3-Pin SOT23W Pinout Diagram

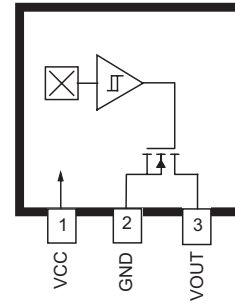

Package UA, 3-Pin SIP Pinout Diagram

### Terminal List

Name	Number		Description
	Package LH	Package UA	
VCC	1	1	Connects power supply to chip
VOUT	2	3	Output from circuit
GND	3	2	Ground

**OPERATING CHARACTERISTICS: Over full operating voltage and ambient temperature ranges, unless otherwise noted**

Characteristic	Symbol	Test Conditions	Min.	Typ.	Max.	Units	
<b>ELECTRICAL CHARACTERISTICS</b>							
Supply Voltage [1]	$V_{CC}$	Operating, $T_J < 165^\circ\text{C}$	3.8	–	24	V	
Output Leakage Current	$I_{OUTOFF}$	$V_{OUT} = 24\text{ V}$ , $B < B_{RP}$	–	–	10	$\mu\text{A}$	
Output On Voltage	$V_{OUT(SAT)}$	$I_{OUT} = 20\text{ mA}$ , $B > B_{OP}$	–	215	400	mV	
Power-On Time [2]	$t_{PO}$	Slew rate ( $dV_{CC}/dt$ ) $< 2.5\text{ V}/\mu\text{s}$ , $B > B_{OP} + 5\text{ G}$ or $B < B_{RP} - 5\text{ G}$	–	–	4	$\mu\text{s}$	
Output Rise Time [3]	$t_r$	$V_{CC} = 12\text{ V}$ , $R_{LOAD} = 820\ \Omega$ , $C_S = 12\text{ pF}$	–	–	400	ns	
Output Fall Time [3]	$t_f$	$V_{CC} = 12\text{ V}$ , $R_{LOAD} = 820\ \Omega$ , $C_S = 12\text{ pF}$	–	–	400	ns	
Supply Current	$I_{CCON}$	$B > B_{OP}$	–	4.1	7.5	mA	
	$I_{CCOFF}$	$B < B_{RP}$	–	3.8	7.5	mA	
Reverse Battery Current	$I_{RCC}$	$V_{RCC} = -30\text{ V}$	–	–	-10	mA	
Supply Zener Clamp Voltage	$V_Z$	$I_{CC} = 10.5\text{ mA}$ ; $T_A = 25^\circ\text{C}$	32	–	–	V	
Supply Zener Current [4]	$I_Z$	$V_Z = 32\text{ V}$ ; $T_A = 25^\circ\text{C}$	–	–	10.5	mA	
<b>MAGNETIC CHARACTERISTICS [5]</b>							
Operate Point	$B_{OP}$	A1210	South pole adjacent to branded face of device	25	78	150	G
		A1211		15	87	180	G
		A1212		50	107	175	G
		A1213		80	–	200	G
		A1214		140	–	300	G
Release Point	$B_{RP}$	A1210	North pole adjacent to branded face of device	-150	-78	-25	G
		A1211		-180	-95	-15	G
		A1212		-175	-117	-50	G
		A1213		-200	–	-80	G
		A1214		-300	–	-140	G
Hysteresis	$B_{HYS}$	A1210	$B_{OP} - B_{RP}$	50	155	–	G
		A1211		80	180	–	G
		A1212		100	225	350	G
		A1213		160	–	400	G
		A1214		280	–	600	G

[1] Maximum voltage must be adjusted for power dissipation and junction temperature, see *Power Derating* section.

[2] For  $V_{CC}$  slew rates greater than  $250\text{ V}/\mu\text{s}$ , and  $T_A = 150^\circ\text{C}$ , the Power-On Time can reach its maximum value.

[3]  $C_S$  = oscilloscope probe capacitance.

[4] Maximum current limit is equal to the maximum  $I_{CC(max)} + 3\text{ mA}$ .

[5] Magnetic flux density, B, is indicated as a negative value for north-polarity magnetic fields, and as a positive value for south-polarity magnetic fields. This so-called algebraic convention supports arithmetic comparison of north and south polarity values, where the relative strength of the field is indicated by the absolute value of B, and the sign indicates the polarity of the field (for example, a  $-100\text{ G}$  field and a  $100\text{ G}$  field have equivalent strength, but opposite polarity).

**DEVICE QUALIFICATION PROGRAM**

Contact Allegro for information.

**EMC (Electromagnetic Compatibility) REQUIREMENTS**

Contact Allegro for information.

**THERMAL CHARACTERISTICS: May require derating at maximum conditions; see application information**

Characteristic	Symbol	Test Conditions	Value	Units
Package Thermal Resistance	$R_{\theta JA}$	Package LH, on single layer, single-sided PCB with copper limited to solder pads	228	$^{\circ}\text{C}/\text{W}$
		Package LH, on single layer, double-sided PCB with 0.926 in <sup>2</sup> copper area	110	$^{\circ}\text{C}/\text{W}$
		Package UA on single layer, single-sided PCB with copper limited to solder pads	165	$^{\circ}\text{C}/\text{W}$

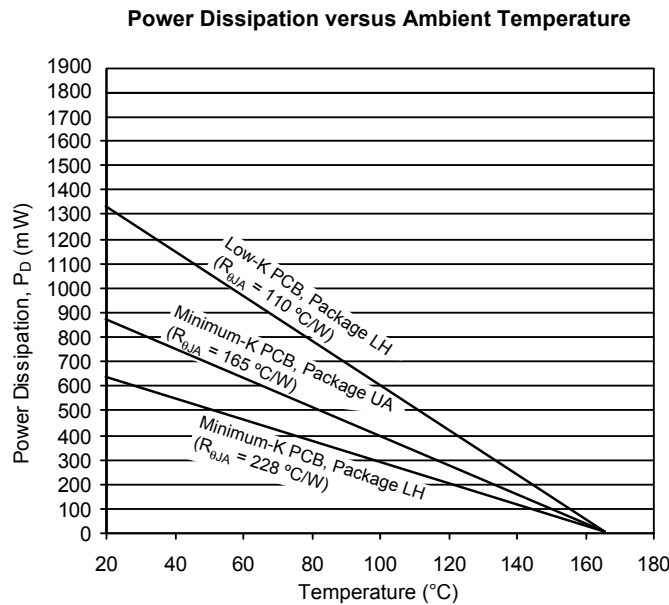
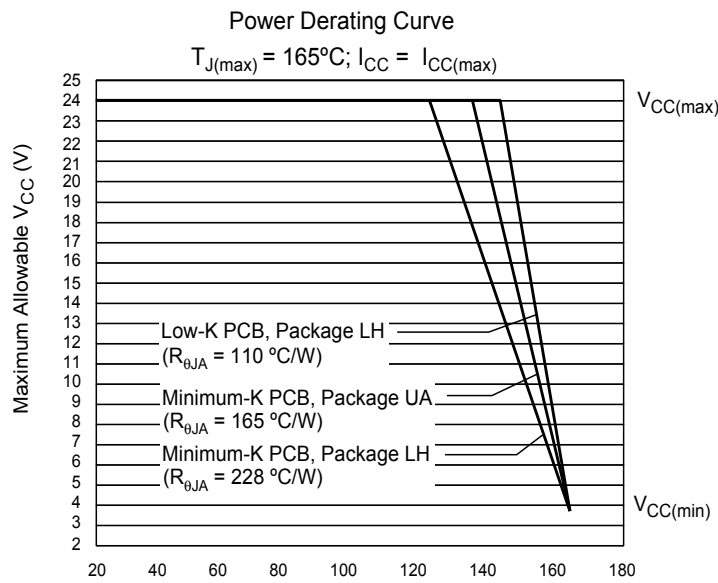

CHARACTERISTIC DATA

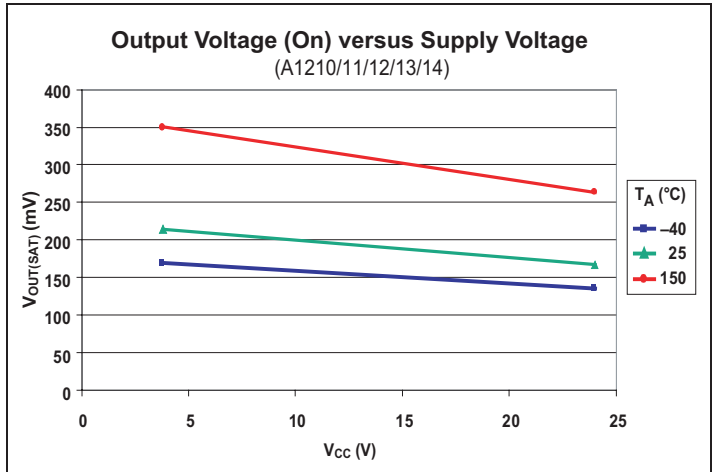
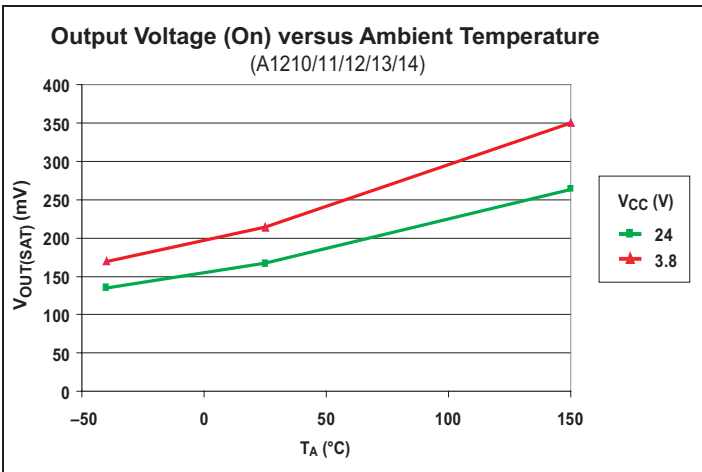
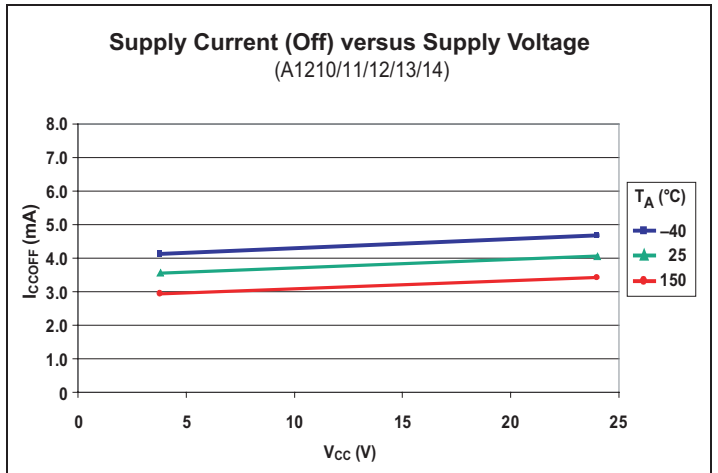
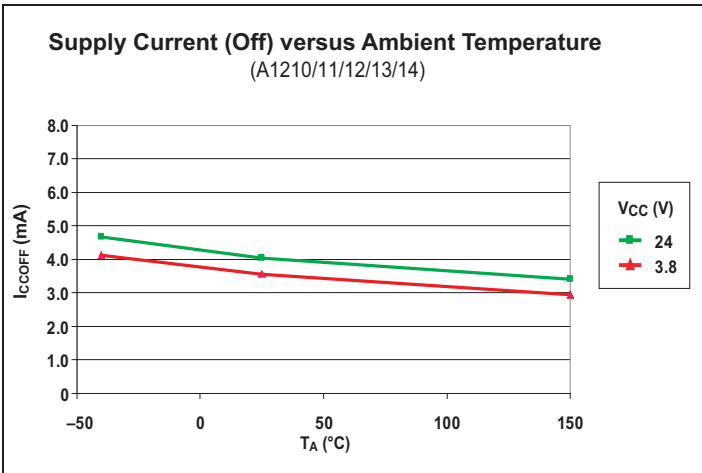
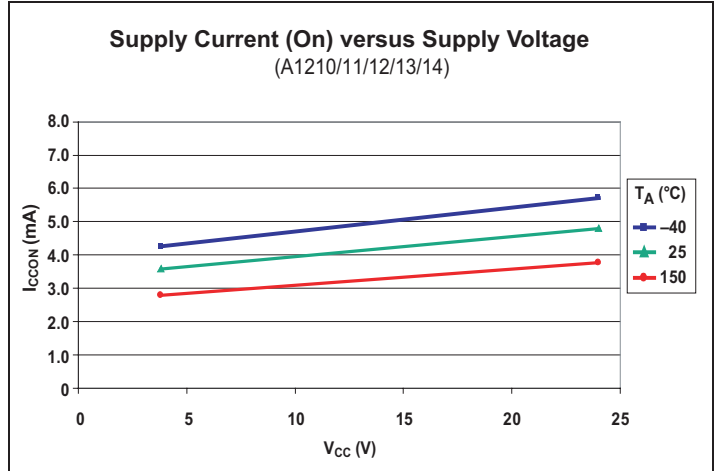
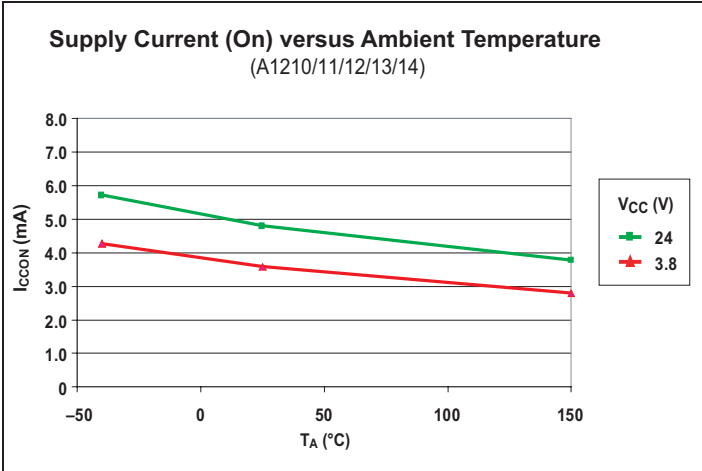

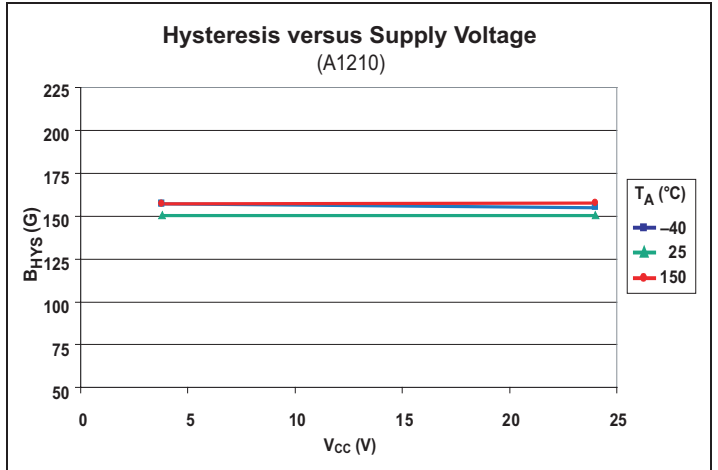
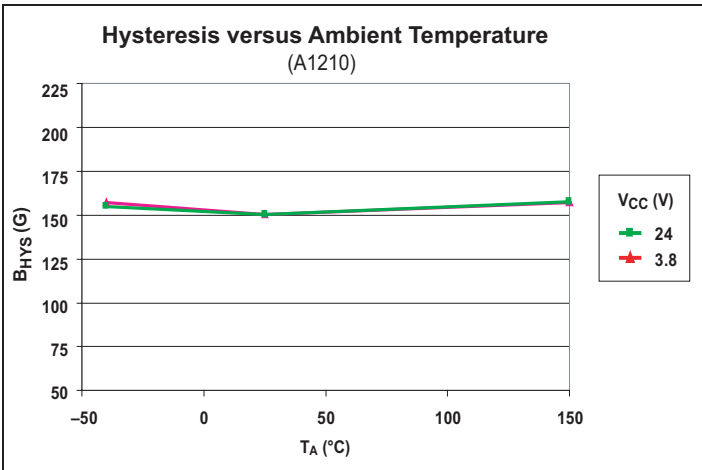
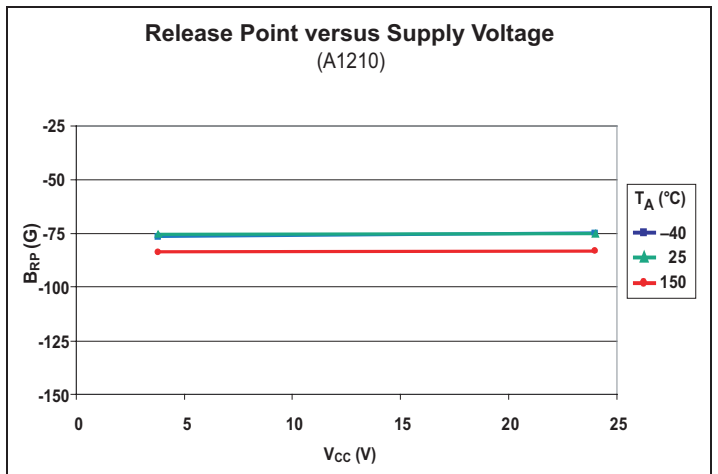
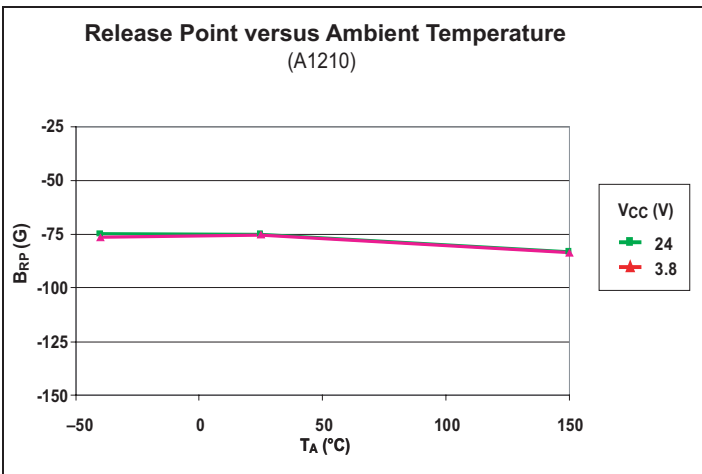
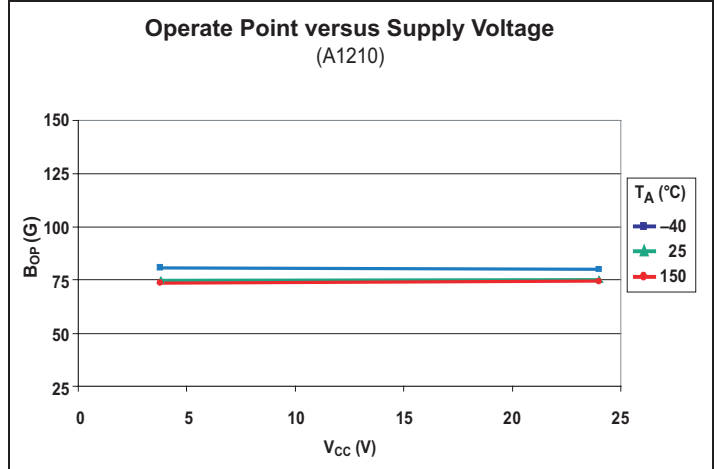
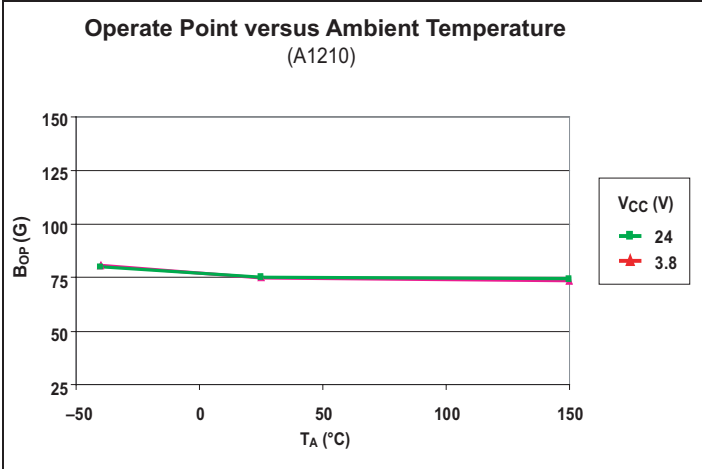

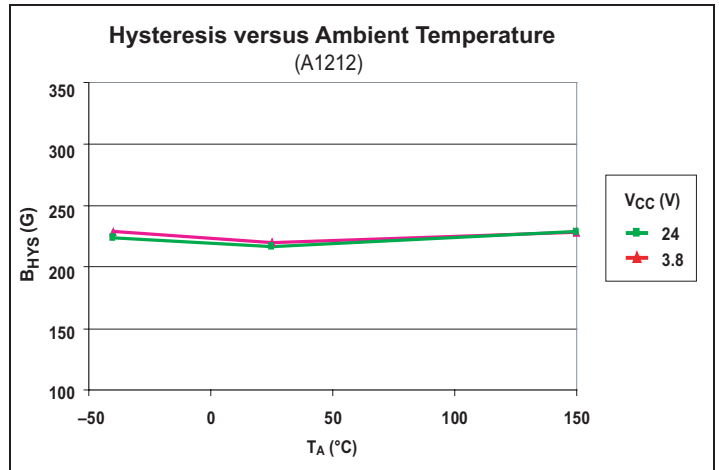
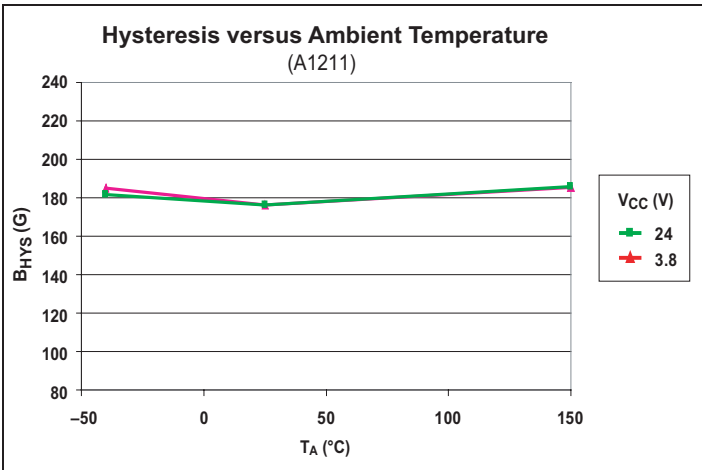
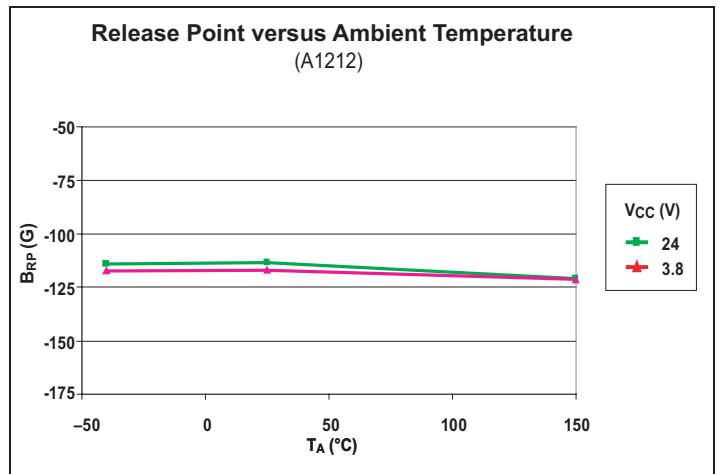
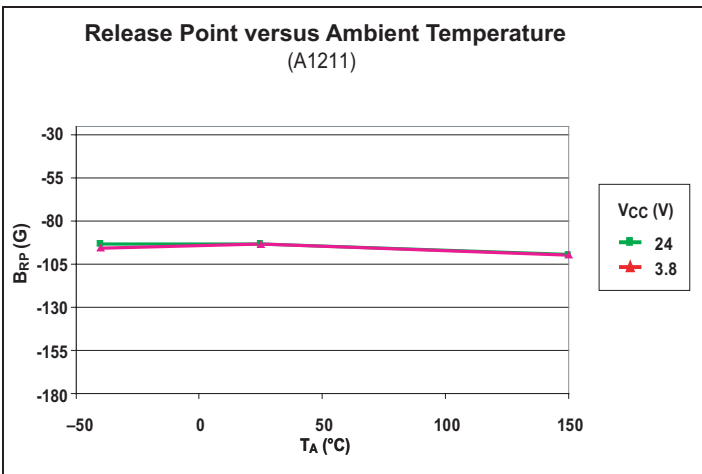
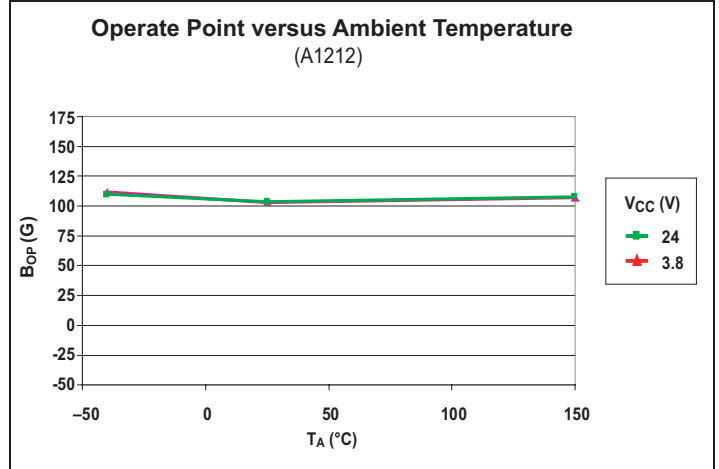
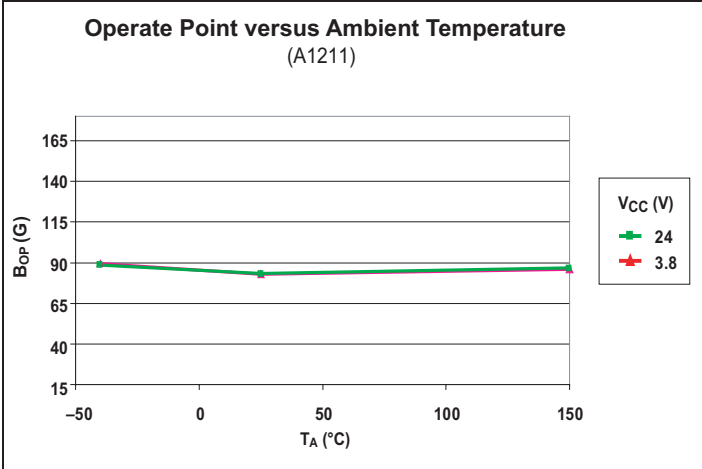

**FUNCTIONAL DESCRIPTION**

**Operation**

The output of these devices switches low (turns on) when a magnetic field perpendicular to the Hall element exceeds the operate point threshold,  $B_{OP}$ . After turn-on, the output is capable of sinking 25 mA and the output voltage is  $V_{OUT(SAT)}$ . Notice that the device latches; that is, a south pole of sufficient strength towards the branded surface of the device turns the device on, and the device remains on with removal of the south pole. When the magnetic field is reduced below the release point,  $B_{RP}$ , the device output goes high (turns off). The difference in the magnetic operate and release points is the hysteresis,  $B_{HYS}$ , of the device. This built-in hysteresis allows clean switching of the output, even in the presence of external mechanical vibration and electrical noise.

Powering-on the device in the hysteresis range, less than  $B_{OP}$  and higher than  $B_{RP}$ , allows an indeterminate output state. The correct state is attained after the first excursion beyond  $B_{OP}$  or  $B_{RP}$ .

**Continuous-Time Benefits**

Continuous-time devices, such as the A121x family, offer the fastest available power-on settling time and frequency response.

Due to offsets generated during the IC packaging process, continuous-time devices typically require programming after packaging to tighten magnetic parameter distributions. In contrast, chopper-stabilized switches employ an offset cancellation technique on the chip that eliminates these offsets without the need for after-packaging programming. The tradeoff is a longer settling time and reduced frequency response as a result of the chopper-stabilization offset cancellation algorithm.

The choice between continuous-time and chopper-stabilized designs is solely determined by the application. Battery management is an example where continuous-time is often required. In these applications,  $V_{CC}$  is chopped with a very small duty cycle in order to conserve power (refer to figure 2). The duty cycle is controlled by the power-on time,  $t_{PO}$ , of the device. Because continuous-time devices have the shorter power-on time, they are the clear choice for such applications.

For more information on the chopper stabilization technique, refer to Technical Paper STP 97-10, *Monolithic Magnetic Hall Sensing Using Dynamic Quadrature Offset Cancellation* and Technical Paper STP 99-1, *Chopper-Stabilized Amplifiers with a Track-and-Hold Signal Demodulator*.

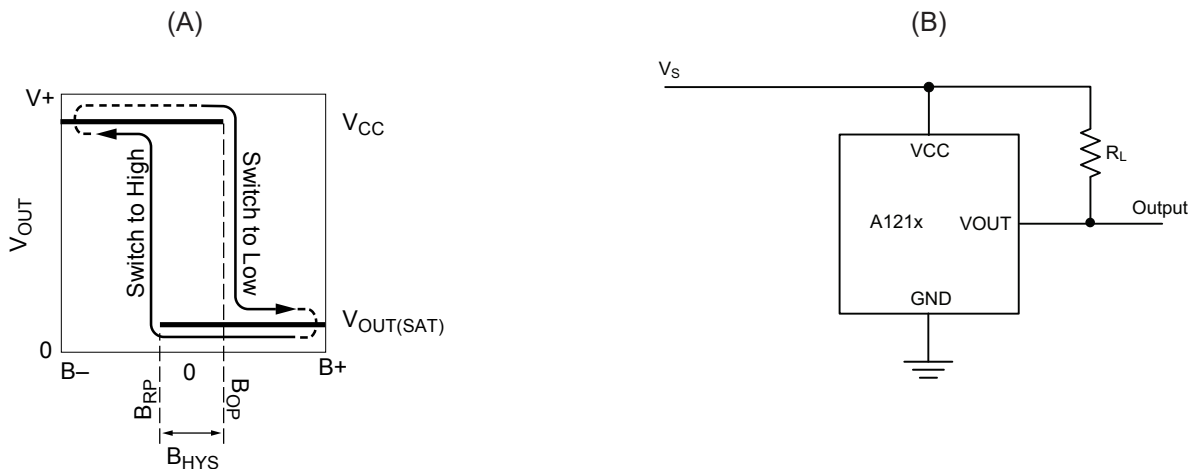

**Figure 1: Switching Behavior of Latches**

On the horizontal axis, the B+ direction indicates increasing south polarity magnetic field strength, and the B- direction indicates decreasing south polarity field strength (including the case of increasing north polarity). This behavior can be exhibited when using a circuit such as that shown in Panel B.

## Additional Application Information

Extensive applications information for Hall-effect devices is available in:

- *Hall-Effect IC Applications Guide*, Application Note 27701
- *Hall-Effect Devices: Gluing, Potting, Encapsulating, Lead Welding and Lead Forming*, Application Note 27703.1
- *Soldering Methods for Allegro's Products – SMT and Through-Hole*, Application Note 26009

All are provided on the Allegro website, [www.allegromicro.com](http://www.allegromicro.com).

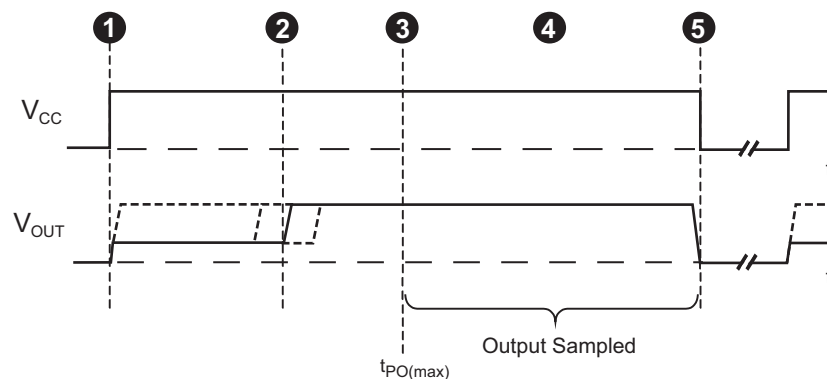

**Figure 2: Continuous-Time Application,  $B < B_{RP}$**

This figure illustrates the use of a quick cycle for chopping  $V_{CC}$  in order to conserve battery power. Position 1, power is applied to the device. Position 2, the output assumes the correct state at a time prior to the maximum Power-On Time,  $t_{PO(max)}$ . The case shown is where the correct output state is HIGH. Position 3,  $t_{PO(max)}$  has elapsed. The device output is valid. Position 4, after the output is valid, a control unit reads the output. Position 5, power is removed from the device.

## POWER DERATING

### Power Derating

The device must be operated below the maximum junction temperature of the device,  $T_{J(max)}$ . Under certain combinations of peak conditions, reliable operation may require derating supplied power or improving the heat dissipation properties of the application. This section presents a procedure for correlating factors affecting operating  $T_J$ . (Thermal data is also available on the Allegro MicroSystems Web site.)

The Package Thermal Resistance,  $R_{\theta JA}$ , is a figure of merit summarizing the ability of the application and the device to dissipate heat from the junction (die), through all paths to the ambient air. Its primary component is the Effective Thermal Conductivity,  $K$ , of the printed circuit board, including adjacent devices and traces. Radiation from the die through the device case,  $R_{\theta JC}$ , is relatively small component of  $R_{\theta JA}$ . Ambient air temperature,  $T_A$ , and air motion are significant external factors, damped by overmolding.

The effect of varying power levels (Power Dissipation,  $P_D$ ), can be estimated. The following formulas represent the fundamental relationships used to estimate  $T_J$ , at  $P_D$ .

$$P_D = V_{IN} \times I_{IN} \quad (1)$$

$$\Delta T = P_D \times R_{\theta JA} \quad (2)$$

$$T_J = T_A + \Delta T \quad (3)$$

For example, given common conditions such as:  $T_A = 25^\circ\text{C}$ ,  $V_{CC} = 12\text{ V}$ ,  $I_{CC} = 4\text{ mA}$ , and  $R_{\theta JA} = 140^\circ\text{C/W}$ , then:

$$P_D = V_{CC} \times I_{CC} = 12\text{ V} \times 4\text{ mA} = 48\text{ mW}$$

$$\Delta T = P_D \times R_{\theta JA} = 48\text{ mW} \times 140^\circ\text{C/W} = 7^\circ\text{C}$$

$$T_J = T_A + \Delta T = 25^\circ\text{C} + 7^\circ\text{C} = 32^\circ\text{C}$$

A worst-case estimate,  $P_{D(max)}$ , represents the maximum allowable power level ( $V_{CC(max)}$ ,  $I_{CC(max)}$ ), without exceeding  $T_{J(max)}$ , at a selected  $R_{\theta JA}$  and  $T_A$ .

*Example:* Reliability for  $V_{CC}$  at  $T_A = 150^\circ\text{C}$ , package UA, using minimum-K PCB.

Observe the worst-case ratings for the device, specifically:  $R_{\theta JA} = 165^\circ\text{C/W}$ ,  $T_{J(max)} = 165^\circ\text{C}$ ,  $V_{CC(max)} = 24\text{ V}$ , and  $I_{CC(max)} = 7.5\text{ mA}$ .

Calculate the maximum allowable power level,  $P_{D(max)}$ . First, invert equation 3:

$$\Delta T_{max} = T_{J(max)} - T_A = 165^\circ\text{C} - 150^\circ\text{C} = 15^\circ\text{C}$$

This provides the allowable increase to  $T_J$  resulting from internal power dissipation. Then, invert equation 2:

$$P_{D(max)} = \Delta T_{max} \div R_{\theta JA} = 15^\circ\text{C} \div 165^\circ\text{C/W} = 91\text{ mW}$$

Finally, invert equation 1 with respect to voltage:

$$V_{CC(est)} = P_{D(max)} \div I_{CC(max)} = 91\text{ mW} \div 7.5\text{ mA} = 12.1\text{ V}$$

The result indicates that, at  $T_A$ , the application and device can dissipate adequate amounts of heat at voltages  $\leq V_{CC(est)}$ .

Compare  $V_{CC(est)}$  to  $V_{CC(max)}$ . If  $V_{CC(est)} \leq V_{CC(max)}$ , then reliable operation between  $V_{CC(est)}$  and  $V_{CC(max)}$  requires enhanced  $R_{\theta JA}$ . If  $V_{CC(est)} \geq V_{CC(max)}$ , then operation between  $V_{CC(est)}$  and  $V_{CC(max)}$  is reliable under these conditions.

PACKAGE OUTLINE DRAWINGS

For Reference Only – Not for Tooling Use

(Reference Allegro DWG-0000628, Rev. 1)  
Dimensions in millimeters – NOT TO SCALE  
Dimensions exclusive of mold flash, gate burrs, and dambar protrusions  
Exact case and lead configuration at supplier discretion within limits shown

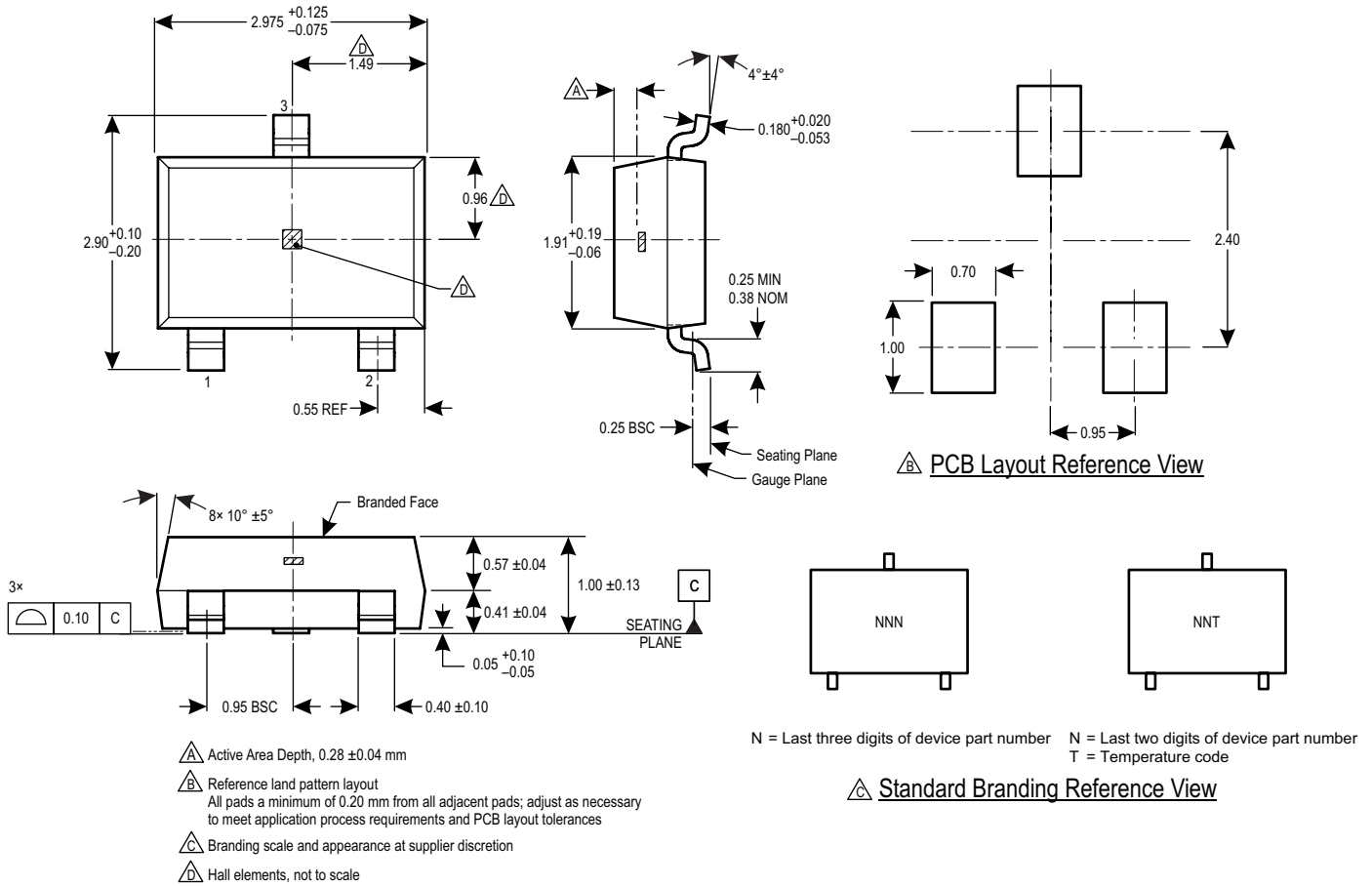

Figure 3: Package LH, 3-Pin SOT-23W

**For Reference Only – Not For Tooling Use**

(Reference Allegro DWG-0000404, Rev. 1)  
NOT TO SCALE

Dimensions in millimeters

Exact case and lead configuration at supplier discretion within limits shown

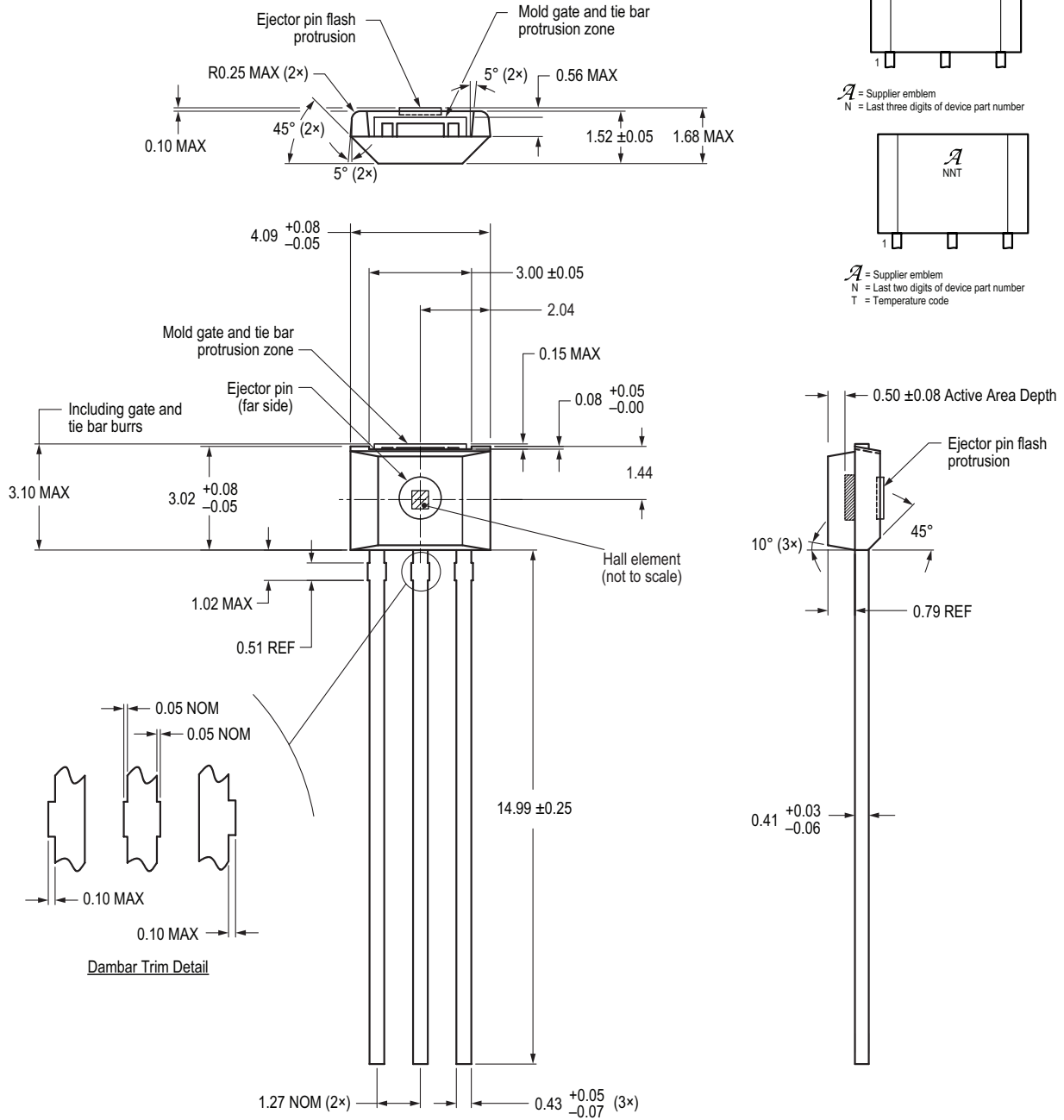

**Figure 4: Package UA, 3-Pin SIP, Matrix Style**

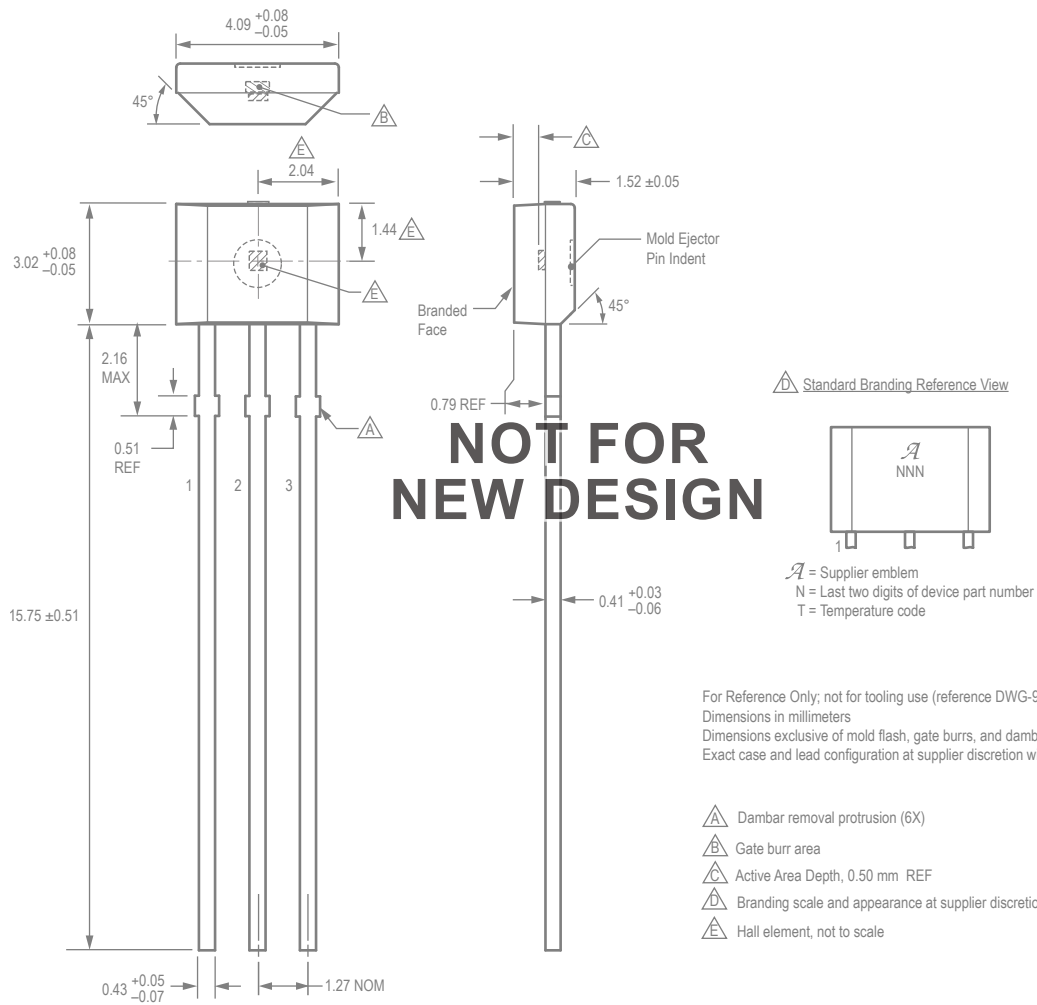

Figure 5: Package UA, 3-Pin SIP, Chopper Style

## Revision History

Number	Date	Description
10	May 29, 2012	Update UA package drawing
11	August 20, 2014	Revised Selection Guide, reformatted datasheet
12	January 1, 2015	Added LX option to Selection Guide
13	September 22, 2015	Corrected LH package Active Area Depth value; added AEC-Q100 qualification under Features and Benefits
14	November 4, 2016	Chopper-style UA package designated as not for new design
15	February 4, 2019	Updated Active Area Depth for UA matrix-style package, and minor editorial updates
16	February 12, 2020	Minor editorial updates
17	December 13, 2021	Updated package drawings and minor editorial updates

Copyright 2021, Allegro MicroSystems.

Allegro MicroSystems reserves the right to make, from time to time, such departures from the detail specifications as may be required to permit improvements in the performance, reliability, or manufacturability of its products. Before placing an order, the user is cautioned to verify that the information being relied upon is current.

Allegro's products are not to be used in any devices or systems, including but not limited to life support devices or systems, in which a failure of Allegro's product can reasonably be expected to cause bodily harm.

The information included herein is believed to be accurate and reliable. However, Allegro MicroSystems assumes no responsibility for its use; nor for any infringement of patents or other rights of third parties which may result from its use.

Copies of this document are considered uncontrolled documents.

*For the latest version of this document, visit our website:*

[www.allegromicro.com](http://www.allegromicro.com)

## Looking for pricing, stock, or lifecycle information?

Click below to explore more details on WIN SOURCE:

- ⊖ [View A1214LLHLT-T on WIN SOURCE](#)
- ⊖ [Allegro MicroSystems, LLC Information](#)

## Optimize Your Supply Chain with WIN SOURCE Solutions

- ✓ Global Sourcing Solution
- ✓ Obsolete Management
- ✓ Cost Control Management
- ✓ Shortage Management
- ✓ Alternative Solution
- ✓ Excess Inventory Management