



**THE DATASHEET OF  
BCW72LT1G**



# BCW72LT1G, SBCW72LT1G

## General Purpose Transistor

### NPN Silicon

#### Features

- S Prefix for Automotive and Other Applications Requiring Unique Site and Control Change Requirements; AEC-Q101 Qualified and PPAP Capable
- These Devices are Pb-Free, Halogen Free/BFR Free and are RoHS Compliant

#### MAXIMUM RATINGS

Rating	Symbol	Value	Unit
Collector–Emitter Voltage	$V_{CEO}$	45	Vdc
Collector–Base Voltage	$V_{CBO}$	50	Vdc
Emitter–Base Voltage	$V_{EBO}$	5.0	Vdc
Collector Current – Continuous	$I_C$	100	mAdc

#### THERMAL CHARACTERISTICS

Characteristic	Symbol	Max	Unit
Total Device Dissipation FR-5 Board, (Note 1) $T_A = 25^\circ\text{C}$ Derate above $25^\circ\text{C}$	$P_D$	225 1.8	mW mW/ $^\circ\text{C}$
Thermal Resistance, Junction-to-Ambient	$R_{\theta JA}$	556	$^\circ\text{C}/\text{W}$
Total Device Dissipation Alumina Substrate, (Note 2) $T_A = 25^\circ\text{C}$ Derate above $25^\circ\text{C}$	$P_D$	300 2.4	mW mW/ $^\circ\text{C}$
Thermal Resistance, Junction-to-Ambient	$R_{\theta JA}$	417	$^\circ\text{C}/\text{W}$
Junction and Storage Temperature	$T_J, T_{stg}$	-55 to +150	$^\circ\text{C}$

Stresses exceeding those listed in the Maximum Ratings table may damage the device. If any of these limits are exceeded, device functionality should not be assumed, damage may occur and reliability may be affected.

1. FR-5 = 1.0 x 0.75 x 0.062 in.
2. Alumina = 0.4 x 0.3 x 0.024 in. 99.5% alumina.



ON Semiconductor®

[www.onsemi.com](http://www.onsemi.com)

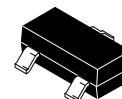

SOT-23  
(TO-236)  
CASE 318-08  
STYLE 6

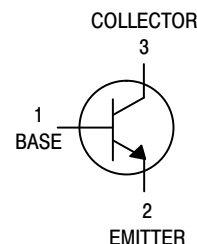

#### MARKING DIAGRAM

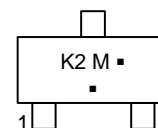

K2 = Device Code  
M = Date Code\*  
■ = Pb-Free Package

(Note: Microdot may be in either location)

\*Date Code orientation and/or overbar may vary depending upon manufacturing location.

#### ORDERING INFORMATION

Device	Package	Shipping†
BCW72LT1G	SOT-23 (Pb-Free)	3,000 / Tape & Reel
SBCW72LT1G	SOT-23 (Pb-Free)	3,000 / Tape & Reel

†For information on tape and reel specifications, including part orientation and tape sizes, please refer to our Tape and Reel Packaging Specifications Brochure, BRD8011/D.

# BCW72LT1G, SBCW72LT1G

## ELECTRICAL CHARACTERISTICS ( $T_A = 25^\circ\text{C}$ unless otherwise noted)

Characteristic	Symbol	Min	Typ	Max	Unit
<b>OFF CHARACTERISTICS</b>					
Collector–Emitter Breakdown Voltage ( $I_C = 2.0\text{ mAdc}$ , $V_{EB} = 0$ )	$V_{(BR)CEO}$	45	–	–	Vdc
Collector–Emitter Breakdown Voltage ( $I_C = 2.0\text{ mAdc}$ , $V_{EB} = 0$ )	$V_{(BR)CES}$	45	–	–	Vdc
Collector–Base Breakdown Voltage ( $I_C = 10\text{ }\mu\text{Adc}$ , $I_E = 0$ )	$V_{(BR)CBO}$	50	–	–	Vdc
Emitter–Base Breakdown Voltage ( $I_E = 10\text{ }\mu\text{Adc}$ , $I_C = 0$ )	$V_{(BR)EBO}$	5.0	–	–	Vdc
Collector Cutoff Current ( $V_{CB} = 20\text{ Vdc}$ , $I_E = 0$ ) ( $V_{CB} = 20\text{ Vdc}$ , $I_E = 0$ , $T_A = 100^\circ\text{C}$ )	$I_{CBO}$	–	–	100 10	nAdc $\mu\text{Adc}$
<b>ON CHARACTERISTICS</b>					
DC Current Gain ( $I_C = 2.0\text{ mAdc}$ , $V_{CE} = 5.0\text{ Vdc}$ )	$h_{FE}$	200	–	450	–
Collector–Emitter Saturation Voltage ( $I_C = 10\text{ mAdc}$ , $I_B = 0.5\text{ mAdc}$ ) ( $I_C = 50\text{ mAdc}$ , $I_B = 2.5\text{ mAdc}$ )	$V_{CE(sat)}$	– –	– 0.21	0.25 –	Vdc
Base–Emitter Saturation Voltage ( $I_C = 50\text{ mAdc}$ , $I_B = 2.5\text{ mAdc}$ )	$V_{BE(sat)}$	–	0.85	–	Vdc
Base–Emitter On Voltage ( $I_C = 2.0\text{ mAdc}$ , $V_{CE} = 5.0\text{ Vdc}$ )	$V_{BE(on)}$	0.6	–	0.75	Vdc
<b>SMALL– SIGNAL CHARACTERISTICS</b>					
Current–Gain – Bandwidth Product ( $I_C = 10\text{ mAdc}$ , $V_{CE} = 5.0\text{ Vdc}$ , $f = 100\text{ MHz}$ )	$f_T$	–	300	–	MHz
Output Capacitance ( $I_E = 0$ , $V_{CB} = 10\text{ Vdc}$ , $f = 1.0\text{ MHz}$ )	$C_{obo}$	–	–	4.0	pF
Input Capacitance ( $I_E = 0$ , $V_{CB} = 10\text{ Vdc}$ , $f = 1.0\text{ MHz}$ )	$C_{ibo}$	–	9.0	–	pF
Noise Figure ( $I_C = 0.2\text{ mAdc}$ , $V_{CE} = 5.0\text{ Vdc}$ , $R_S = 2.0\text{ k}\Omega$ , $f = 1.0\text{ kHz}$ , $BW = 200\text{ Hz}$ )	NF	–	–	10	dB

Product parametric performance is indicated in the Electrical Characteristics for the listed test conditions, unless otherwise noted. Product performance may not be indicated by the Electrical Characteristics if operated under different conditions.

## EQUIVALENT SWITCHING TIME TEST CIRCUITS

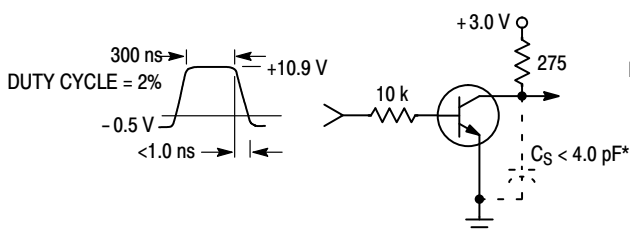

Figure 1. Turn–On Time

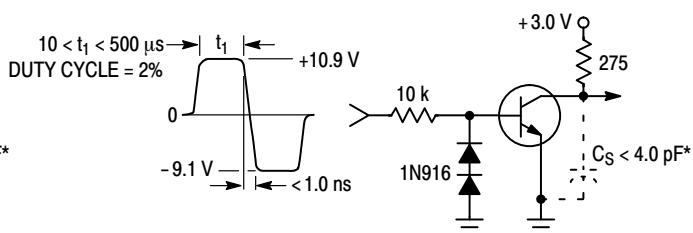

Figure 2. Turn–Off Time

\*Total shunt capacitance of test jig and connectors

# BCW72LT1G, SBCW72LT1G

## TYPICAL NOISE CHARACTERISTICS

( $V_{CE} = 5.0 \text{ Vdc}$ ,  $T_A = 25^\circ\text{C}$ )

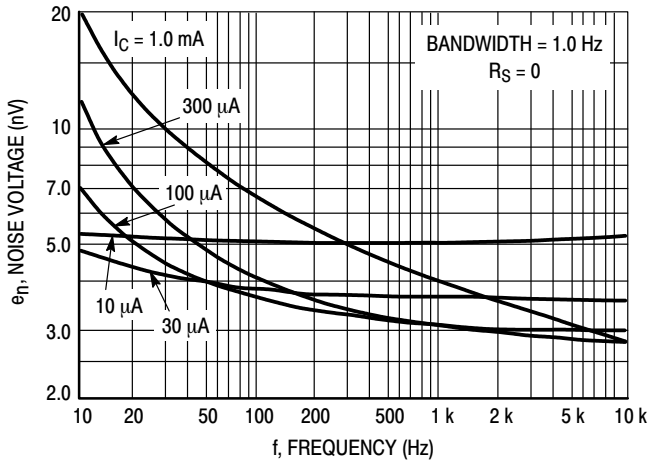

Figure 3. Noise Voltage

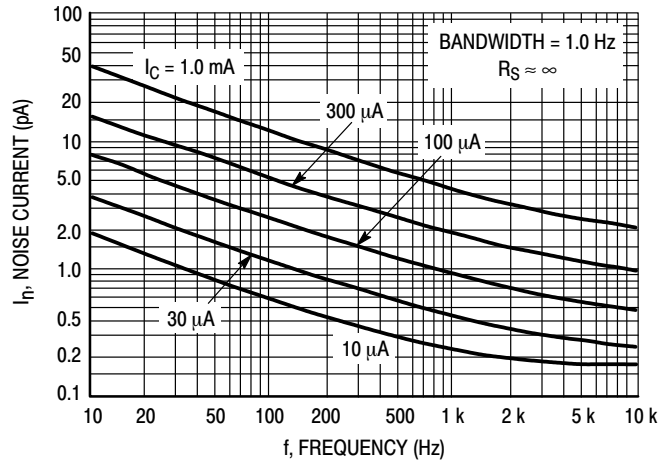

Figure 4. Noise Current

## NOISE FIGURE CONTOURS

( $V_{CE} = 5.0 \text{ Vdc}$ ,  $T_A = 25^\circ\text{C}$ )

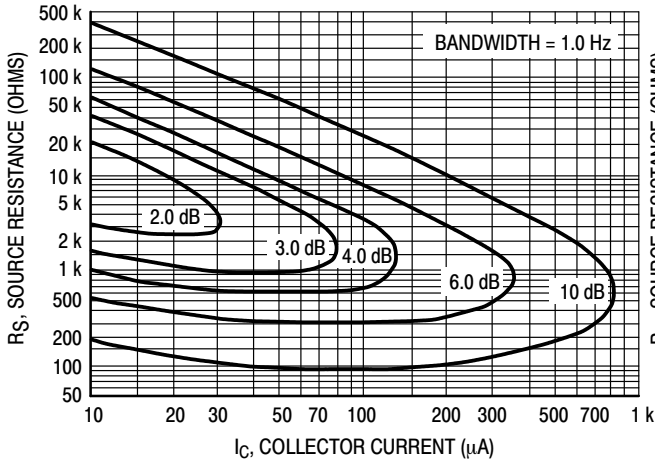

Figure 5. Narrow Band, 100 Hz

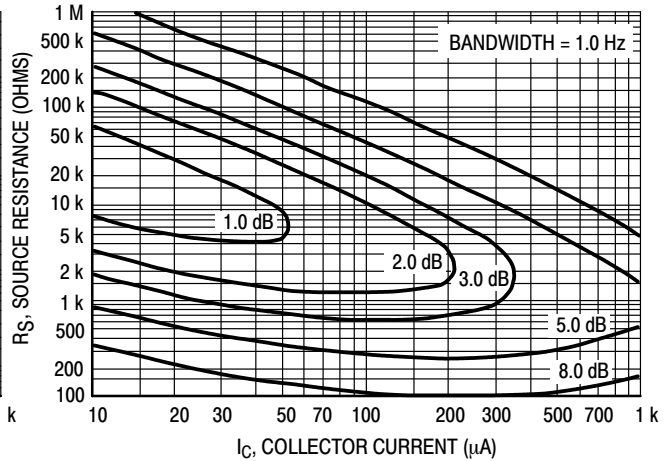

Figure 6. Narrow Band, 1.0 kHz

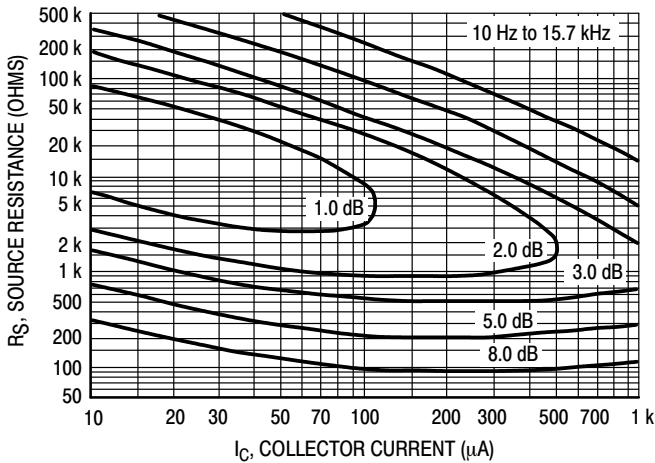

Figure 7. Wideband

Noise Figure is defined as:

$$NF = 20 \log_{10} \left( \frac{e_n^2 + 4KTR_S + I_n^2 R_S^2}{4KTR_S} \right)^{1/2}$$

- $e_n$  = Noise Voltage of the Transistor referred to the input. (Figure 3)
- $I_n$  = Noise Current of the Transistor referred to the input. (Figure 4)
- $K$  = Boltzman's Constant ( $1.38 \times 10^{-23} \text{ J}^\circ\text{K}$ )
- $T$  = Temperature of the Source Resistance ( $^\circ\text{K}$ )
- $R_S$  = Source Resistance (Ohms)

# BCW72LT1G, SBCW72LT1G

## TYPICAL STATIC CHARACTERISTICS

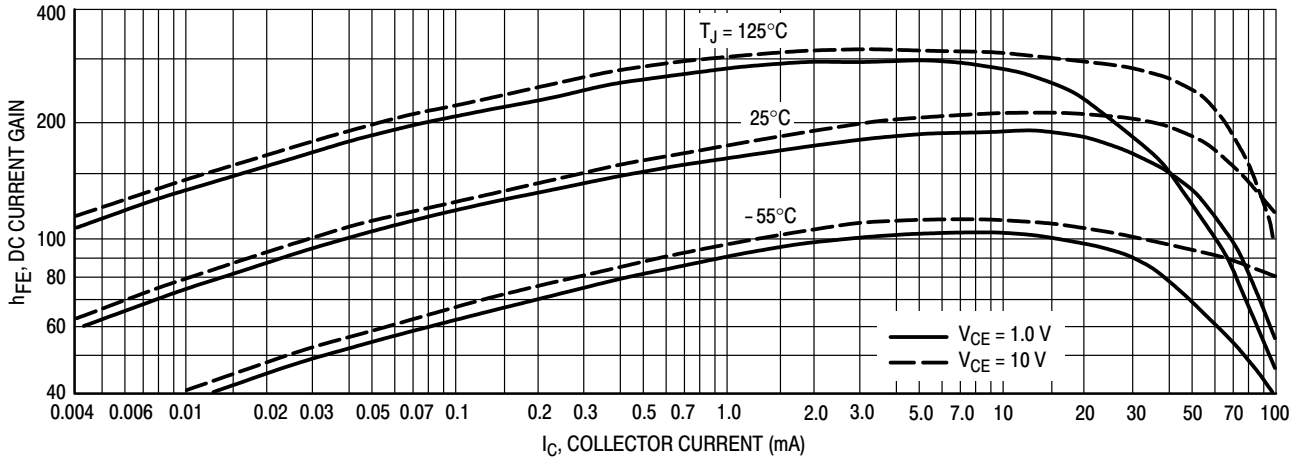

Figure 8. DC Current Gain

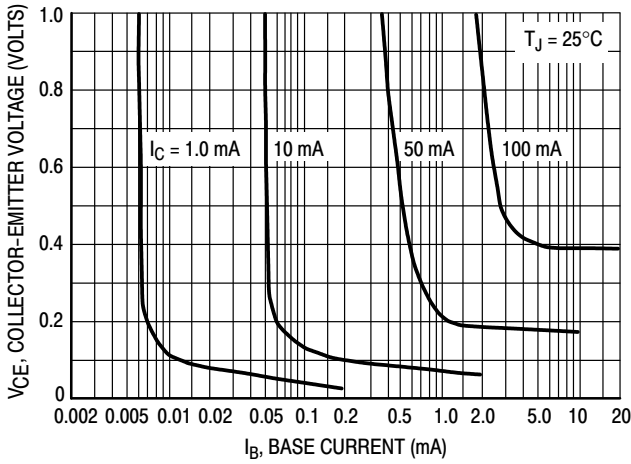

Figure 9. Collector Saturation Region

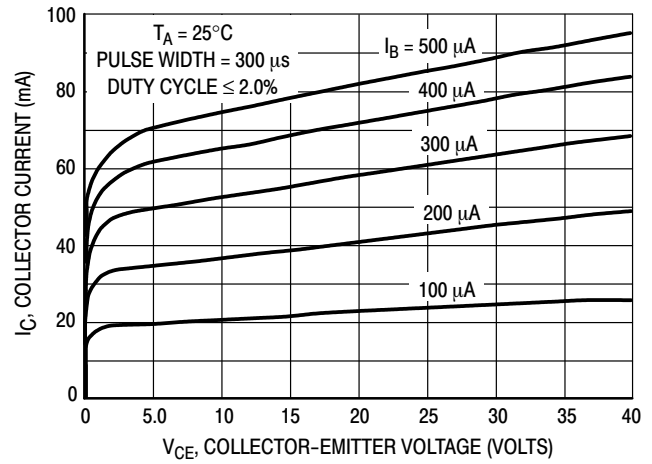

Figure 10. Collector Characteristics

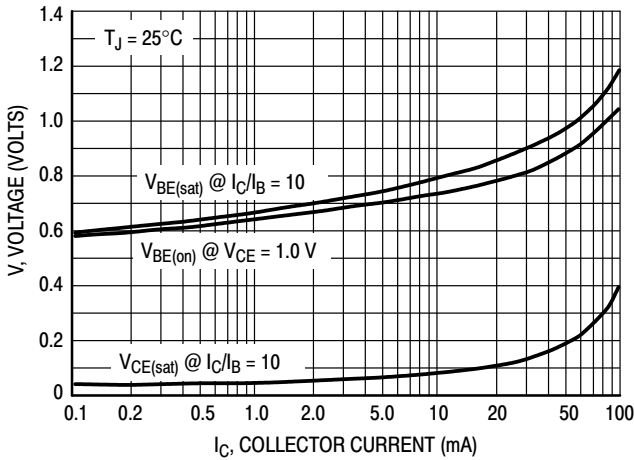

Figure 11. "On" Voltages

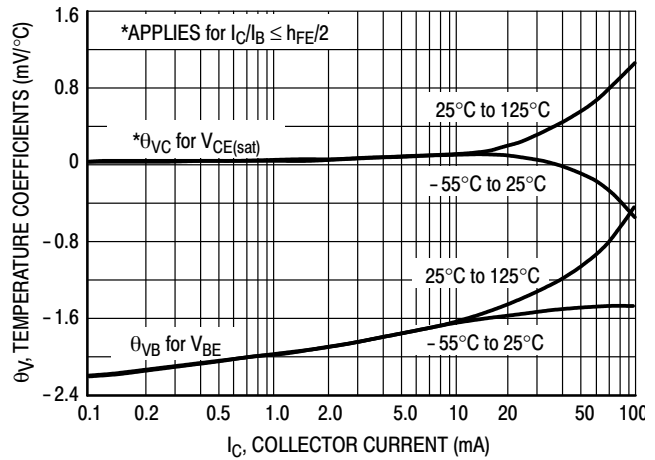

Figure 12. Temperature Coefficients

# BCW72LT1G, SBCW72LT1G

## TYPICAL DYNAMIC CHARACTERISTICS

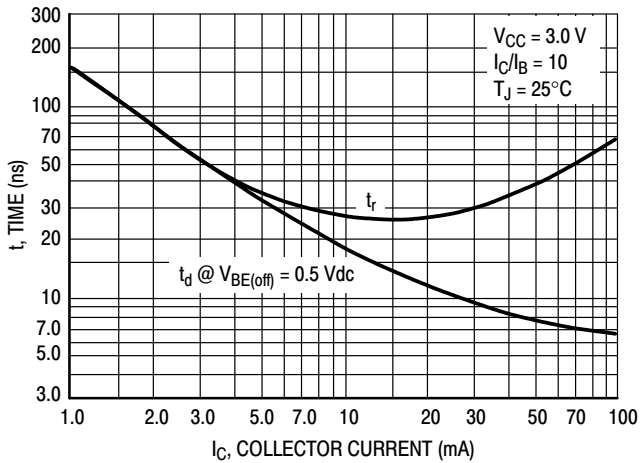

Figure 13. Turn-On Time

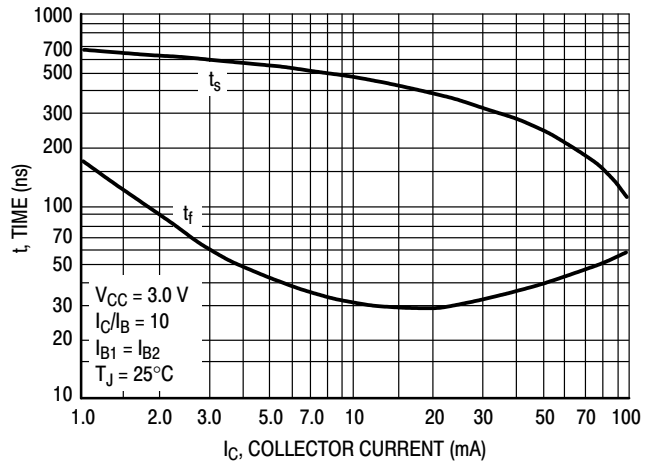

Figure 14. Turn-Off Time

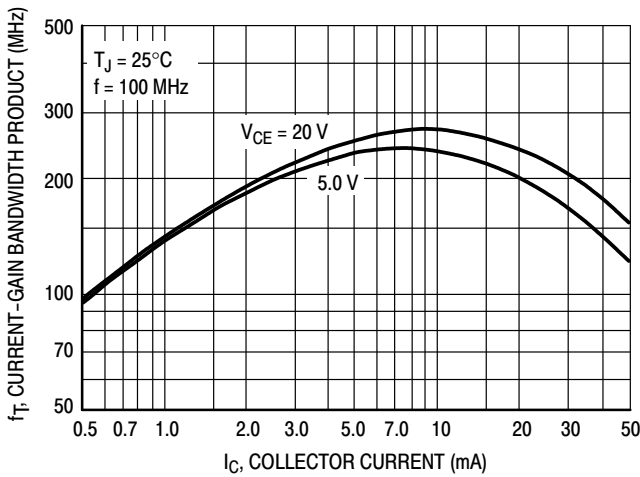

Figure 15. Current-Gain — Bandwidth Product

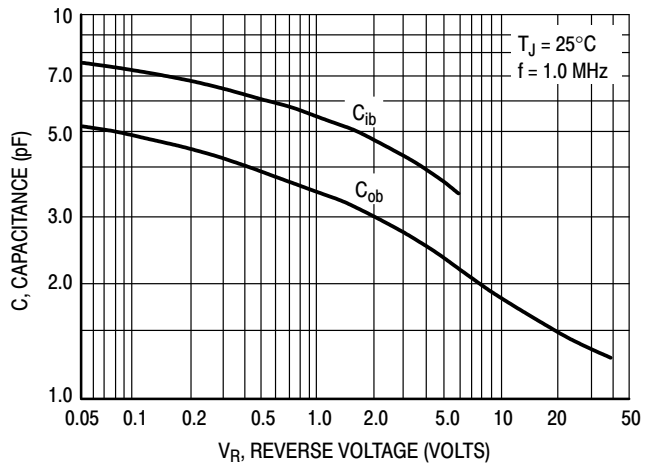

Figure 16. Capacitance

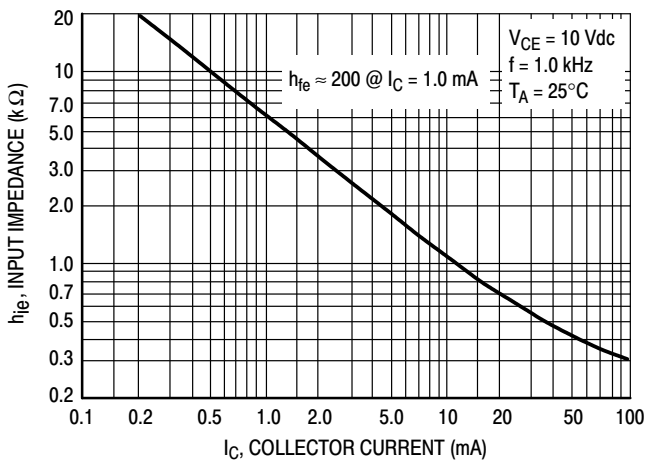

Figure 17. Input Impedance

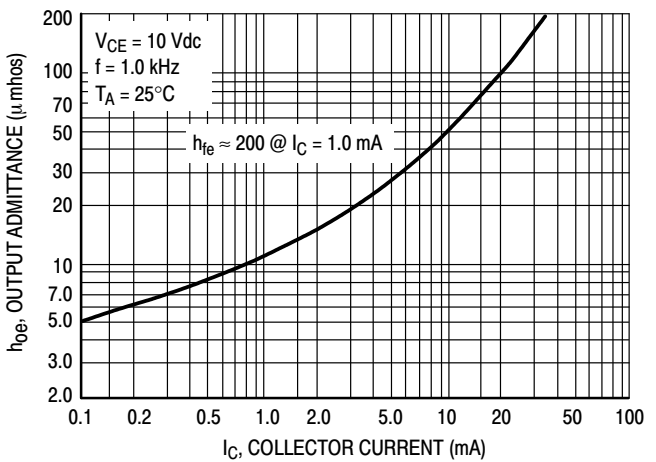

Figure 18. Output Admittance

# BCW72LT1G, SBCW72LT1G

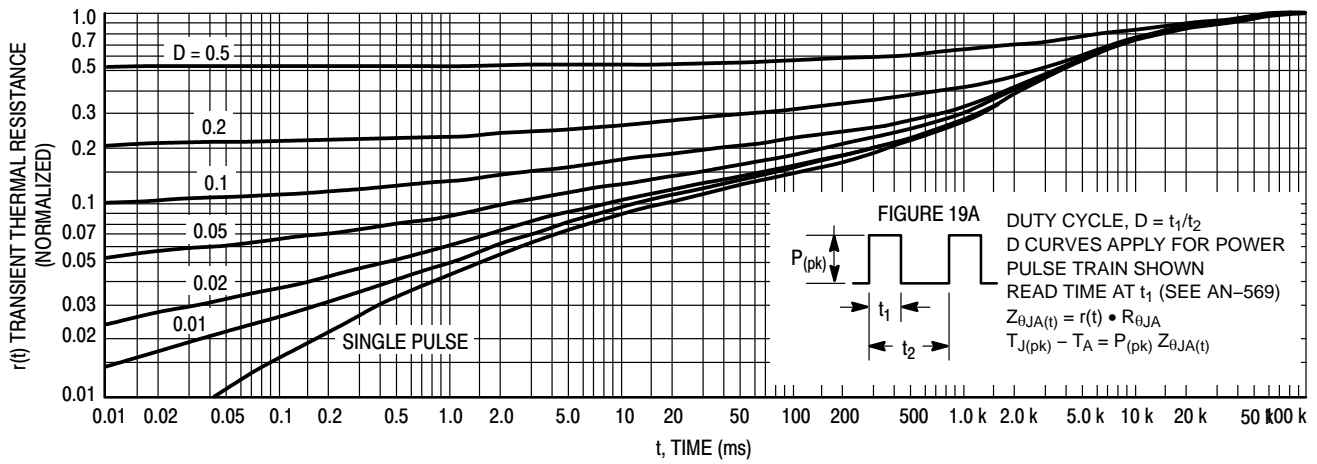

Figure 19. Thermal Response

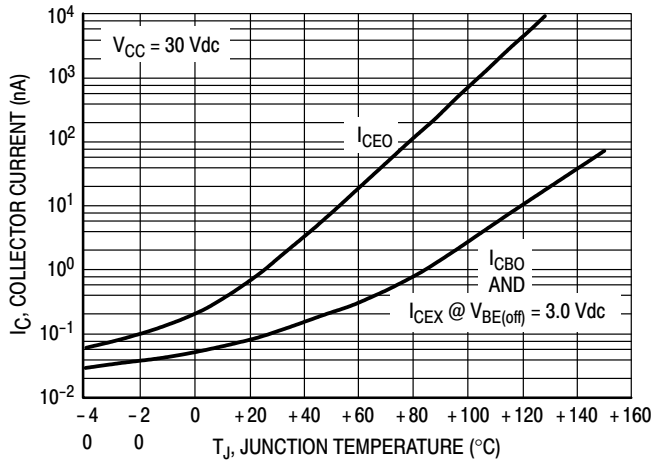

Figure 19A.

### DESIGN NOTE: USE OF THERMAL RESPONSE DATA

A train of periodical power pulses can be represented by the model as shown in Figure 19A. Using the model and the device thermal response the normalized effective transient thermal resistance of Figure 19 was calculated for various duty cycles.

To find  $Z_{\theta JA}(t)$ , multiply the value obtained from Figure 19 by the steady state value  $R_{\theta JA}$ .

Example:

The MPS3904 is dissipating 2.0 watts peak under the following conditions:

$$t_1 = 1.0 \text{ ms}, t_2 = 5.0 \text{ ms}. (D = 0.2)$$

Using Figure 19 at a pulse width of 1.0 ms and  $D = 0.2$ , the reading of  $r(t)$  is 0.22.

The peak rise in junction temperature is therefore

$$\Delta T = r(t) \times P_{(pk)} \times R_{\theta JA} = 0.22 \times 2.0 \times 200 = 88^\circ\text{C}.$$

For more information, see AN-569.

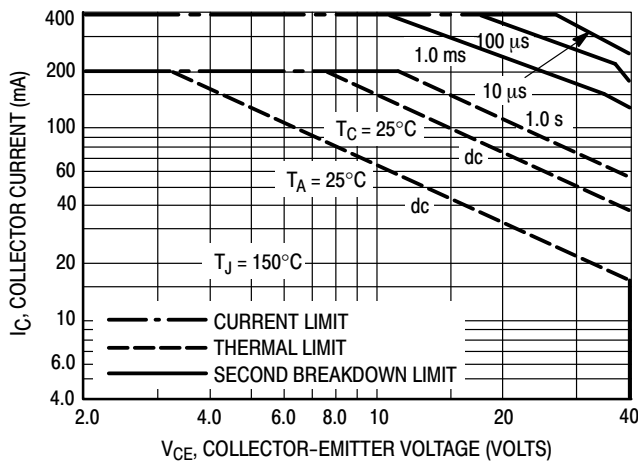

Figure 20.

The safe operating area curves indicate  $I_C$ - $V_{CE}$  limits of the transistor that must be observed for reliable operation. Collector load lines for specific circuits must fall below the limits indicated by the applicable curve.

The data of Figure 20 is based upon  $T_{J(pk)} = 150^\circ\text{C}$ ;  $T_C$  or  $T_A$  is variable depending upon conditions. Pulse curves are valid for duty cycles to 10% provided  $T_{J(pk)} \leq 150^\circ\text{C}$ .  $T_{J(pk)}$  may be calculated from the data in Figure 19. At high case or ambient temperatures, thermal limitations will reduce the power that can be handled to values less than the limitations imposed by second breakdown.

# BCW72LT1G, SBCW72LT1G

## PACKAGE DIMENSIONS

SOT-23 (TO-236)  
CASE 318-08  
ISSUE AR

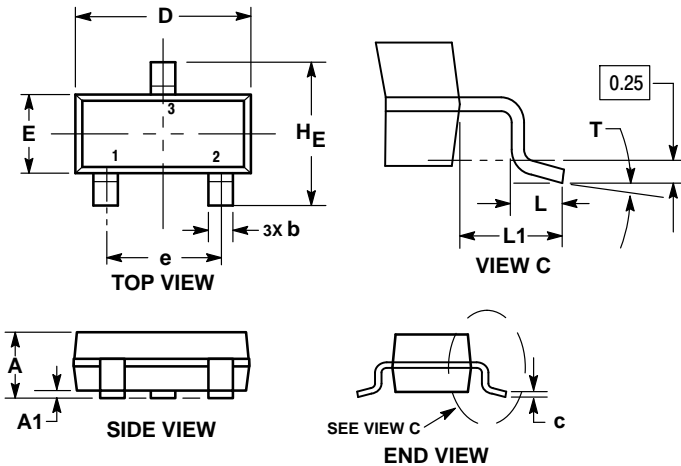

### NOTES:

1. DIMENSIONING AND TOLERANCING PER ASME Y14.5M, 1994.
2. CONTROLLING DIMENSION: MILLIMETERS.
3. MAXIMUM LEAD THICKNESS INCLUDES LEAD FINISH. MINIMUM LEAD THICKNESS IS THE MINIMUM THICKNESS OF THE BASE MATERIAL.
4. DIMENSIONS D AND E DO NOT INCLUDE MOLD FLASH, PROTRUSIONS, OR GATE BURRS.

DIM	MILLIMETERS			INCHES		
	MIN	NOM	MAX	MIN	NOM	MAX
A	0.89	1.00	1.11	0.035	0.039	0.044
A1	0.01	0.06	0.10	0.000	0.002	0.004
b	0.37	0.44	0.50	0.015	0.017	0.020
c	0.08	0.14	0.20	0.003	0.006	0.008
D	2.80	2.90	3.04	0.110	0.114	0.120
E	1.20	1.30	1.40	0.047	0.051	0.055
e	1.78	1.90	2.04	0.070	0.075	0.080
L	0.30	0.43	0.55	0.012	0.017	0.022
L1	0.35	0.54	0.69	0.014	0.021	0.027
HE	2.10	2.40	2.64	0.083	0.094	0.104
T	0°	---	10°	0°	---	10°

### STYLE 6:

- PIN 1. BASE
- EMITTER
- COLLECTOR

## RECOMMENDED SOLDERING FOOTPRINT\*

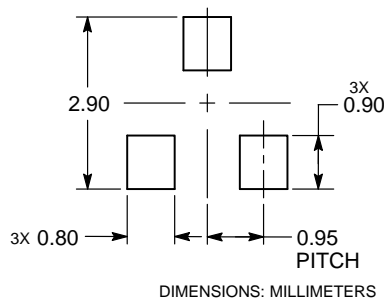

\*For additional information on our Pb-Free strategy and soldering details, please download the ON Semiconductor Soldering and Mounting Techniques Reference Manual, SOLDERRM/D.

ON Semiconductor and are trademarks of Semiconductor Components Industries, LLC dba ON Semiconductor or its subsidiaries in the United States and/or other countries. ON Semiconductor owns the rights to a number of patents, trademarks, copyrights, trade secrets, and other intellectual property. A listing of ON Semiconductor's product/patent coverage may be accessed at [www.onsemi.com/site/pdf/Patent-Marking.pdf](http://www.onsemi.com/site/pdf/Patent-Marking.pdf). ON Semiconductor reserves the right to make changes without further notice to any products herein. ON Semiconductor makes no warranty, representation or guarantee regarding the suitability of its products for any particular purpose, nor does ON Semiconductor assume any liability arising out of the application or use of any product or circuit, and specifically disclaims any and all liability, including without limitation special, consequential or incidental damages. Buyer is responsible for its products and applications using ON Semiconductor products, including compliance with all laws, regulations and safety requirements or standards, regardless of any support or applications information provided by ON Semiconductor. "Typical" parameters which may be provided in ON Semiconductor data sheets and/or specifications can and do vary in different applications and actual performance may vary over time. All operating parameters, including "Typicals" must be validated for each customer application by customer's technical experts. ON Semiconductor does not convey any license under its patent rights nor the rights of others. ON Semiconductor products are not designed, intended, or authorized for use as a critical component in life support systems or any FDA Class 3 medical devices or medical devices with a same or similar classification in a foreign jurisdiction or any devices intended for implantation in the human body. Should Buyer purchase or use ON Semiconductor products for any such unintended or unauthorized application, Buyer shall indemnify and hold ON Semiconductor and its officers, employees, subsidiaries, affiliates, and distributors harmless against all claims, costs, damages, and expenses, and reasonable attorney fees arising out of, directly or indirectly, any claim of personal injury or death associated with such unintended or unauthorized use, even if such claim alleges that ON Semiconductor was negligent regarding the design or manufacture of the part. ON Semiconductor is an Equal Opportunity/Affirmative Action Employer. This literature is subject to all applicable copyright laws and is not for resale in any manner.

## PUBLICATION ORDERING INFORMATION

### LITERATURE FULFILLMENT:

Literature Distribution Center for ON Semiconductor  
19521 E. 32nd Pkwy, Aurora, Colorado 80011 USA  
Phone: 303-675-2175 or 800-344-3860 Toll Free USA/Canada  
Fax: 303-675-2176 or 800-344-3867 Toll Free USA/Canada  
Email: [orderlit@onsemi.com](mailto:orderlit@onsemi.com)

**N. American Technical Support:** 800-282-9855 Toll Free  
USA/Canada  
**Europe, Middle East and Africa Technical Support:**  
Phone: 421 33 790 2910  
**Japan Customer Focus Center**  
Phone: 81-3-5817-1050

**ON Semiconductor Website:** [www.onsemi.com](http://www.onsemi.com)

**Order Literature:** <http://www.onsemi.com/orderlit>

For additional information, please contact your local Sales Representative

## Looking for pricing, stock, or lifecycle information?

Click below to explore more details on WIN SOURCE:

 [View BCW72LT1G on WIN SOURCE](#)

 [ON Semiconductor](#) Information

## Optimize Your Supply Chain with WIN SOURCE Solutions

-  Global Sourcing Solution
-  Obsolete Management
-  Cost Control Management
-  Shortage Management
-  Alternative Solution
-  Excess Inventory Management