



# THE DATASHEET OF ADUM5028-5BRIZ



## Low Emission, Isolated DC-to-DC Converters

**FEATURES**

- ▶ isoPower integrated, isolated dc-to-dc converter
- ▶ 100 mA output current for ADuM5020
- ▶ 60 mA output current for ADuM5028
- ▶ Meets CISPR22 Class B emissions limits at full load on a 2-layer PCB
- ▶ 16-lead SOIC\_W package with 7.8 mm minimum creepage
- ▶ 8-lead SOIC\_IC package with 8.3 mm minimum creepage
- ▶ High temperature operation: 125°C maximum
- ▶ Safety and regulatory approvals
  - ▶ UL recognition (pending): 3000 V rms for 1 minute per UL 1577
  - ▶ CSA certification per IEC 62368-1, IEC 61010-1, and IEC 60601-1
  - ▶ VDE certificate of conformity (pending)
    - ▶ VDE V 0884-10
    - ▶  $V_{IORM} = 565$  V peak
  - ▶ CQC certification per GB4943.1-2011 (pending)

**APPLICATIONS**

- ▶ RS-485/RS-422/CAN transceiver power
- ▶ Power supply start-up bias and gate drives
- ▶ Isolated sensor interfaces
- ▶ Industrial PLCs

**GENERAL DESCRIPTION**

The ADuM5020 and ADuM5028<sup>1</sup> are isoPower<sup>®</sup>, integrated, isolated dc-to-dc converters. Based on the Analog Devices, Inc., iCoupler<sup>®</sup> technology, these dc-to-dc converters provide regulated, isolated power that is below CISPR22 Class B limits at full load on a 2-layer printed circuit board (PCB) with ferrites. Common voltage combinations and the associated current output levels are shown in Table 1 through Table 6.

The ADuM5020 and ADuM5028 eliminate the need to design and build isolated dc-to-dc converters in applications up to 500 mW. The iCoupler chip scale transformer technology is used for the magnetic

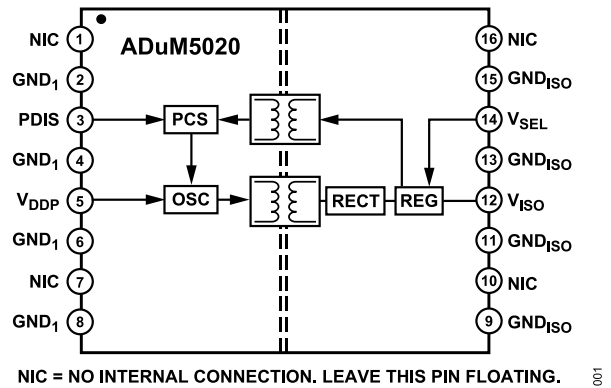
**FUNCTIONAL BLOCK DIAGRAMS**


Figure 1. ADuM5020 Functional Block Diagram

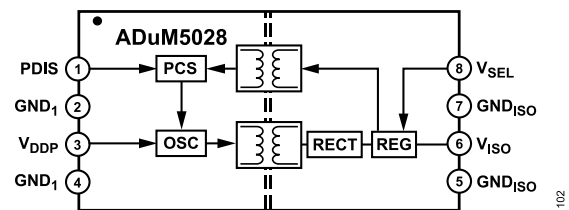


Figure 2. ADuM5028 Functional Block Diagram

components of the dc-to-dc converter. The result is a small form factor, isolated solution.

The ADuM5020 and ADuM5028 isolated dc-to-dc converters provide two different package variants: the ADuM5020 in a wide body, 16-lead SOIC\_W package, and the ADuM5028 in the space saving, 8-lead, wide body SOIC\_IC. For 5 V input operations, use the ADuM5020-5BRWZ and the ADuM5028-5BRIZ. For 3.3 V input to 3.3 V output ADuM5020, use the ADuM5020-3BRWZ and the ADuM5028-3RIZ. See the Pin Configuration and Function Descriptions section and the Ordering Guide for more information.

<sup>1</sup> Protected by U.S. Patents 5,952,849; 6,873,065; 6,903,578; and 7,075,329. Other patents are pending.

**TABLE OF CONTENTS**

Features.....	1	Recommended Operating Conditions.....	9
Applications.....	1	Absolute Maximum Ratings.....	11
Functional Block Diagrams.....	1	Maximum Continuous Working Voltage Supporting 50-Year Minimum Lifetime.....	11
General Description.....	1	ESD Caution.....	11
Specifications.....	3	Pin Configuration and Function Descriptions.....	12
Electrical Characteristics—5 V Primary Input Supply/5 V Secondary Isolated Supply.....	3	Typical Performance Characteristics.....	13
Electrical Characteristics—5 V Primary Input Supply/3.3 V Secondary Isolated Supply.....	4	Theory of Operation.....	16
Electrical Characteristics—3.3 V Primary Input Supply/3.3 V Secondary Isolated Supply.....	5	Applications Information.....	17
Regulatory Approvals.....	6	PCB Layout.....	17
Insulation and Safety Related Specifications.....	7	Thermal Analysis.....	18
Package Characteristics.....	7	EMI Considerations.....	18
DIN V VDE V 0884-10 (VDE V 0884-10) Insulation Characteristics.....	8	Insulation Lifetime.....	18
		Outline Dimensions.....	20
		Ordering Guide.....	20
		Evaluation Boards.....	21

**REVISION HISTORY****11/2023—Rev. A to Rev. B**

Changes to Features Section.....	1
Changes to Table 7.....	6
Added Table 8; Renumbered Sequentially.....	6

## SPECIFICATIONS

## ELECTRICAL CHARACTERISTICS—5 V PRIMARY INPUT SUPPLY/5 V SECONDARY ISOLATED SUPPLY

All typical specifications are at  $T_A = 25^\circ\text{C}$ ,  $V_{DDP} = V_{ISO} = 5\text{ V}$ . Minimum and maximum specifications apply over the entire recommended operation range, which is  $4.5\text{ V} \leq V_{DDP} \leq 5.5\text{ V}$ ,  $4.5\text{ V} \leq V_{ISO} \leq 5.5\text{ V}$ , and  $-40^\circ\text{C} \leq T_A \leq +125^\circ\text{C}$ , unless otherwise noted.

Table 1. ADuM5020-5BRIZ DC-to-DC Converter Static Specifications

Parameter	Symbol	Min	Typ	Max	Unit	Test Conditions/Comments
DC-TO-DC CONVERTER SUPPLY						
Setpoint	$V_{ISO}$	4.75	5.0	5.25	V	$V_{ISO}$ output current ( $I_{ISO}$ ) = 10 mA
Line Regulation	$V_{ISO}$ (LINE)		2		mV/V	$I_{ISO} = 50\text{ mA}$ , $V_{DDP} = 4.5\text{ V}$ to $5.5\text{ V}$
Load Regulation <sup>1</sup>	$V_{ISO}$ (LOAD)		1	5	%	$I_{ISO} = 10\text{ mA}$ to $90\text{ mA}$
Output Ripple <sup>1</sup>	$V_{ISO}$ (RIP)		75		mV p-p	20 MHz bandwidth, bypass output capacitance ( $C_{BO}$ ) = $0.1\ \mu\text{F}  10\ \mu\text{F}$ , $I_{ISO} = 90\text{ mA}$
Output Noise <sup>1</sup>	$V_{ISO}$ (NOISE)		200		mV p-p	$C_{BO} = 0.1\ \mu\text{F}  10\ \mu\text{F}$ , $I_{ISO} = 90\text{ mA}$
Switching Frequency	$f_{OSC}$		180		MHz	
Pulse-Width Modulation (PWM) Frequency	$f_{PWM}$		625		kHz	
Output Supply Current <sup>1</sup>	$I_{ISO}$ (MAX)	50			mA	$4.75\text{ V} < V_{ISO} < 5.25\text{ V}$
		100			mA	$4.5\text{ V} < V_{ISO} < 5.25\text{ V}$
Efficiency at $I_{ISO}$ (MAX)			33		%	$I_{ISO} = 100\text{ mA}$ , $T_A = 25^\circ\text{C}$
$V_{DDP}$ Supply Current						
No $V_{ISO}$ Load	$I_{DDP}$ (Q)		8	25	mA	
Full $V_{ISO}$ Load	$I_{DDP}$ (MAX)		310		mA	
Thermal Shutdown						
Shutdown Temperature			154		$^\circ\text{C}$	
Thermal Hysteresis			10		$^\circ\text{C}$	

<sup>1</sup> Maximum  $V_{ISO}$  output current is derated by  $1.75\text{ mA}/^\circ\text{C}$  for  $T_A > 85^\circ\text{C}$ .

Table 2. ADuM5028-5BRIZ DC-to-DC Converter Static Specifications

Parameter	Symbol	Min	Typ	Max	Unit	Test Conditions/Comments
DC-TO-DC CONVERTER SUPPLY						
Setpoint	$V_{ISO}$	4.75	5.0	5.25	V	$I_{ISO} = 10\text{ mA}$
Line Regulation	$V_{ISO}$ (LINE)		2		mV/V	$I_{ISO} = 30\text{ mA}$ , $V_{DDP} = 4.5\text{ V}$ to $5.5\text{ V}$
Load Regulation <sup>1</sup>	$V_{ISO}$ (LOAD)		1	5	%	$I_{ISO} = 6\text{ mA}$ to $54\text{ mA}$
Output Ripple <sup>1</sup>	$V_{ISO}$ (RIP)		75		mV p-p	20 MHz bandwidth, $C_{BO} = 0.1\ \mu\text{F}  10\ \mu\text{F}$ , $I_{ISO} = 54\text{ mA}$
Output Noise <sup>1</sup>	$V_{ISO}$ (NOISE)		200		mV p-p	$C_{BO} = 0.1\ \mu\text{F}  10\ \mu\text{F}$ , $I_{ISO} = 54\text{ mA}$
Switching Frequency	$f_{OSC}$		180		MHz	
PWM Frequency	$f_{PWM}$		625		kHz	
Output Supply Current <sup>1</sup>	$I_{ISO}$ (MAX)	60			mA	$4.75\text{ V} < V_{ISO} < 5.25\text{ V}$
Efficiency at $I_{ISO}$ (MAX)			33		%	$I_{ISO} = 60\text{ mA}$ , $T_A = 25^\circ\text{C}$
$V_{DDP}$ Supply Current						
No $V_{ISO}$ Load	$I_{DDP}$ (Q)		8	25	mA	
Full $V_{ISO}$ Load	$I_{DDP}$ (MAX)		190		mA	
Thermal Shutdown						
Shutdown Temperature			154		$^\circ\text{C}$	
Thermal Hysteresis			10		$^\circ\text{C}$	

<sup>1</sup> Maximum  $V_{ISO}$  output current is derated by  $1\text{ mA}/^\circ\text{C}$  for  $T_A > 85^\circ\text{C}$ .

## SPECIFICATIONS

## ELECTRICAL CHARACTERISTICS—5 V PRIMARY INPUT SUPPLY/3.3 V SECONDARY ISOLATED SUPPLY

All typical specifications are at  $T_A = 25^\circ\text{C}$ ,  $V_{DDP} = 5.0\text{ V}$ ,  $V_{ISO} = 3.3\text{ V}$ . Minimum/maximum specifications apply over the entire recommended operation range, which is  $4.5\text{ V} \leq V_{DDP} \leq 5.5\text{ V}$ ,  $3.0\text{ V} \leq V_{ISO} \leq 3.6\text{ V}$ , and  $-40^\circ\text{C} \leq T_A \leq +125^\circ\text{C}$ , unless otherwise noted.

Table 3. ADuM5020-5BRIZ DC-to-DC Converter Static Specifications

Parameter	Symbol	Min	Typ	Max	Unit	Test Conditions/Comments
DC-TO-DC CONVERTER SUPPLY						
Setpoint	$V_{ISO}$	3.135	3.3	3.465	V	$I_{ISO} = 10\text{ mA}$
Line Regulation	$V_{ISO}(\text{LINE})$		2		mV/V	$I_{ISO} = 50\text{ mA}$ , $V_{DDP} = 4.5\text{ V to }5.5\text{ V}$
Load Regulation <sup>1</sup>	$V_{ISO}(\text{LOAD})$		1	5	%	$I_{ISO} = 10\text{ mA to }90\text{ mA}$
Output Ripple <sup>1</sup>	$V_{ISO}(\text{RIP})$		50		mV p-p	20 MHz bandwidth, $C_{BO} = 0.1\ \mu\text{F}  10\ \mu\text{F}$ , $I_{ISO} = 90\text{ mA}$
Output Noise <sup>1</sup>	$V_{ISO}(\text{NOISE})$		130		mV p-p	$C_{BO} = 0.1\ \mu\text{F}  10\ \mu\text{F}$ , $I_{ISO} = 90\text{ mA}$
Switching Frequency	$f_{OSC}$		180		MHz	
PWM Frequency	$f_{PWM}$		625		kHz	
Output Supply Current <sup>1</sup>	$I_{ISO}(\text{MAX})$	50			mA	$3.135\text{ V} < V_{ISO} < 3.465\text{ V}$
		100			mA	$3.0\text{ V} < V_{ISO} < 3.465\text{ V}$
Efficiency at $I_{ISO}(\text{MAX})$			27		%	$I_{ISO} = 100\text{ mA}$ , $T_A = 25^\circ\text{C}$
V <sub>DDP</sub> Supply Current						
No $V_{ISO}$ Load	$I_{DDP}(\text{Q})$		5	18	mA	
Full $V_{ISO}$ Load	$I_{DDP}(\text{MAX})$		250		mA	
Thermal Shutdown						
Shutdown Temperature			154		$^\circ\text{C}$	
Thermal Hysteresis			10		$^\circ\text{C}$	

<sup>1</sup> Maximum  $V_{ISO}$  output current is derated by  $1.75\text{ mA}/^\circ\text{C}$  for  $T_A > 85^\circ\text{C}$ .

Table 4. ADuM5028-5BRIZ DC-to-DC Converter Static Specifications

Parameter	Symbol	Min	Typ	Max	Unit	Test Conditions/Comments
DC-TO-DC CONVERTER SUPPLY						
Setpoint	$V_{ISO}$	3.135	3.3	3.465	V	$I_{ISO} = 10\text{ mA}$
Line Regulation	$V_{ISO}(\text{LINE})$		2		mV/V	$I_{ISO} = 30\text{ mA}$ , $V_{DDP} = 4.5\text{ V to }5.5\text{ V}$
Load Regulation <sup>1</sup>	$V_{ISO}(\text{LOAD})$		1	5	%	$I_{ISO} = 6\text{ mA to }54\text{ mA}$
Output Ripple <sup>1</sup>	$V_{ISO}(\text{RIP})$		50		mV p-p	20 MHz bandwidth, $C_{BO} = 0.1\ \mu\text{F}  10\ \mu\text{F}$ , $I_{ISO} = 54\text{ mA}$
Output Noise <sup>1</sup>	$V_{ISO}(\text{NOISE})$		130		mV p-p	$C_{BO} = 0.1\ \mu\text{F}  10\ \mu\text{F}$ , $I_{ISO} = 54\text{ mA}$
Switching Frequency	$f_{OSC}$		180		MHz	
PWM Frequency	$f_{PWM}$		625		kHz	
Output Supply Current <sup>1</sup>	$I_{ISO}(\text{MAX})$	30			mA	$3.135\text{ V} < V_{ISO} < 3.465\text{ V}$
		60			mA	$3.0\text{ V} < V_{ISO} < 3.465\text{ V}$
Efficiency at $I_{ISO}(\text{MAX})$			27		%	$I_{ISO} = 60\text{ mA}$ , $T_A = 25^\circ\text{C}$
V <sub>DDP</sub> Supply Current						
No $V_{ISO}$ Load	$I_{DDP}(\text{Q})$		5	18	mA	
Full $V_{ISO}$ Load	$I_{DDP}(\text{MAX})$		150		mA	
Thermal Shutdown						
Shutdown Temperature			154		$^\circ\text{C}$	
Thermal Hysteresis			10		$^\circ\text{C}$	

<sup>1</sup> Maximum  $V_{ISO}$  output current is derated by  $1\text{ mA}/^\circ\text{C}$  for  $T_A > 85^\circ\text{C}$ .

## SPECIFICATIONS

## ELECTRICAL CHARACTERISTICS—3.3 V PRIMARY INPUT SUPPLY/3.3 V SECONDARY ISOLATED SUPPLY

All typical specifications are at  $T_A = 25^\circ\text{C}$ ,  $V_{DDP} = 3.3\text{ V}$ ,  $V_{ISO} = 3.3\text{ V}$ . Minimum/maximum specifications apply over the entire recommended operation range, which is  $3.0\text{ V} \leq V_{DDP} \leq 3.6\text{ V}$ ,  $3.0\text{ V} \leq V_{ISO} \leq 3.6\text{ V}$ , and  $-40^\circ\text{C} \leq T_A \leq +125^\circ\text{C}$ , unless otherwise noted.

Table 5. ADuM5020-3BRWZ DC-to-DC Converter Static Specifications

Parameter	Symbol	Min	Typ	Max	Unit	Test Conditions/Comments
DC-TO-DC CONVERTER SUPPLY						
Setpoint	$V_{ISO}$	3.135	3.3	3.465	V	$I_{ISO} = 10\text{ mA}$
Line Regulation	$V_{ISO}(\text{LINE})$		2		mV/V	$I_{ISO} = 50\text{ mA}$ , $V_{DDP} = 3.0\text{ V to }3.6\text{ V}$
Load Regulation <sup>1</sup>	$V_{ISO}(\text{LOAD})$		1	5	%	$I_{ISO} = 7\text{ mA to }63\text{ mA}$
Output Ripple <sup>1</sup>	$V_{ISO}(\text{RIP})$		50		mV p-p	20 MHz bandwidth, $C_{BO} = 0.1\ \mu\text{F}  10\ \mu\text{F}$ , $I_{ISO} = 90\text{ mA}$
Output Noise <sup>1</sup>	$V_{ISO}(\text{NOISE})$		130		mV p-p	$C_{BO} = 0.1\ \mu\text{F}  10\ \mu\text{F}$ , $I_{ISO} = 90\text{ mA}$
Switching Frequency	$f_{OSC}$		180		MHz	
PWM Frequency	$f_{PWM}$		625		kHz	
Output Supply Current <sup>1</sup>	$I_{ISO}(\text{MAX})$	35			mA	$3.135\text{ V} < V_{ISO} < 3.465\text{ V}$
		70			mA	$3.0\text{ V} < V_{ISO} < 3.465\text{ V}$
Efficiency at $I_{ISO}(\text{MAX})$			33		%	$I_{ISO} = 70\text{ mA}$ , $T_A = 25^\circ\text{C}$
V <sub>DDP</sub> Supply Current						
No $V_{ISO}$ Load	$I_{DDP}(\text{Q})$		5	15	mA	
Full $V_{ISO}$ Load	$I_{DDP}(\text{MAX})$		225		mA	
Thermal Shutdown						
Shutdown Temperature			154		$^\circ\text{C}$	
Thermal Hysteresis			10		$^\circ\text{C}$	

<sup>1</sup> Maximum  $V_{ISO}$  output current is derated by  $2\text{ mA}/^\circ\text{C}$  for  $T_A > 105^\circ\text{C}$ .

Table 6. ADuM5028-3BRIZ DC-to-DC Converter Static Specifications

Parameter	Symbol	Min	Typ	Max	Unit	Test Conditions/Comments
DC-TO-DC CONVERTER SUPPLY						
Setpoint	$V_{ISO}$	3.135	3.3	3.465	V	$I_{ISO} = 10\text{ mA}$
Line Regulation	$V_{ISO}(\text{LINE})$		2		mV/V	$I_{ISO} = 30\text{ mA}$ , $V_{DDP} = 3.0\text{ V to }3.6\text{ V}$
Load Regulation <sup>1</sup>	$V_{ISO}(\text{LOAD})$		1	5	%	$I_{ISO} = 6\text{ mA to }54\text{ mA}$
Output Ripple <sup>1</sup>	$V_{ISO}(\text{RIP})$		50		mV p-p	20 MHz bandwidth, $C_{BO} = 0.1\ \mu\text{F}  10\ \mu\text{F}$ , $I_{ISO} = 54\text{ mA}$
Output Noise <sup>1</sup>	$V_{ISO}(\text{NOISE})$		130		mV p-p	$C_{BO} = 0.1\ \mu\text{F}  10\ \mu\text{F}$ , $I_{ISO} = 54\text{ mA}$
Switching Frequency	$f_{OSC}$		180		MHz	
PWM Frequency	$f_{PWM}$		625		kHz	
Output Supply Current <sup>1</sup>	$I_{ISO}(\text{MAX})$	30			mA	$3.135\text{ V} < V_{ISO} < 3.465\text{ V}$
		60			mA	$3.0\text{ V} < V_{ISO} < 3.465\text{ V}$
Efficiency at $I_{ISO}(\text{MAX})$			33		%	$I_{ISO} = 60\text{ mA}$ , $T_A = 25^\circ\text{C}$
V <sub>DDP</sub> Supply Current						
No $V_{ISO}$ Load	$I_{DDP}(\text{Q})$		5	15	mA	
Full $V_{ISO}$ Load	$I_{DDP}(\text{MAX})$		190		mA	
Thermal Shutdown						
Shutdown Temperature			154		$^\circ\text{C}$	
Thermal Hysteresis			10		$^\circ\text{C}$	

<sup>1</sup> Maximum  $V_{ISO}$  output current is derated by  $2\text{ mA}/^\circ\text{C}$  for  $T_A > 105^\circ\text{C}$ .

## SPECIFICATIONS

## REGULATORY APPROVALS

Table 7. RW-16 Wide-Body [SOIC\_W] Package

Regulatory Agency	Standard Certification/Approval	File
UL (Pending) <sup>1</sup>	Recognized under 1577 component recognition program <sup>1</sup> Single protection, 3000 V rms isolation voltage	File E214100
CSA	Approved under CSA component acceptance CSA 62368-1:19, UPD1:2021, IEC 62368-1:2018 Edition 3, and EN 62368-1:2020+A11:2020: Basic insulation at 600 V rms mains, 780 V rms (1103 V peak) Reinforced insulation at 300 V rms mains, 390 V rms (552 V peak) CSA 61010-1-12+A1 and IEC 61010-1 Edition 3+A1: Basic insulation at 600 V rms Reinforced insulation at 300 V rms CSA 60601-1:14 (R2018) and IEC 60601-1 Edition 3+A1+A2: Basic insulation (1 means of patient protection (1 MOPP)), 419 V rms (593 V peak) Reinforced insulation (2 means of patient protection (2 MOPP)), 50 V rms (71 V peak)	File 205078
TÜV SÜD	Certified as component level device EN IEC 62368-1:2020/A11:2022	File B0562320022
VDE (Pending) <sup>2</sup>	DIN V VDE V 0884-10 (VDE V 0884-10):2006-12 Reinforced insulation 565 V peak, surge isolation voltage ( $V_{IOSM}$ ) = 6000 V peak Transient voltage ( $V_{IOTM}$ ) = 4242 V peak	File 2471900-4880-0001
CQC (Pending)	Certified under CQC11-471543-2012 GB4943.1-2011: basic insulation at 780 V rms (1103 V peak) Reinforced insulation at 390 V rms (552 V peak)	File (pending)

<sup>1</sup> In accordance with UL 1577, each ADuM5020 and ADuM5028 are proof tested by applying an insulation test voltage  $\geq 3600$  V rms for 1 sec.

<sup>2</sup> In accordance with DIN V VDE V 0884-10, each ADuM5020 and ADuM5028 are proof tested by applying an insulation test voltage  $\geq 1059$  V peak for 1 sec (partial discharge detection limit = 5 pC). The \* marking branded on the component designates DIN V VDE V 0884-10 approval.

Table 8. RI-8 Wide-Body with Increased Creepage [SOIC\_IC] Package

Regulatory Agency	Standard Certification/Approval	File
UL (Pending) <sup>1</sup>	Recognized under 1577 component recognition program <sup>1</sup> Single protection, 3000 V rms isolation voltage	File E214100
CSA	Approved under CSA component acceptance CSA 62368-1:19, UPD1:2021, IEC 62368-1:2018 Edition 3, and EN 62368-1:2020+A11:2020: Basic insulation at 600 V rms mains, 830 V rms (1173 V peak) Reinforced insulation at 300 V rms mains, 415 V rms (586 V peak) CSA 61010-1-12+A1 and IEC 61010-1 Edition 3+A1: Basic insulation at 600 V rms (848 V peak) Reinforced insulation at 300 V rms (424 V peak) CSA 60601-1:14 (R2018) and IEC 60601-1 Edition 3+A1+A2: Basic insulation (1 means of patient protection (1 MOPP)), 419 V rms (593 V peak) Reinforced insulation (2 means of patient protection (2 MOPP)), 50 V rms (71 V peak)	File 205078
TÜV SÜD	Certified as component level device EN IEC 62368-1:2020/A11:2022	File B0562320022
VDE (Pending) <sup>2</sup>	DIN V VDE V 0884-10 (VDE V 0884-10):2006-12 Reinforced insulation 565 V peak, surge isolation voltage ( $V_{IOSM}$ ) = 6000 V peak Transient voltage ( $V_{IOTM}$ ) = 4242 V peak	File 2471900-4880-0001

## SPECIFICATIONS

Table 8. RI-8 Wide-Body with Increased Creepage [SOIC\_IC] Package (Continued)

Regulatory Agency	Standard Certification/Approval	File
CQC (Pending)	Certified under CQC11-471543-2012 GB4943.1-2011: basic insulation at 780 V rms (1103 V peak) Reinforced insulation at 390 V rms (552 V peak)	File (pending)

<sup>1</sup> In accordance with UL 1577, each ADuM5020 and ADuM5028 are proof tested by applying an insulation test voltage  $\geq 3600$  V rms for 1 sec.

<sup>2</sup> In accordance with DIN V VDE V 0884-10, each ADuM5020 and ADuM5028 are proof tested by applying an insulation test voltage  $\geq 1059$  V peak for 1 sec (partial discharge detection limit = 5 pC). The \* marking branded on the component designates DIN V VDE V 0884-10 approval.

## INSULATION AND SAFETY RELATED SPECIFICATIONS

For additional information, see [www.analog.com/icouplersafety](http://www.analog.com/icouplersafety).

Table 9. ADuM5020 Insulation and Safety

Parameter	Symbol	Value	Unit	Test Conditions/Comments
Rated Dielectric Insulation Voltage		3000	V rms	1-minute duration
Minimum External Air Gap (Clearance)	L (I01)	7.8	mm min	Measured from input terminals to output terminals, shortest distance through air
Minimum External Tracking (Creepage)	L (I02)	7.8	mm min	Measured from input terminals to output terminals, shortest distance path along body
Minimum Clearance in the Plane of the Printed Circuit Board (PCB Clearance)	L (PCB)	8.3	mm min	Measured from input terminals to output terminals, shortest distance through air, line of sight, in the PCB mounting plane
Minimum Internal Gap (Internal Clearance)		25.5	$\mu\text{m}$ min	Insulation distance through insulation
Tracking Resistance (Comparative Tracking Index)	CTI	>600	V	DIN IEC 112/VDE 0303 Part 1
Material Group		I		Material Group (DIN VDE 0110, 1/89, Table 1)

Table 10. ADuM5028 Insulation and Safety

Parameter	Symbol	Value	Unit	Test Conditions/Comments
Rated Dielectric Insulation Voltage		3000	V rms	1-minute duration
Minimum External Air Gap (Clearance)	L (I01)	8.3	mm min	Measured from input terminals to output terminals, shortest distance through air
Minimum External Tracking (Creepage)	L (I02)	8.3	mm min	Measured from input terminals to output terminals, shortest distance path along body
Minimum Clearance in the Plane of the Printed Circuit Board (PCB Clearance)	L (PCB)	8.3	mm min	Measured from input terminals to output terminals, shortest distance through air, line of sight, in the PCB mounting plane
Minimum Internal Gap (Internal Clearance)		25.5	$\mu\text{m}$ min	Insulation distance through insulation
Tracking Resistance (Comparative Tracking Index)	CTI	>600	V	DIN IEC 112/VDE 0303 Part 1
Material Group		I		Material Group (DIN VDE 0110, 1/89, Table 1)

## PACKAGE CHARACTERISTICS

Table 11. ADuM5020 Package Characteristics

Parameter	Symbol	Min	Typ	Max	Unit	Test Conditions/Comments
Resistance (Input to Output) <sup>1</sup>	$R_{I-O}$		$10^{13}$		$\Omega$	
Capacitance (Input to Output) <sup>1</sup>	$C_{I-O}$		2.2		pF	f = 1 MHz
Input Capacitance <sup>2</sup>	$C_I$		4.0		pF	
IC Junction to Ambient Thermal Resistance	$\theta_{JA}$		45		$^{\circ}\text{C}/\text{W}$	Thermocouple located at center of package underside <sup>3</sup>

<sup>1</sup> This device is considered a 2-terminal device: Pin 1 through Pin 8 are shorted together, and Pin 9 through Pin 16 are shorted together.

<sup>2</sup> Input capacitance is from any input data pin to ground.

<sup>3</sup> The value of  $\theta_{JA}$  is based on devices mounted on a JEDEC JESD-51 standard 2s2p board and still air.

## SPECIFICATIONS

Table 12. ADuM5028 Package Characteristics

Parameter	Symbol	Min	Typ	Max	Unit	Test Conditions/Comments
Resistance (Input to Output) <sup>1</sup>	R <sub>I-O</sub>		10 <sup>13</sup>		Ω	
Capacitance (Input to Output) <sup>1</sup>	C <sub>I-O</sub>		2.2		pF	f = 1 MHz
Input Capacitance <sup>2</sup>	C <sub>I</sub>		4.0		pF	
IC Junction to Ambient Thermal Resistance	θ <sub>JA</sub>		80		°C/W	Thermocouple located at center of package underside <sup>3</sup>

<sup>1</sup> This device is considered a 2-terminal device: Pin 1 through Pin 4 are shorted together, and Pin 5 through Pin 8 are shorted together.

<sup>2</sup> Input capacitance is from any input data pin to ground.

<sup>3</sup> The value of θ<sub>JA</sub> is based on devices mounted on a JEDEC JESD-51 standard 2s2p board and still air.

## DIN V VDE V 0884-10 (VDE V 0884-10) INSULATION CHARACTERISTICS

These isolators are suitable for reinforced electrical isolation only within the safety limit data. Maintenance of the safety data is ensured by the protective circuits. The asterisk (\*) marking on packages denotes DIN V VDE V 0884-10 approval.

Table 13. ADuM5020 VDE Characteristics

Description	Test Conditions/Comments	Symbol	Characteristic	Unit
Installation Classification per DIN VDE 0110				
For Rated Mains Voltage ≤ 150 V rms			I to IV	
For Rated Mains Voltage ≤ 300 V rms			I to III	
For Rated Mains Voltage ≤ 400 V rms			I to II	
Climatic Classification			40/125/21	
Pollution Degree per DIN VDE 0110, Table 1			2	
Maximum Working Insulation Voltage		V <sub>IORM</sub>	565	V peak
Input to Output Test Voltage, Method b1	V <sub>IORM</sub> × 1.875 = V <sub>PR</sub> , 100% production test, t <sub>m</sub> = 1 sec, partial discharge < 5 pC	V <sub>PR</sub>	1059	V peak
Input to Output Test Voltage, Method a		V <sub>PR</sub>		
After Environmental Tests Subgroup 1	V <sub>IORM</sub> × 1.5 = V <sub>pd(m)</sub> , t <sub>ni</sub> = 60 sec, t <sub>m</sub> = 10 sec, partial discharge < 5 pC	V <sub>pd(m)</sub>	848	V peak
After Input or Safety Test Subgroup 2 and Subgroup 3	V <sub>IORM</sub> × 1.2 = V <sub>pd(m)</sub> , t <sub>ni</sub> = 60 sec, t <sub>m</sub> = 10 sec, partial discharge < 5 pC	V <sub>pd(m)</sub>	678	V peak
Highest Allowable Overvoltage	Transient overvoltage, t <sub>TR</sub> = 10 sec	V <sub>IO<sub>TM</sub></sub>	4242	V peak
Withstand Isolation Voltage	1 minute withstand rating	V <sub>ISO</sub>	3000	V rms
Surge Isolation Voltage Reinforced	V <sub>IOSM(TE<sub>ST</sub>)</sub> = 10 kV; 1.2 μs rise time; 50 μs, 50% fall time	V <sub>IOSM</sub>	6000	V peak
Safety Limiting Values	Maximum value allowed in the event of a failure (see Figure 3)			
Case Temperature		T <sub>S</sub>	150	°C
Total Power Dissipation at 25°C		I <sub>S1</sub>	2.78	W
Insulation Resistance at T <sub>S</sub>	V <sub>IO</sub> = 500 V	R <sub>S</sub>	>10 <sup>9</sup>	Ω

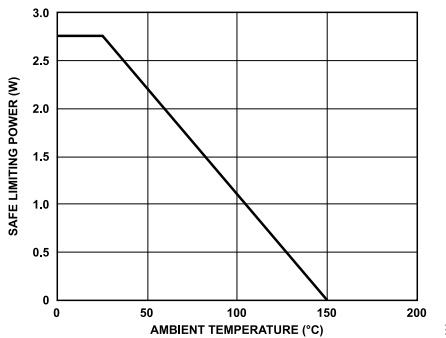
Table 14. ADuM5028 VDE Characteristics

Description	Test Conditions/Comments	Symbol	Characteristic	Unit
Installation Classification per DIN VDE 0110				
For Rated Mains Voltage ≤ 150 V rms			I to IV	
For Rated Mains Voltage ≤ 300 V rms			I to III	
For Rated Mains Voltage ≤ 400 V rms			I to II	
Climatic Classification			40/125/21	
Pollution Degree per DIN VDE 0110, Table 1			2	
Maximum Working Insulation Voltage		V <sub>IORM</sub>	565	V peak
Input to Output Test Voltage, Method b1	V <sub>IORM</sub> × 1.875 = V <sub>PR</sub> , 100% production test, t <sub>m</sub> = 1 sec, partial discharge < 5 pC	V <sub>PR</sub>	1059	V peak

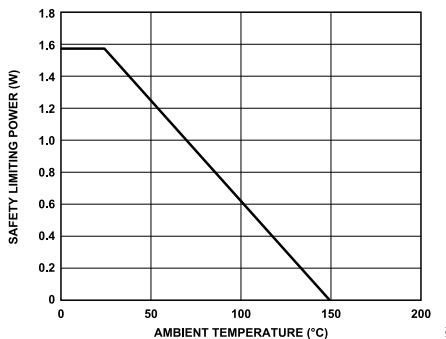
**SPECIFICATIONS**

**Table 14. ADuM5028 VDE Characteristics (Continued)**

Description	Test Conditions/Comments	Symbol	Characteristic	Unit
Input to Output Test Voltage, Method a After Environmental Tests Subgroup 1	$V_{IORM} \times 1.5 = V_{pd(m)}$ , $t_{ini} = 60$ sec, $t_m = 10$ sec, partial discharge < 5 pC	$V_{PR}$ $V_{pd(m)}$	848	V peak
After Input and/or Safety Test Subgroup 2 and Subgroup 3	$V_{IORM} \times 1.2 = V_{pd(m)}$ , $t_{ini} = 60$ sec, $t_m = 10$ sec, partial discharge < 5 pC	$V_{pd(m)}$	678	V peak
Highest Allowable Overvoltage	Transient overvoltage, $t_{TR} = 10$ sec	$V_{IOTM}$	4242	V peak
Withstand Isolation Voltage	1 minute withstand rating	$V_{ISO}$	3000	V rms
Surge Isolation Voltage Reinforced	$V_{IOSM(TESt)} = 10$ kV; 1.2 $\mu$ s rise time; 50 $\mu$ s, 50% fall time	$V_{IOSM}$	6000	V peak
Safety Limiting Values	Maximum value allowed in the event of a failure (see Figure 4)			
Case Temperature		$T_S$	150	°C
Total Power Dissipation at 25°C		$I_{S1}$	1.56	W
Insulation Resistance at $T_S$	$V_{IO} = 500$ V	$R_S$	>10 <sup>9</sup>	$\Omega$



**Figure 3. ADuM5020 Thermal Derating Curve, Dependence of Safety Limiting Values with Ambient Temperature per DIN V VDE V 0884-10**



**Figure 4. ADuM5028 Thermal Derating Curve, Dependence of Safety Limiting Values with Ambient Temperature per DIN V VDE V 0884-10**

**RECOMMENDED OPERATING CONDITIONS**

**Table 15.**

Parameter	Symbol	Min	Typ	Max	Unit
Operating Temperature <sup>1</sup>	$T_A$	-40		+125	°C
Supply Voltages <sup>2</sup>	$V_{DDP}$				
ADuM5020-5BRWZ, ADuM5028-5BRIZ, $V_{DDP}$ at $V_{ISO} = 3.135$ V to 3.465 V		4.5		5.5	V
ADuM5020-3BRWZ, ADuM5028-3BRIZ, $V_{DDP}$ at $V_{ISO} = 3.135$ V to 3.465 V		3.0		3.6	V

## SPECIFICATIONS

Table 15. (Continued)

Parameter	Symbol	Min	Typ	Max	Unit
ADuM5020-5BRWZ, ADuM5028-5BRIZ, $V_{DDP}$ at $V_{ISO} = 4.75$ V to 5.25 V		4.5		5.5	V

<sup>1</sup> Operation at >85°C requires reduction of the maximum load current.

<sup>2</sup> Each voltage is relative to its respective ground.

**ABSOLUTE MAXIMUM RATINGS**

$T_A = 25^\circ\text{C}$ , unless otherwise noted.

**Table 16.**

Parameter	Rating
Storage Temperature ( $T_{ST}$ )	$-55^\circ\text{C}$ to $+150^\circ\text{C}$
Ambient Operating Temperature ( $T_A$ )	$-40^\circ\text{C}$ to $+125^\circ\text{C}$
Supply Voltages ( $V_{DDP}$ , $V_{ISO}$ ) <sup>1</sup>	$-0.5\text{ V}$ to $+7.0\text{ V}$
$V_{ISO}$ Supply Current	
ADuM5020	100 mA
ADuM5028	60 mA
Input Voltage (PDIS, $V_{SEL}$ ) <sup>1,2</sup>	$-0.5\text{ V}$ to $V_{DDI} + 0.5\text{ V}$
Common-Mode Transients <sup>3</sup>	$-200\text{ kV}/\mu\text{s}$ to $+200\text{ kV}/\mu\text{s}$

<sup>1</sup> All voltages are relative to their respective ground.

<sup>2</sup>  $V_{DDI}$  is the input side supply voltage.

<sup>3</sup> Common-mode transients refer to common-mode transients across the insulation barrier. Common-mode transients exceeding the absolute maximum ratings may cause latch-up or permanent damage.

Stresses at or above those listed under Absolute Maximum Ratings may cause permanent damage to the product. This is a stress rating only; functional operation of the product at these or any other conditions above those indicated in the operational section of this specification is not implied. Operation beyond the maximum operating conditions for extended periods may affect product reliability.

**MAXIMUM CONTINUOUS WORKING VOLTAGE SUPPORTING 50-YEAR MINIMUM LIFETIME****Table 17.**

Parameter <sup>1</sup>	Max	Unit	Applicable Certification
AC Voltage			
Bipolar Waveform	560	V peak	50-year operation
Unipolar Waveform			
Basic Insulation	560	V peak	50-year operation
DC Voltage			
Basic Insulation	1000	V peak	50-year operation

<sup>1</sup> Maximum continuous working voltage refers to the continuous voltage magnitude imposed across the isolation barrier. See the [Insulation Lifetime](#) section for more information.

**ESD CAUTION**

**ESD (electrostatic discharge) sensitive device.** Charged devices and circuit boards can discharge without detection. Although this product features patented or proprietary protection circuitry, damage may occur on devices subjected to high energy ESD. Therefore, proper ESD precautions should be taken to avoid performance degradation or loss of functionality.

**PIN CONFIGURATION AND FUNCTION DESCRIPTIONS**

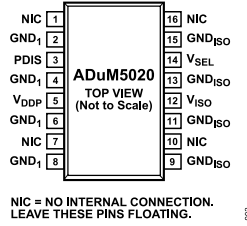


Figure 5. ADuM5020 Pin Configuration

Table 18. ADuM5020 Pin Function Descriptions

Pin No.	Mnemonic	Description
1, 7, 10, 16	NIC	No Internal Connection. Leave these pins floating.
2, 4, 6, 8	GND <sub>1</sub>	Ground 1. Ground reference for the primary. It is recommended that these pins be connected to a common ground.
3	PDIS	Power Disable. When tied to any GND <sub>1</sub> pin, the V <sub>ISO</sub> output voltage is active. When a logic high voltage is applied, the V <sub>ISO</sub> output voltage is shut down. Do not leave this pin floating.
5	V <sub>DDP</sub>	Primary Supply Voltage.
9, 11, 13, 15	GND <sub>ISO</sub>	Ground Reference for V <sub>ISO</sub> on Side 2. It is recommended that these pins be connected to a common ground.
12	V <sub>ISO</sub>	Secondary Supply Voltage Output for External Loads.
14	V <sub>SEL</sub>	Output Voltage Selection. Connect V <sub>SEL</sub> to V <sub>ISO</sub> for 5 V output or connect V <sub>SEL</sub> to GND <sub>ISO</sub> for 3.3 V output. This pin has a weak internal pull-up. Therefore, do not leave this pin floating. It is recommended that the ADuM5020-3BRWZ and the ADuM5028-3BRIZ are only used for 3.3 V input to 3.3 V operation, therefore connect V <sub>SEL</sub> to GND <sub>ISO</sub> .

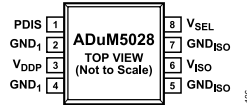


Figure 6. ADuM5028 Pin Configuration

Table 19. ADuM5028 Pin Function Descriptions

Pin No.	Mnemonic	Description
1	PDIS	Power Disable. When tied to any GND <sub>1</sub> pin, the V <sub>ISO</sub> output voltage is active. When a logic high voltage is applied, the V <sub>ISO</sub> output voltage is shut down. Do not leave this pin floating.
2, 4	GND <sub>1</sub>	Ground 1. Ground reference for the primary. It is recommended that these pins be connected to a common ground.
3	V <sub>DDP</sub>	Primary Supply Voltage.
5, 7	GND <sub>ISO</sub>	Ground Reference for V <sub>ISO</sub> on Side 2. It is recommended that these pins be connected together.
6	V <sub>ISO</sub>	Secondary Supply Voltage Output for External Loads.
8	V <sub>SEL</sub>	Output Voltage Selection. Connect V <sub>SEL</sub> to V <sub>ISO</sub> for 5 V output or connect V <sub>SEL</sub> to GND <sub>ISO</sub> for 3.3 V output. This pin has a weak internal pull-up; therefore, do not leave this pin floating. It is recommended that the ADuM5020-3BRWZ and the ADuM5028-3BRIZ are only used for 3.3 V input to 3.3 V operation, therefore connect V <sub>SEL</sub> to GND <sub>ISO</sub> .

Table 20. Truth Table (Positive Logic)

V <sub>DDP</sub> (V)	V <sub>SEL</sub> Input	PDIS Input	V <sub>ISO</sub> Output (V)	Notes
5	High	Low	5	
5	Low	Low	3.3	
5	Don't care	High	0	
3.3	Low	Low	3.3	
3.3	High	Low	5	Configuration not recommended
3.3	Don't care	High	0	

TYPICAL PERFORMANCE CHARACTERISTICS

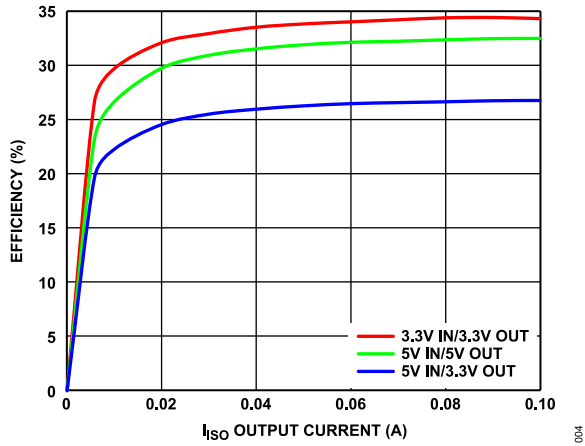


Figure 7. Typical Power Supply Efficiency in Supported Supply Configurations

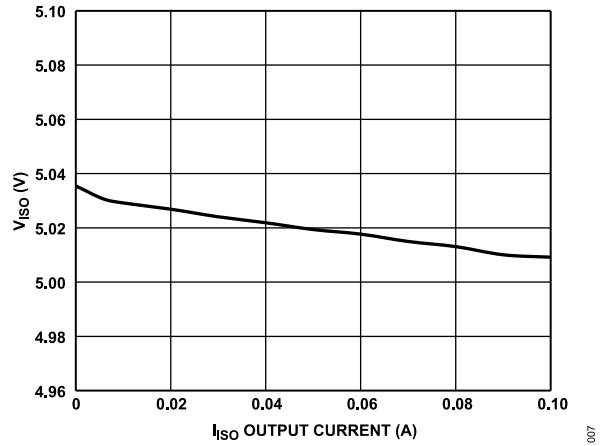


Figure 10.  $V_{ISO}$  vs.  $I_{ISO}$  Output Current, Input = 5 V,  $V_{ISO}$  = 5 V

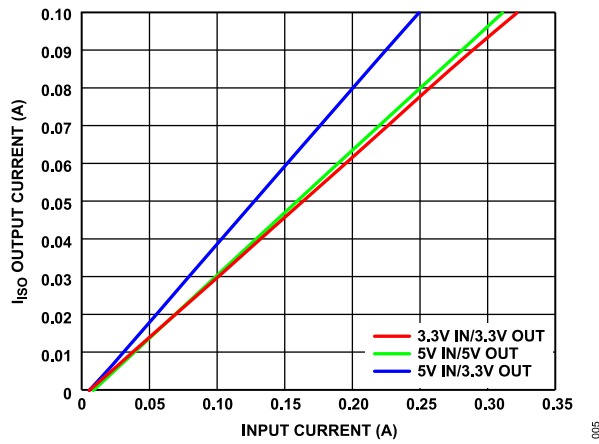


Figure 8.  $I_{ISO}$  Output Current vs. Input Current in Supported Power Configurations

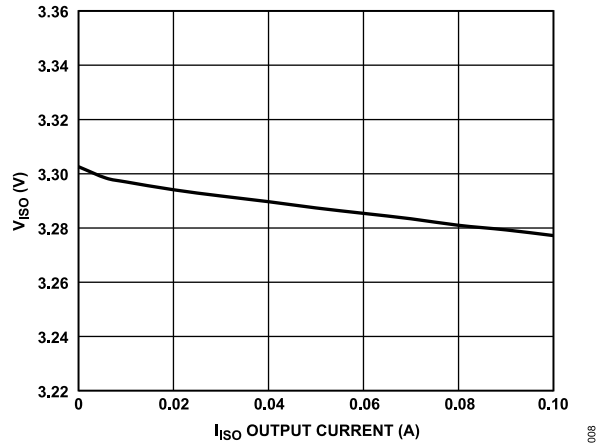


Figure 11.  $V_{ISO}$  vs.  $I_{ISO}$  Output Current, Input = 5 V,  $V_{ISO}$  = 3.3 V

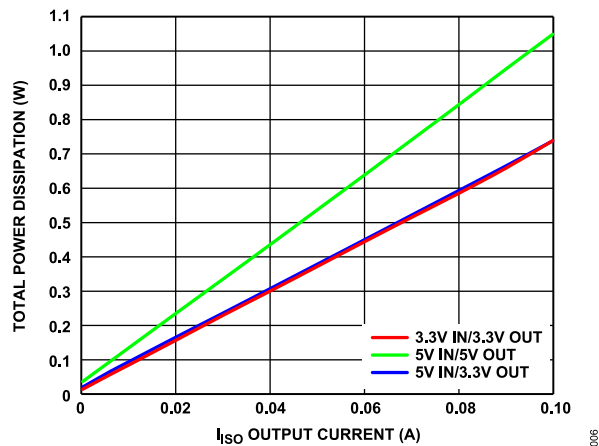


Figure 9. Total Power Dissipation vs.  $I_{ISO}$  Output Current in Supported Power Configurations

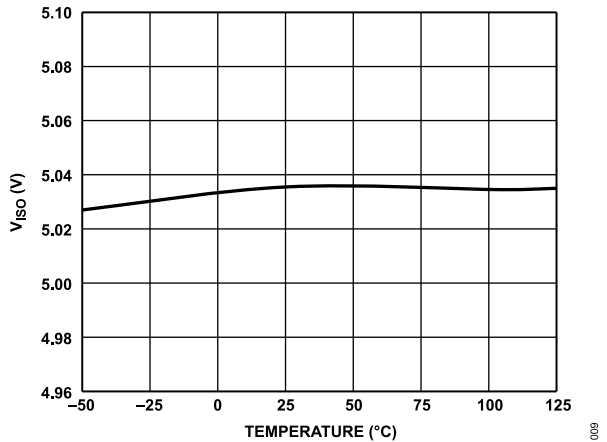


Figure 12.  $V_{ISO}$  vs. Temperature, Input = 5 V,  $V_{ISO}$  Output = 5 V

TYPICAL PERFORMANCE CHARACTERISTICS

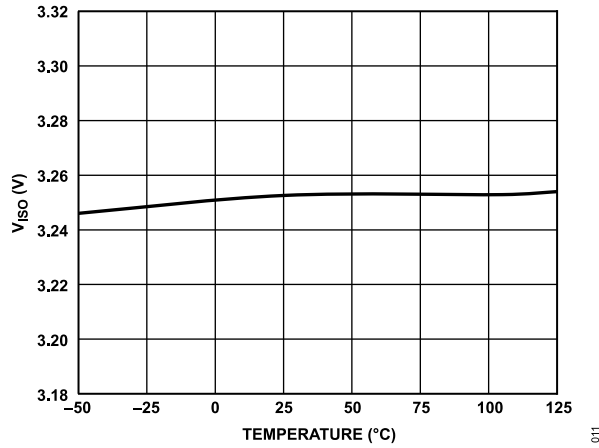


Figure 13.  $V_{ISO}$  vs. Temperature, Input = 3.3 V,  $V_{ISO}$  Output = 3.3 V

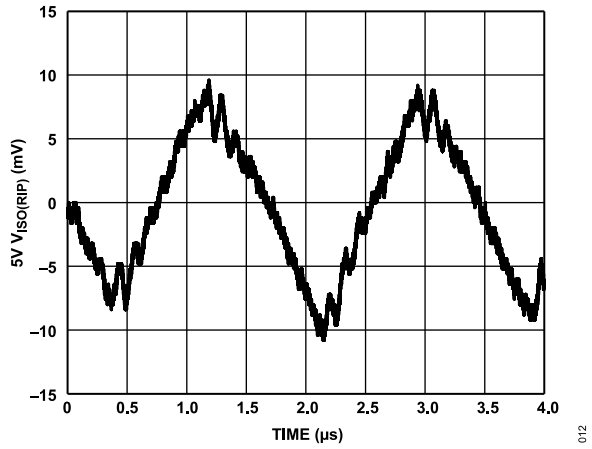


Figure 14.  $V_{ISO}$  Ripple, 5 V Input to 5 V Output at 90% Load, Bandwidth = 20 MHz

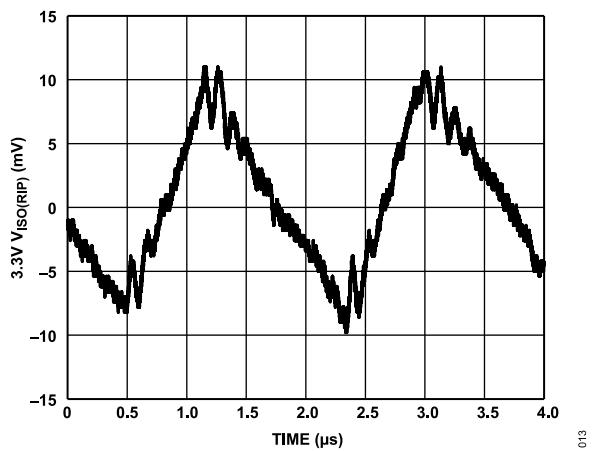


Figure 15.  $V_{ISO}$  Ripple, 5 V Input to 3.3 V Output at 90% Load, Bandwidth = 20 MHz

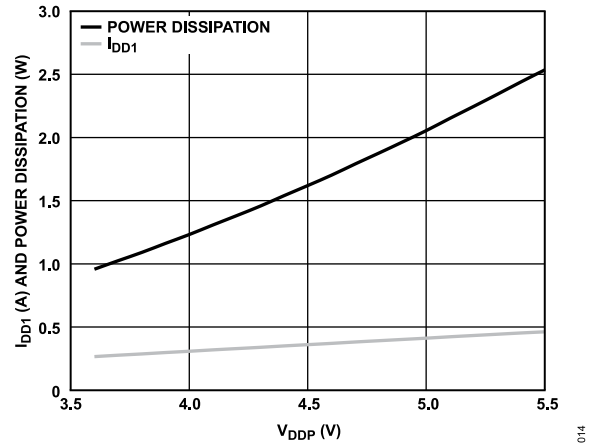


Figure 16. Short-Circuit Input Current ( $I_{DD1}$ ) and Power Dissipation vs.  $V_{DDP}$

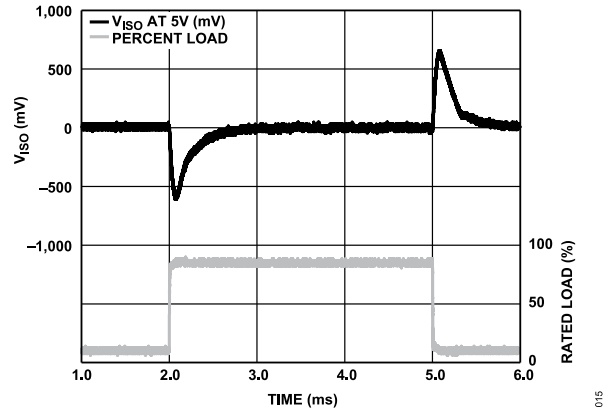


Figure 17.  $V_{ISO}$  Transient Load Response 5 V Input to 5 V Output 10% to 90% Load Step

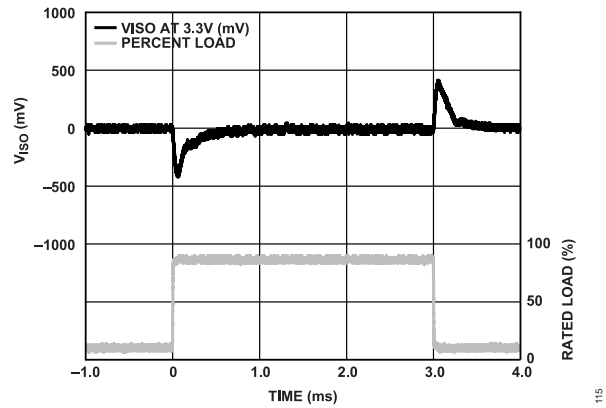


Figure 18.  $V_{ISO}$  Transient Load Response 5 V Input to 3.3 V Output, 10% to 90% Load Step

TYPICAL PERFORMANCE CHARACTERISTICS

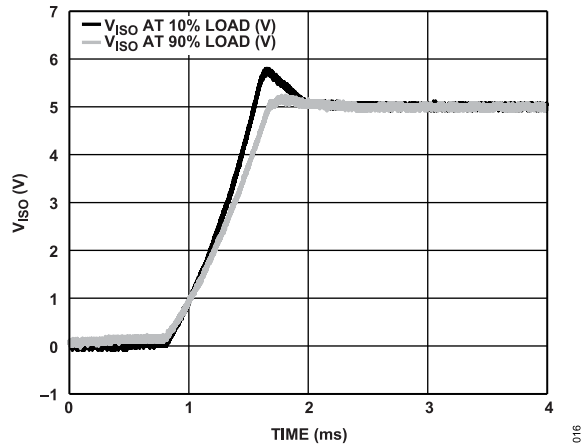


Figure 19. 5 V Input to 5 V Output V<sub>ISO</sub> Start-Up Transient at 10% and 90% Load

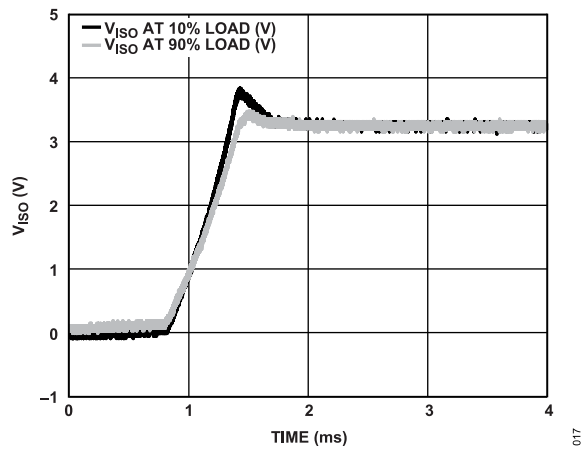


Figure 20. 5 V Input to 3.3 V Output V<sub>ISO</sub> Start-Up Transient at 10% and 90% Load

## THEORY OF OPERATION

The ADuM5020/ADuM5028 dc-to-dc work on principles that are common to most standard power supplies. The converters have a split controller architecture with isolated PWM feedback.  $V_{DDP}$  power is supplied to an oscillating circuit that switches current into a chip scale air core transformer. Power transferred to the secondary side is rectified and regulated to 3.3 V or 5.0 V, depending on the setting of the  $V_{SEL}$  pin. Note that the ADuM5020-3BRWZ and the ADuM5028-3BRIZ can only be used for 3.3 V input to 3.3 V output applications, and the ADuM5020-5BRWZ and ADuM5028-5BRIZ operate best for 5 V input applications. The secondary ( $V_{ISO}$ ) side controller regulates the output by creating a PWM control signal

that is sent to the primary ( $V_{DDP}$ ) side by a dedicated *iCoupler* data channel. The PWM modulates the oscillator circuit to control the power being sent to the secondary side. Feedback allows significantly higher power and efficiency.

The ADuM5020/ADuM5028 implement undervoltage lockout (UVLO) with hysteresis on the primary and secondary side input and output pins as well as the  $V_{DDP}$  power input. The UVLO feature ensures that the converters do not go into oscillation due to noisy input power or slow power-on ramp rates.



## APPLICATIONS INFORMATION

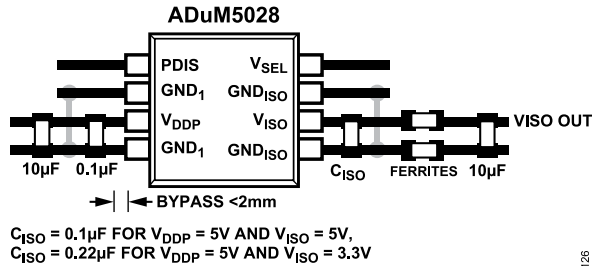


Figure 26. Recommended ADuM5028 PCB Layout

In applications involving high common-mode transients, ensure that board coupling across the isolation barrier is minimized. Furthermore, design the board layout such that any coupling that does occur equally affects all pins on a given component side. Failure to ensure these steps can cause voltage differentials between pins, exceeding the absolute maximum ratings specified in Table 16, thereby leading to latch-up or permanent damage.

## THERMAL ANALYSIS

The ADuM5020 and ADuM5028 each consist of three internal die attached to a split lead frame. For thermal analysis, the die is treated as a thermal unit, with the highest junction temperature reflected in the  $\theta_{JA}$  values, shown in Table 11 and Table 12. The value of  $\theta_{JA}$  is based on measurements taken with the devices mounted on a JEDEC standard, 4-layer board with fine width traces and still air. Under normal operating conditions, the ADuM5020 and ADuM5028 can operate at full load, but at temperatures greater than 85°C, derating the output current may be needed, as shown in Figure 3 and Figure 4.

## EMI CONSIDERATIONS

The ADuM5020/ADuM5028 dc-to-dc converters must, of necessity, operate at a high frequency to allow efficient power transfer through the small transformers. This high frequency operation creates high frequency currents that can propagate in circuit board ground and power planes, requiring proper power supply bypassing at the input and output supply pins (see Figure 25 and Figure 26). Using proper layout, bypassing techniques, and surface-mount ferrite beads in series with the  $V_{ISO}$  and  $GND_{ISO}$  pins, the dc-to-dc converters are designed to provide regulated, isolated power that is below CISPR22 Class B limits at full load on a 2-layer PCB with ferrites.

## INSULATION LIFETIME

All insulation structures eventually break down when subjected to voltage stress over a sufficiently long period. The rate of insulation degradation is dependent on the characteristics of the voltage waveform applied across the insulation, as well as on the materials and material interfaces.

The two types of insulation degradation of primary interest are breakdown along surfaces exposed to the air and insulation wear out. Surface breakdown is the phenomenon of surface tracking and the primary determinant of surface creepage requirements in

system level standards. Insulation wear out is the phenomenon where charge injection or displacement currents inside the insulation material cause long-term insulation degradation.

## Surface Tracking

Surface tracking is addressed in electrical safety standards by setting a minimum surface creepage based on the working voltage, the environmental conditions, and the properties of the insulation material. Safety agencies perform characterization testing on the surface insulation of components that allows the components to be categorized in different material groups. Lower material group ratings are more resistant to surface tracking and, therefore, can provide adequate lifetime with smaller creepage. The minimum creepage for a given working voltage and material group is in each system level standard and is based on the total rms voltage across the isolation, pollution degree, and material group. The material group and creepage for the ADuM5020 and ADuM5028 are presented in Table 9 and Table 10.

## Insulation Wear Out

The lifetime of insulation caused by wear out is determined by its thickness, material properties, and the voltage stress applied. It is important to verify that the product lifetime is adequate at the application working voltage. The working voltage supported by an isolator for wear out may not be the same as the working voltage supported for tracking. The working voltage applicable to tracking is specified in most standards.

Testing and modeling show that the primary driver of long-term degradation is displacement current in the polyimide insulation causing incremental damage. The stress on the insulation can be grouped into broad categories, such as dc stress, which causes very little wear out because there is no displacement current, and an ac component time varying voltage stress, which causes wear out.

The ratings in certification documents are usually based on a 60 Hz sinusoidal waveform because this stress reflects isolation from line voltage. However, many practical applications have combinations of 60 Hz ac and dc across the barrier as shown in Equation 1. Because only the ac portion of the stress causes wear out, the equation can be rearranged to solve for the ac rms voltage, as shown in Equation 2. For insulation wear out with the polyimide materials used in these products, the ac rms voltage determines the product lifetime.

$$V_{RMS} = \sqrt{V_{AC\ RMS}^2 + V_{DC}^2} \quad (1)$$

or

$$V_{AC\ RMS} = \sqrt{V_{RMS}^2 - V_{DC}^2} \quad (2)$$

where:

$V_{RMS}$  is the total rms working voltage.

$V_{AC\ RMS}$  is the time varying portion of the working voltage.

## APPLICATIONS INFORMATION

$V_{DC}$  is the dc offset of the working voltage.

### Calculation and Use of Parameters Example

The following example frequently arises in power conversion applications. Assume that the line voltage on one side of the isolation is 240 V ac rms and a 400 V dc bus voltage is present on the other side of the isolation barrier. The isolator material is polyimide. To establish the critical voltages in determining the creepage, clearance, and lifetime of a device, see [Figure 27](#) and the following equations.

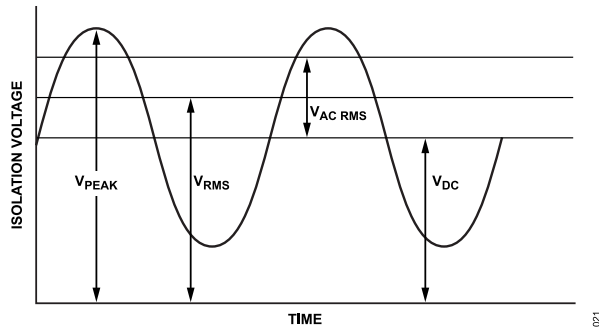


Figure 27. Critical Voltage Example

The working voltage across the barrier from Equation 1 is

$$V_{RMS} = \sqrt{V_{AC\ RMS}^2 + V_{DC}^2}$$

$$V_{RMS} = \sqrt{240^2 + 400^2}$$

$$V_{RMS} = 466\ \text{V}$$

This  $V_{RMS}$  value is the working voltage used together with the material group and pollution degree when looking up the creepage required by a system standard.

To determine if the lifetime is adequate, obtain the time varying portion of the working voltage. To obtain the ac rms voltage, use [Equation 2](#).

$$V_{AC\ RMS} = \sqrt{V_{RMS}^2 - V_{DC}^2}$$

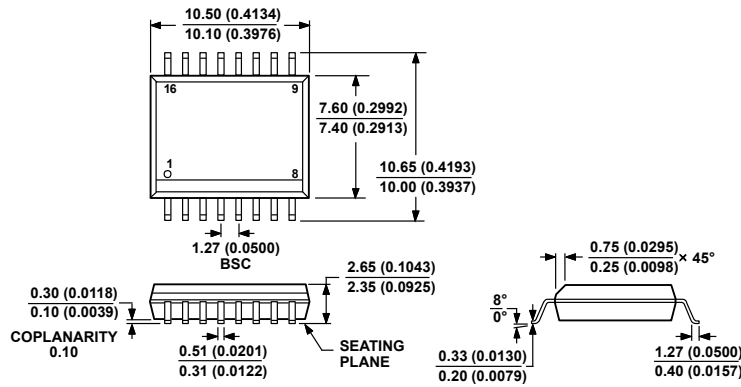
$$V_{AC\ RMS} = \sqrt{466^2 - 400^2}$$

$$V_{AC\ RMS} = 240\ \text{V rms}$$

In this case, the ac rms voltage is simply the line voltage of 240 V rms. This calculation is more relevant when the waveform is not sinusoidal. The value is compared to the limits for working voltage in [Table 17](#) for the expected lifetime, which is less than a 60 Hz sine wave, and it is well within the limit for a 50-year service life.

Note that the dc working voltage limit is set by the creepage of the package as specified in IEC 60664-1. This value can differ for specific system level standards.

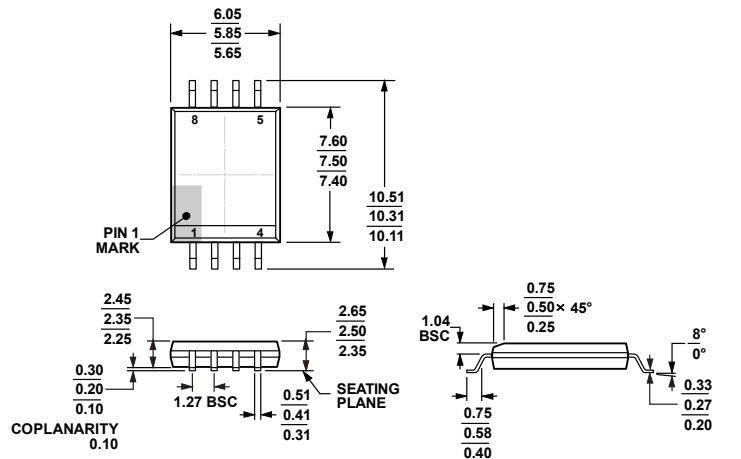
OUTLINE DIMENSIONS



COMPLIANT TO JEDEC STANDARDS MS-013-AA  
 CONTROLLING DIMENSIONS ARE IN MILLIMETERS; INCH DIMENSIONS  
 (IN PARENTHESES) ARE ROUNDED-OFF MILLIMETER EQUIVALENTS FOR  
 REFERENCE ONLY AND ARE NOT APPROPRIATE FOR USE IN DESIGN.

03-27-2007-B

Figure 28. 16-Lead Standard Small Outline Package [SOIC\_W]  
 Wide Body  
 (RW-16)  
 Dimensions shown in millimeters and (inches)



09-17-2014-B

Figure 29. 8-Lead Standard Small Outline Package, with Increased Creepage [SOIC\_IC]  
 Wide Body  
 (RI-8-1)  
 Dimensions shown in millimeters

Updated: November 03, 2023

ORDERING GUIDE

Table 22. Ordering Guide

Model <sup>1,2</sup>	Temperature Range	Package Description	Packing Quantity	Package Option
ADUM5020-3BRWZ	-40°C to +125°C	16-Lead SOIC Wide		RW-16
ADUM5020-3BRWZ-RL	-40°C to +125°C	16-Lead SOIC Wide	Reel, 1000	RW-16
ADUM5020-5BRWZ	-40°C to +125°C	16-Lead SOIC Wide		RW-16
ADUM5020-5BRWZ-RL	-40°C to +125°C	16-Lead SOIC Wide	Reel, 1000	RW-16

## OUTLINE DIMENSIONS

**Table 22. Ordering Guide (Continued)**

Model <sup>1,2</sup>	Temperature Range	Package Description	Packing Quantity	Package Option
ADUM5028-3BRIZ	-40°C to +125°C	8-Lead SOIC (Increased Creepage)		RI-8-1
ADUM5028-3BRIZ-RL	-40°C to +125°C	8-Lead SOIC (Increased Creepage)	Reel, 1500	RI-8-1
ADUM5028-5BRIZ	-40°C to +125°C	8-Lead SOIC (Increased Creepage)		RI-8-1
ADUM5028-5BRIZ-RL	-40°C to +125°C	8-Lead SOIC (Increased Creepage)	Reel, 1500	RI-8-1

<sup>1</sup> Z = RoHS Compliant Part.

<sup>2</sup> For 5 V input operations, use the ADuM5020-5BRWZ and ADuM5028-5BRIZ. For 3.3 V input to 3.3 V output operations, use the ADuM5020-3BRWZ and the ADuM5028-3BRIZ.

## EVALUATION BOARDS

Model <sup>1,2,3</sup>	Package Description
EVAL-ADuM5020EBZ	ADuM5020 Evaluation Board
EVAL-ADuM5028EBZ	ADuM5028 Evaluation Board

<sup>1</sup> Z = RoHS Compliant Part.

<sup>2</sup> The EVAL-ADuM5020EBZ is packaged with the ADuM5020-5BRWZ installed and can be used for evaluating the ADuM6020.

<sup>3</sup> The EVAL-ADuM5028EBZ is packaged with the ADuM5028-5BRIZ installed and can be used for evaluating the ADuM6028.

## Looking for pricing, stock, or lifecycle information?

Click below to explore more details on WIN SOURCE:

- ⊖ [View ADUM5028-5BRIZ on WIN SOURCE](#)
- ⊖ [Analog Devices Inc. Information](#)

## Optimize Your Supply Chain with WIN SOURCE Solutions

- ✓ Global Sourcing Solution
- ✓ Obsolete Management
- ✓ Cost Control Management
- ✓ Shortage Management
- ✓ Alternative Solution
- ✓ Excess Inventory Management