



## General Description

The AOZ1375DI is a bidirectional current-limited load switch intended for applications that require circuit protections. The device operates from voltages between 3.4V and 23V and features two power terminals, VINT and VBUS, which are rated at 28V Absolute Maximum. When used as source switch, the internal current limiting circuit protects the supply from large load current. The current limit can be set with an external resistor. The back-to-back switch configuration blocks any leakage between VINT and VBUS pins when the device is disabled.

The AOZ1375DI provides over-voltage protection, short-circuit protection and thermal protection function that limit excessive power dissipation. The over-voltage protection threshold is selectable by an external resistor. The internal soft-start circuitry controls inrush current due to highly capacitive loads. The soft-start can be adjusted using an external capacitor. It consumes less than 5μA in shutdown.

The AOZ1375DI-01 is available in a 3mm x 3mm DFN-12L package which can operate over -40°C to +85°C temperature range.

## Features

- 17.8mΩ typical ON resistance
- 3.4V to 23V operating input voltage
- VINT and VBUS are both rated 28V
- Bidirectional operation
- Reverse blocking to completely isolate VINT and VBUS when disabled
- Programmable current limit
- Short-circuit protection
- Selectable over-voltage protection
- Programmable soft-start
- Under-voltage lockout
- Over-voltage lockout
- Thermal shutdown protection
- ±4kV HBM ESD rating
- ±8kV HBM ESD rating for VBUS and VINT
- DFN3x3-12L package
- UL 2367: file no. E495859
- IEC 62368-1: file no. E326264.

## Applications

- Thunderbolt/USB Type-C PD power switch
- Notebook/desktop
- Monitors
- Docking station/dongles



## Typical Application

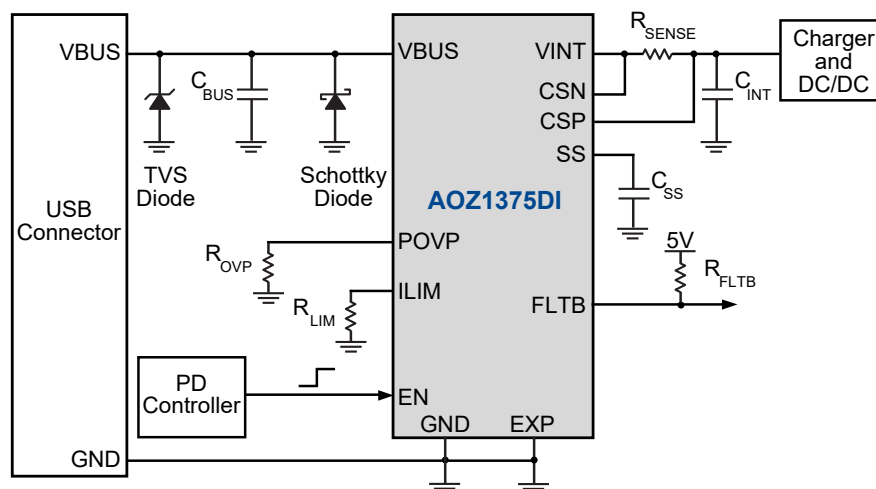

## Ordering Information

Part Number	Fault Recovery	Temperature Range	Package	Environmental
AOZ1375DI-01	Auto-Restart	-40°C to +85°C	3mm x 3mm DFN-12L	RoHS
AOZ1375DI-02	Latch-Off	-40°C to +85°C	3mm x 3mm DFN-12L	RoHS



AOS products are offered in packages with Pb-free plating and compliant to RoHS standards. Please visit [www.aosmd.com/media/AOSGreenPolicy.pdf](http://www.aosmd.com/media/AOSGreenPolicy.pdf) for additional information.

## Pin Configuration

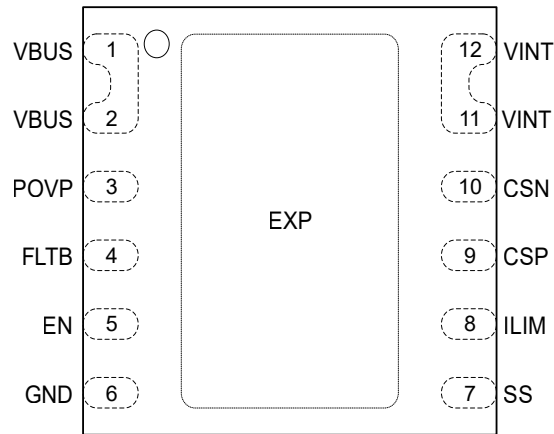

DFN3x3-12L  
(Top Transparent View)

## Pin Description

Pin Number	Pin Name	Pin Function
1, 2	VBUS	Adapter supply input or output to periphery. Connect to VBUS Connector.
3	POVP	Programmable over voltage protection. Connect a resistor $R_{OVP}$ from POVP to GND.
4	FLTB	Fault Indicator, Open Drain output. Active Low when fault condition occurs.
5	EN	Enable Input.
6	GND	Ground.
7	SS	Soft-start pin. Connect a capacitor $C_{SS}$ from SS to GND to set the soft-start time.
8	ILIM	Current limit set pin. Connect a resistor $R_{LIM}$ from ILIM to GND to set the switch current limit.
9	CSP	Current sense positive input, connect to a 10mΩ for accurate current sensing. Short to VINT if current limit is not required.
10	CSN	Current sense negative input, connect to a 10mΩ for accurate current sensing. Short to VINT if current limit is not required.
11, 12	VINT	Connect to internal power source or load.
EXP	EXP	Exposed Thermal Pad. Connect to GND. Solder to a metal surface directly underneath the EXP and connect to PCB ground on multiple layers through vias. For best thermal performance make the ground copper pads as large as possible and connect to EXP with multiple vias.

## Absolute Maximum Ratings<sup>(1)</sup>

Exceeding the Absolute Maximum ratings may damage the device.

Parameter	Rating
VINT, VBUS, CSP, CSN, to GND	-0.3V to +28V
VINT-CSP, VINT-CSN, CSP-CSN	-0.3V to +0.3V
EN, ILIM, SS, FLT, POVP to GND	-0.3V to +6V
Junction Temperature (T <sub>J</sub> )	+150 °C
Storage Temperature (T <sub>S</sub> )	-65°C to +150°C
ESD Rating HBM All Pins <sup>(1)</sup>	±4kV
ESD Rating HBM VBUS/VINT	±8kV

### Note:

1. Devices are inherently ESD sensitive, handling precautions are required. Human body model is a 100pF capacitor discharging through a 1.5kΩ resistor.

## Recommended Operating Conditions

The device is not guaranteed to operate beyond the Maximum Recommended Operating Conditions.

Parameter	Rating
Supply Voltage (VINT, VBUS)	3.4V to 23V
EN, FLT	0V to 5.5V
POVP	0V to 3V
DC Switch Current (I <sub>SW</sub> )	0A to 8A
Peak Switch Current (I <sub>SW_PK</sub> ) for 10ms @ 2% Duty Cycle	20A
Ambient Temperature (T <sub>A</sub> )	-40°C to +85°C
Package Thermal Resistance DFN3x3-12L (Θ <sub>JA</sub> )	50 °C/W

## Electrical Characteristics

T<sub>A</sub> = 25°C, V<sub>IN</sub> = 20V, unless otherwise specified.

Symbol	Parameter	Conditions	Min	Typ	Max	Units
V <sub>VINT</sub>	Input Supply Voltage	VINT is input and VBUS is output	3.4		23	V
V <sub>VBUS</sub>		VBUS is input and VINT is output	3.4		23	
V <sub>UVLO</sub>	Under-voltage Lockout Threshold	VIN rising, VBUS is output	3.0		3.35	V
		VBUS rising, VINT is output	3.0		3.35	
V <sub>UVLO_HYS</sub>	Under-voltage Lockout Hysteresis	VINT falling, VBUS is output		0.25		V
		VBUS falling, VINT is output		0.25		
V <sub>OVLO_VINT</sub> V <sub>OVLO_VBUS</sub>	Over-voltage Lockout Threshold	R <sub>OVP</sub> = 20kΩ, 1%	23.0	24.0	25.0	V
		R <sub>OVP</sub> = 75kΩ, 1%	16.8	17.4	18.0	
		R <sub>OVP</sub> = 137kΩ, 1%	10.0	10.4	10.8	
		R <sub>OVP</sub> = 301kΩ, 1%	6.2	6.4	6.6	
V <sub>OVLO_HYS</sub>	Over-voltage Lockout Hysteresis	VINT and VBUS		300		mV
t <sub>D_OVP</sub>	Over-voltage Turn-off Delay	VINT and VBUS		1		μs
I <sub>VINT_ON</sub>	Input Quiescent Current	VINT = 20V, I <sub>VBUS</sub> = 0A, EN = 5V		550		μA
I <sub>VBUS_ON</sub>		VBUS = 20V, I <sub>VINT</sub> = 0A, EN = 5V				
I <sub>VINT_OFF</sub>	Input Shutdown Current	VINT = 20V, VBUS = Float, EN = 0V		2	5	μA
I <sub>VBUS_OFF</sub>	Output Leakage Current	VBUS = 20V, VINT = Float, EN = 0V		2	5	
R <sub>ON</sub>	Switch On Resistance	VINT = 20V, I <sub>VBUS</sub> = 1A, R <sub>LIM</sub> = 30kΩ		17.8		mΩ
		VINT = 5V, I <sub>VBUS</sub> = 1A, R <sub>LIM</sub> = 30kΩ		18.2		

**Electrical Characteristics (Continued)**
 $T_A = 25^\circ\text{C}$ ,  $V_{IN} = 20\text{V}$ , unless otherwise specified.

Symbol	Parameter	Conditions	Min	Typ	Max	Units
$I_{LIMIT}$	Current Limit <sup>(2)</sup>	$R_{LIM} = 68\text{k}\Omega$ (1% Tolerance) $R_{SENSE} = 10\text{m}\Omega$ (1% Tolerance)	2.0	2.35	2.7	A
		$R_{LIM} = 47\text{k}\Omega$ (1% Tolerance) $R_{SENSE} = 10\text{m}\Omega$ (1% Tolerance)	3.0	3.4	3.8	
		$R_{LIM} = 30\text{k}\Omega$ (1% Tolerance) $R_{SENSE} = 10\text{m}\Omega$ (1% Tolerance)	5.0	5.3	5.6	
$V_{EN\_H}$	Enable Input High Voltage		1.4			V
$V_{EN\_L}$	Enable Input Low Voltage				0.6	V
$I_{EN\_BIAS}$	Enable Input Bias Current	$EN = 1.8\text{V}$		4	10	$\mu\text{A}$
$V_{FLT\_LO}$	Fault Pull-down Voltage	$I_{SINK} = 3\text{mA}$			0.3	V
$t_{D\_ON}$	Turn-On Delay Time EN to VBUS (10% of VINT)	EN to 10% of VINT, VINT = 20V, CVBUS = 68 $\mu\text{F}$ , CSS = 1nF		1600		$\mu\text{s}$
$t_{ON}$	Turn-On Rise Time VBUS from 10% to 90%	VBUS rising from 10% to 90% of VINT, VINT = 20V, CVBUS = 68 $\mu\text{F}$ , CSS = 1nF		400		$\mu\text{s}$
$V_{SCP}$	Short-Circuit Protection	VINT - VBUS when VINT = 20V		5		V
$T_{SD}$	Thermal Shutdown Threshold			140		$^\circ\text{C}$
$T_{SD\_HYS}$	Thermal Shutdown Hysteresis			35		$^\circ\text{C}$
$t_{OCP}$	Over Current Response Time	Over current to switch disabled		1		ms
$t_{D\_FLT}$	FLT Delay	The time of occurrence of over current to FLT going low		500		$\mu\text{s}$
$t_{REC}$	FLT Recover Time	Fault is removed		64		ms

**Note:**

2. Configured such that VINT is input and VBUS is output.

## Functional Block Diagram

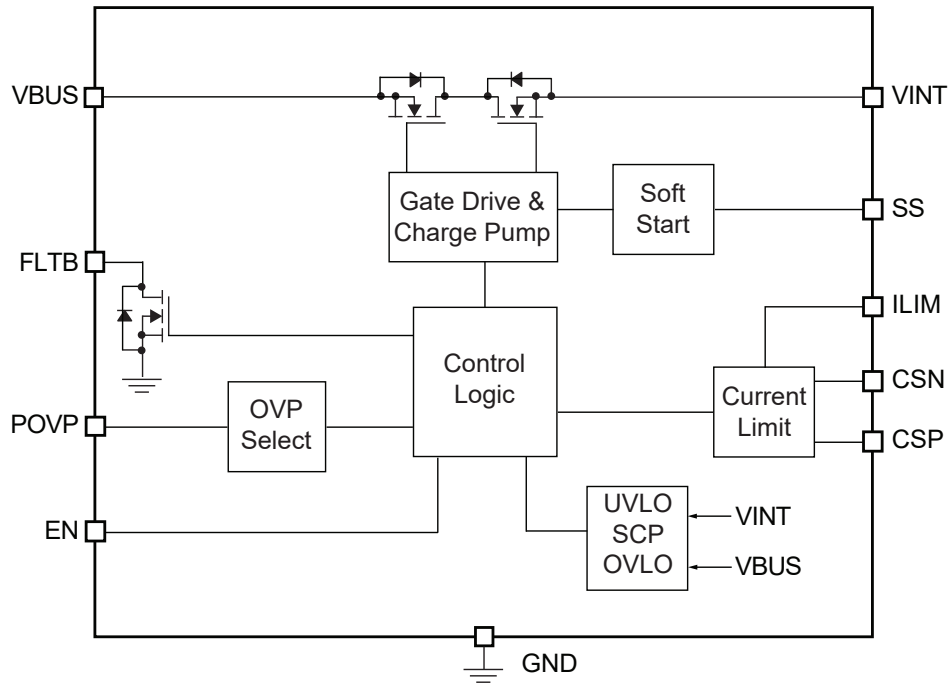

## Timing Diagrams

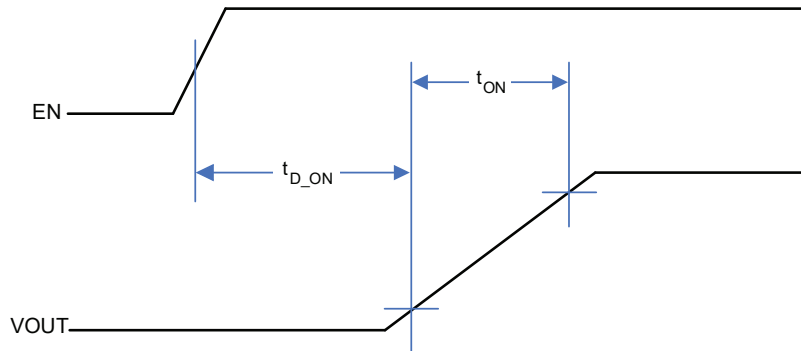

Figure 1. Turn-on Delay and Turn-on Time

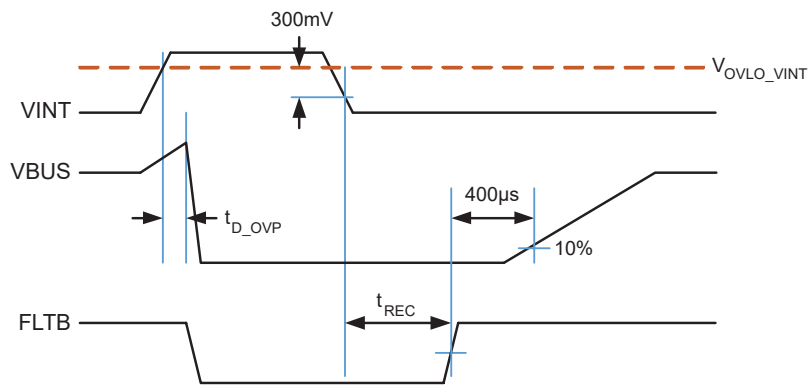

Figure 2. OVP Delay and Recovery Time for VINT OVP (AOZ1375DI-01)  
Same response for VBUS OVP with VINT and VBUS exchange

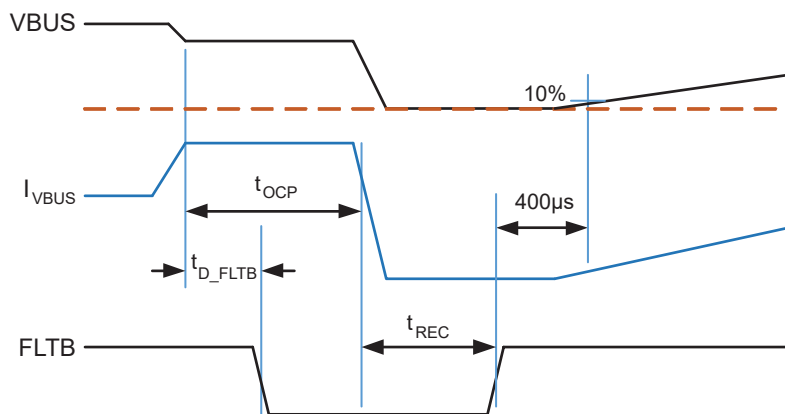
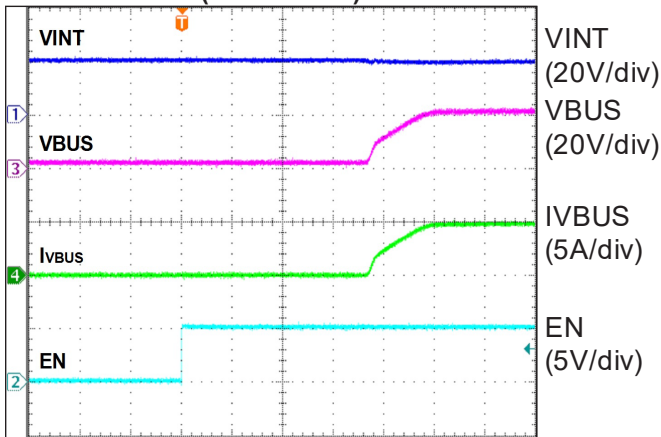

Figure 3. OCP and FLT\_B Time

## Typical Characteristics

$C_{IN} = 20\mu\text{F}$ ,  $C_{OUT} = 120\mu\text{F}$ ,  $R_{LOAD} = 100\Omega$ ,  $C_{SS} = 5.6\text{nF}$ ,  $POVP = 0\text{V}$ , unless otherwise specified.

Turn-On by EN  
(VINT = 20V)



400 $\mu\text{s}$ /div

Turn-On by EN  
(VINT = 5V)

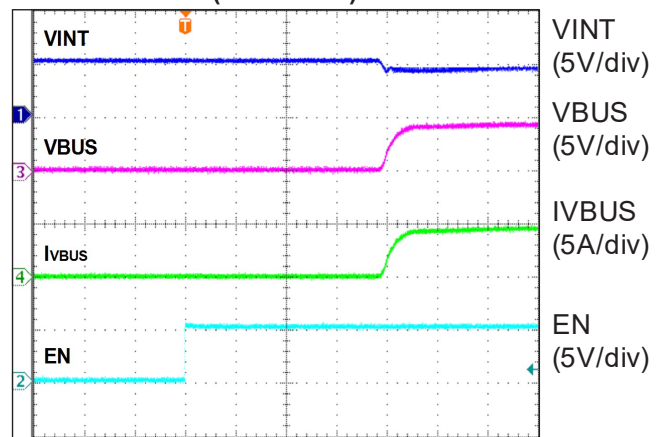

400 $\mu\text{s}$ /div

Turn-Off by EN  
(VINT = 20V)

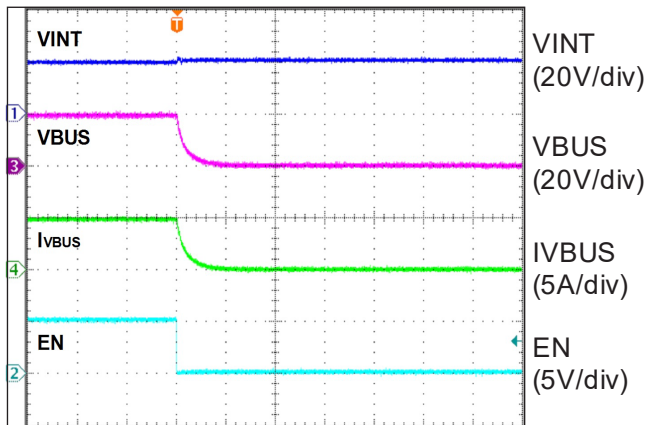

400 $\mu\text{s}$ /div

Turn-Off by EN  
(VINT = 5V)

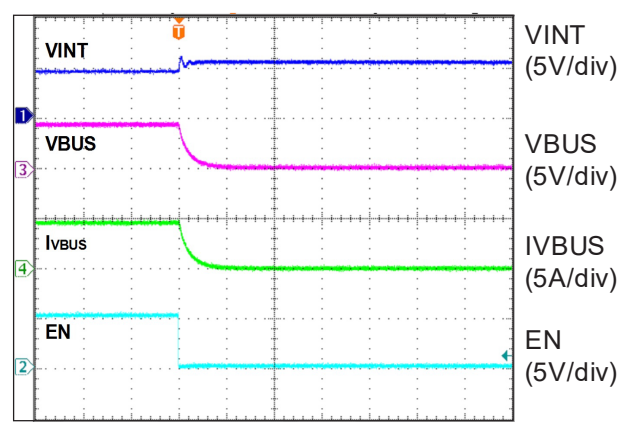

10ms/div

VINT OVP Operation  
with  $R_{OVP} = 20\text{k}\Omega$

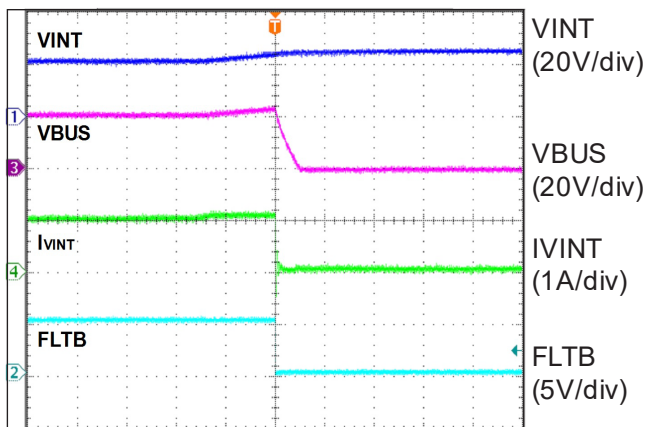

2 $\mu\text{s}$ /div

VINT OVP Operation  
with  $R_{OVP} = 301\text{k}\Omega$

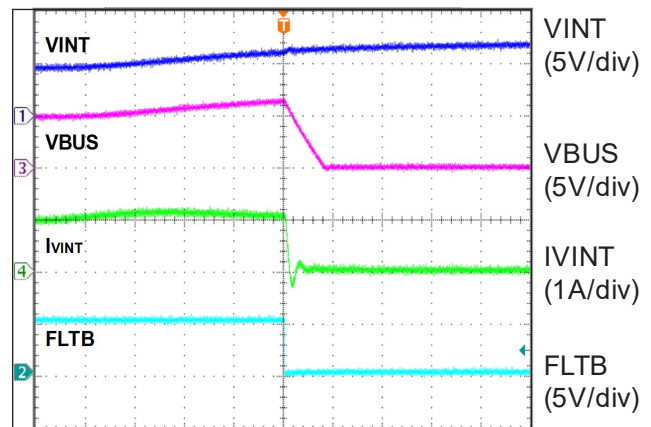

2 $\mu\text{s}$ /div

Typical Characteristics (Continued)

$C_{IN} = 20\mu F$ ,  $C_{OUT} = 120\mu F$ ,  $R_{LOAD} = 100\Omega$ ,  $C_{SS} = 5.6nF$ ,  $POVP = 0V$ , unless otherwise specified.

Over-Current Protection  
( $V_{INT} = 20V$ ,  $R_{LIM} = 30k\Omega$ )

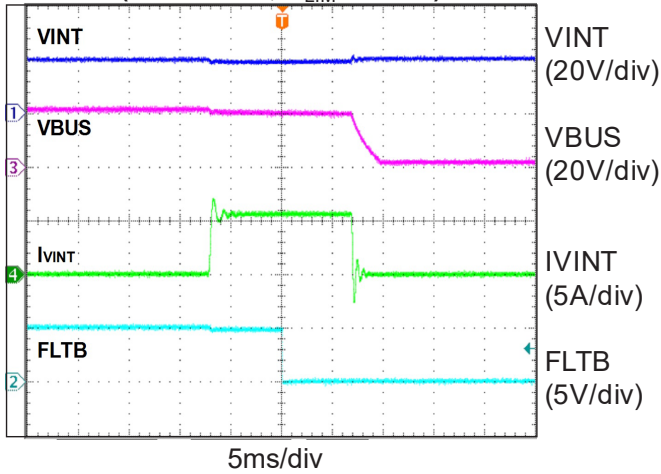

Over-Current Protection  
( $V_{INT} = 5V$ ,  $R_{LIM} = 30k\Omega$ )

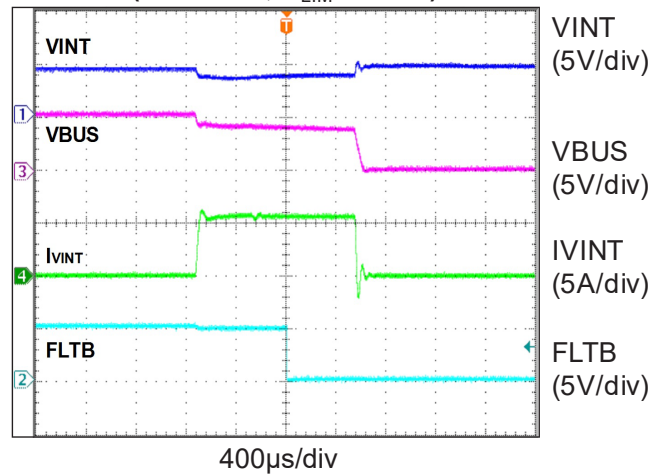

Short-Circuit Protection  
( $V_{INT} = 20V$ ,  $R_{LIM} = 30k\Omega$ ) (Auto-Restart)

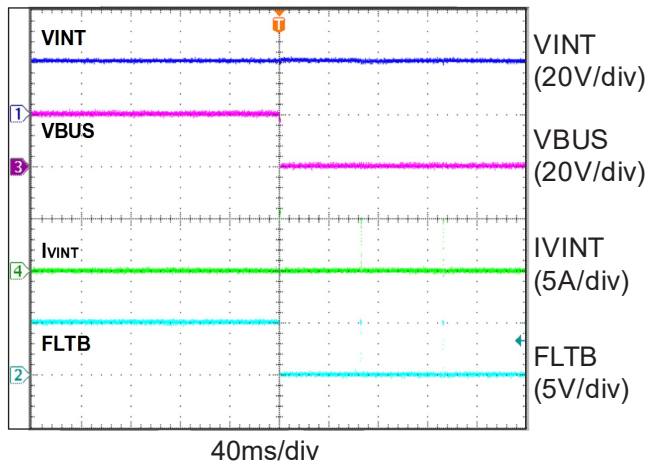

Short-Circuit Protection  
( $V_{INT} = 5V$ ,  $R_{LIM} = 30k\Omega$ ) (Auto-Restart)

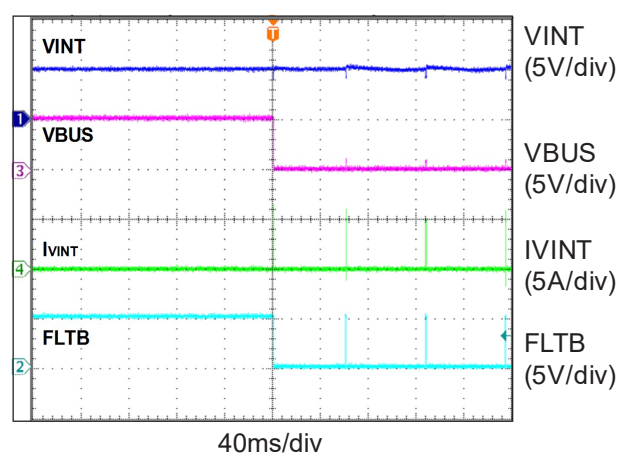

## Typical Characteristics

$T_A = 25\text{ }^\circ\text{C}$ , unless otherwise specified.

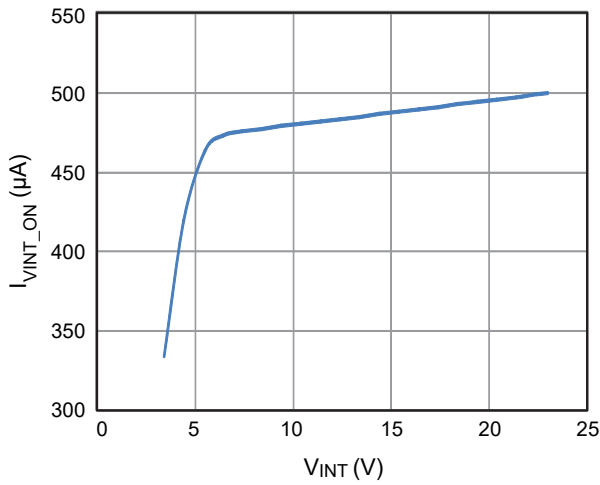

Figure 4. VINT Quiescent Current vs. VINT Voltage

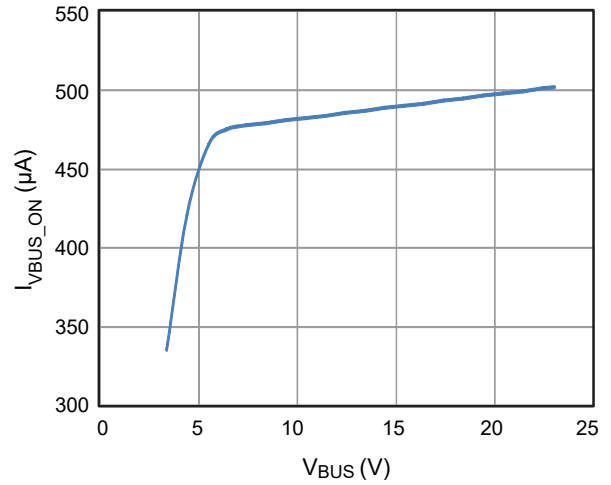

Figure 5. VBUS Quiescent Current vs. VBUS Voltage

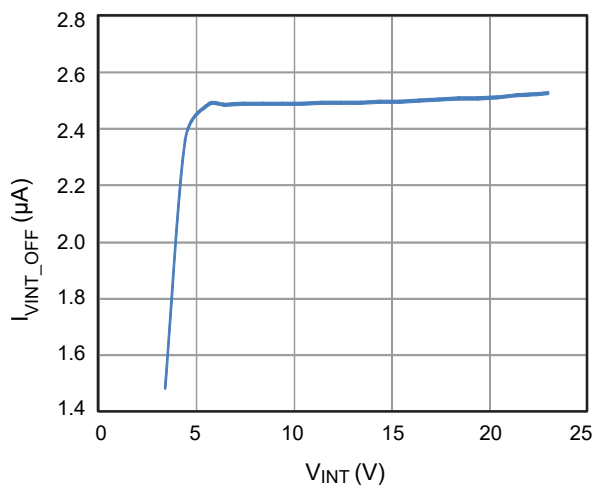

Figure 6. VINT Shutdown Current vs. VINT Voltage

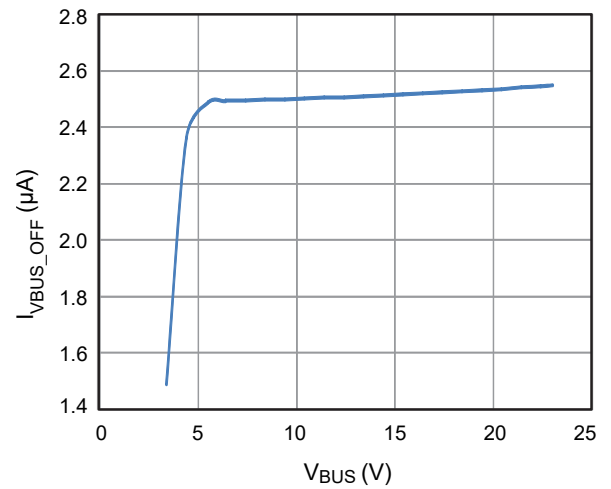

Figure 7. VBUS Shutdown Current vs. VBUS Voltage

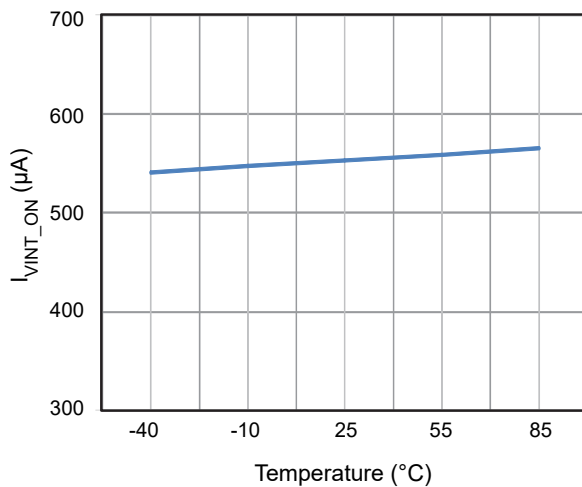

Figure 8. VINT Quiescent Current vs. Temperature (VINT = 20V)

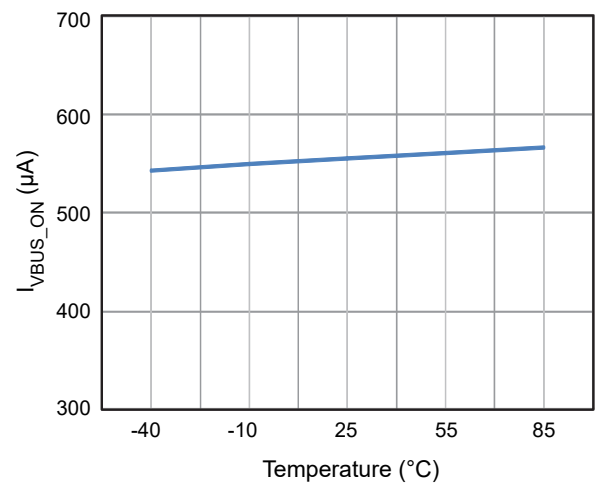

Figure 9. VBUS Quiescent Current vs. Temperature (VBUS = 20V)

Typical Characteristics (Continued)

T<sub>A</sub> = 25 °C, unless otherwise specified.

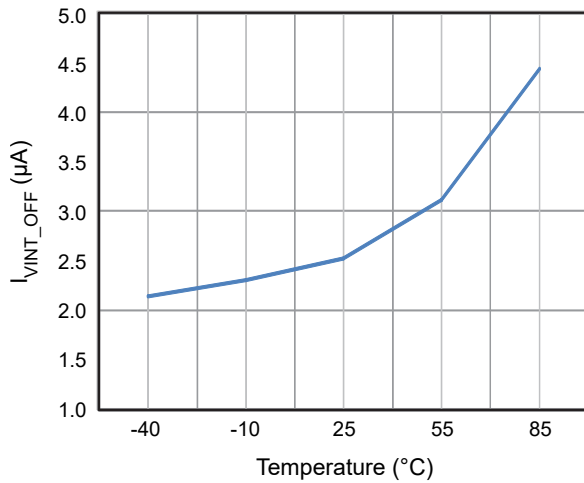

Figure 10. VINT Shutdown Current vs. Temperature (VINT = 20V)

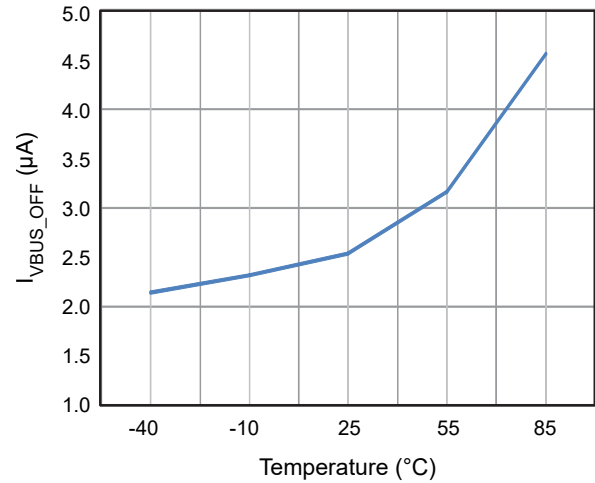

Figure 11. VBUS Shutdown Current vs. Temperature (VBUS = 20V)

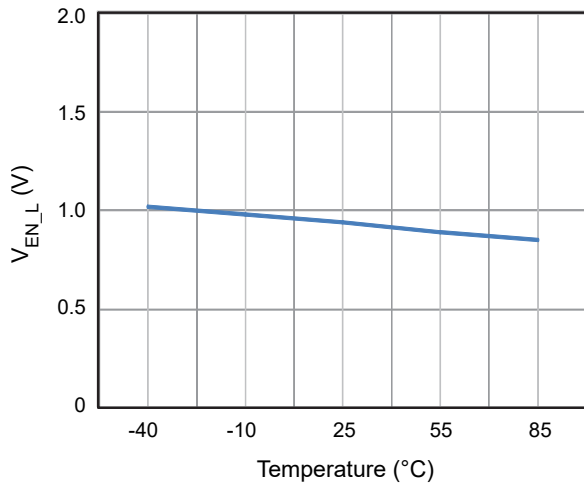

Figure 12. Enable Input Low Voltage vs. Temperature

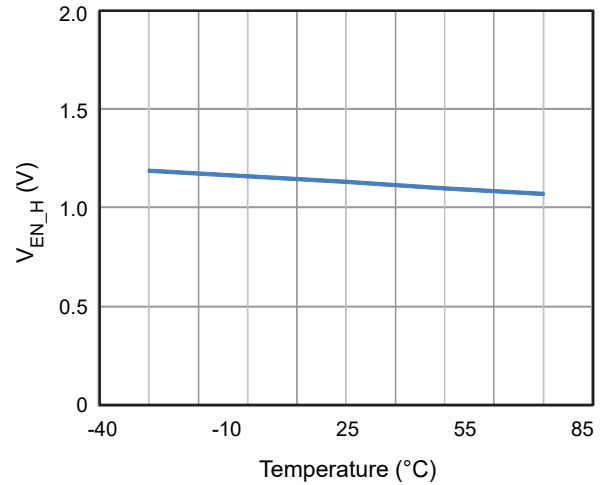

Figure 13. Enable Input High Voltage vs. Temperature

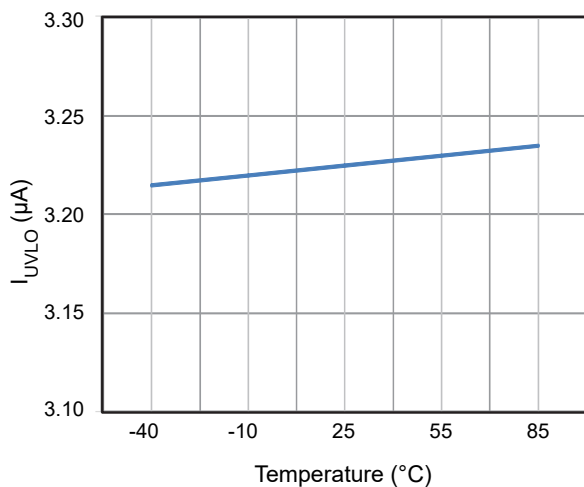

Figure 14. UVLO Rise Voltage (VINT) vs. Temperature

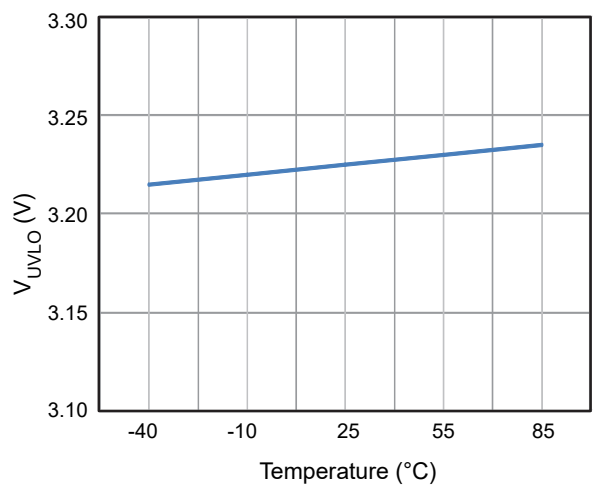

Figure 15. UVLO Rise Voltage (VBUS) vs. Temperature

Typical Characteristics (Continued)

T<sub>A</sub> = 25 °C, unless otherwise specified.

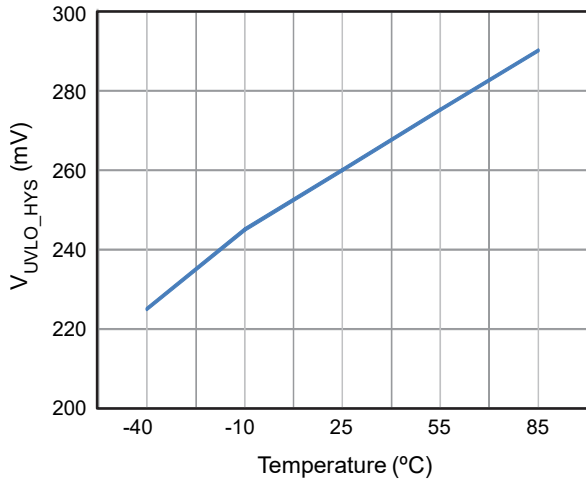

Figure 16. UVLO Hysteresis Voltage (VINT) vs. Temperature

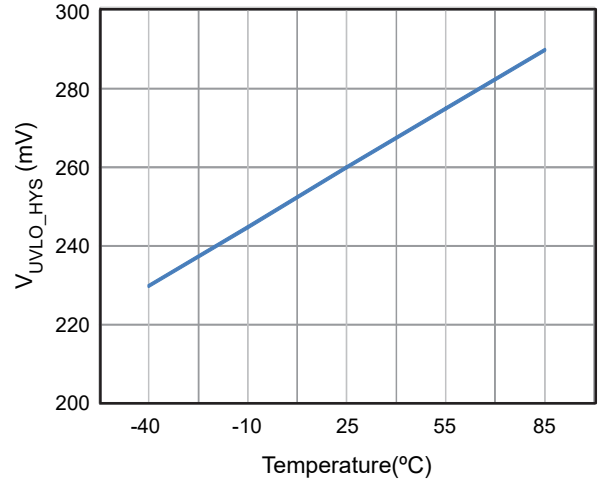

Figure 17. UVLO Hysteresis Voltage (VBUS) vs. Temperature

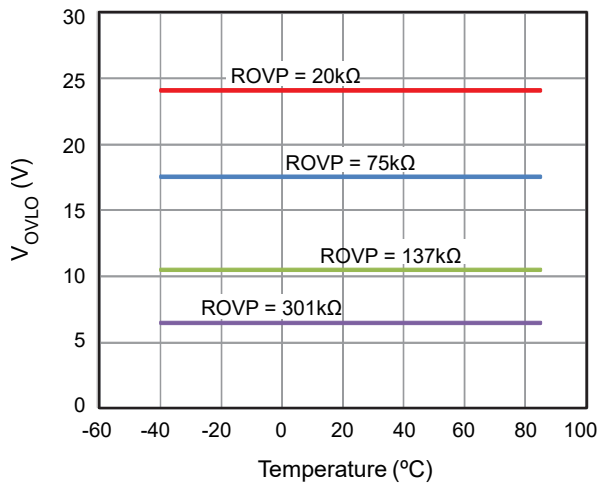

Figure 18. VINT OVP vs. Temperature

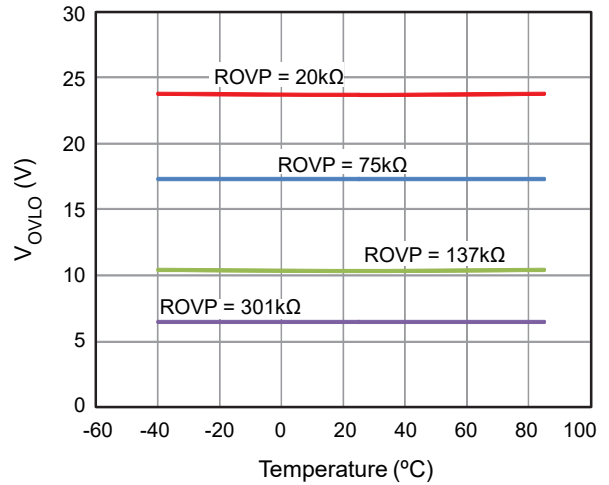

Figure 19. VBUS OVP vs. Temperature

## Detailed Description

AOZ1375DI is a high-side load switch with adjustable soft-start, over current limit, over-voltage, over temperature and short-circuit protections. It is capable of operating from 3.4V to 23V and rated up to 5A.

AOZ1375DI can be operated as bidirectional switch. As a source switch it can pass power from VINT to the VBUS. As a sink switch, it can pass supply from VBUS to VINT. The devices automatically select power from either VINT or VBUS whichever is higher.

The power switch consists of 2 back-to-back connected N-channel MOSFETs. When switch is enabled, the overall resistance between VINT and VBUS is only 17.8mΩ in typical condition, minimizing power loss and thermal dissipation. The back-to-back configuration of switches completely isolates between VINT and VBUS when turned off, preventing leakage between the two pins.

### Enable

The EN pin is the ON/OFF control for the power switch. The device is enabled when EN pin is high and device is not in UVLO lockout state. The EN pin must be driven to a logic high or logic low state to guarantee operation. While disabled, the AOZ1375DI only draws about 2μA supply current.

### Input Under-Voltage Lockout (UVLO)

The internal circuitry of AOZ1375DI is powered from either VBUS or VINT. The under-voltage lockout (UVLO) circuit of AOZ1375DI monitors the voltage at both pins and only allows the power switches to turn on when VINT or VBUS is higher than 3.4V. If both pins are below 3.4V, the device is in under-voltage lockout state.

### Programmable Over-Voltage Protection (OVP)

The voltages at both VINT and VBUS pins are constantly monitored once the device is enabled. In case voltage on either pin exceeds the programmed threshold, over-voltage protection is activated:

- 1) If the power switch is on, it will be turned off immediately to isolate VINT from VBUS;
- 2) OVP will prevent power switch to be turned on if it is in off state.

In either case FLTB pin is pulled low to report the fault condition.

An external resistor  $R_{OVP}$  connected between POVP and GND pins sets the over-voltage protection threshold. An internal 8μA current source biases POVP pin. The voltage drop across resistor  $R_{OVP}$  is detected by comparators that sets the OVP threshold based on the table below:

Table 1. OVP Setting by External Resistor

$R_{OVP}$ Resistor Value (1%)	OVP Threshold
≤20K	24V
75K	17.4V
137K	10.4V
≥301K	6.4V

### Programmable Over-Current Protection (OCP)

AOZ1375DI implemented current limit to ensure that the current through the switch does not exceed the programmed value. The current passes through the switch is sensed using external sense resistor  $R_{SENSE}$ . Current limit is programmed by an external resistor  $R_{LIM}$  connected between ILIM and GND. If over-load occur, the internal circuitry will limit the output current based on the value of  $R_{LIM}$ .

The current limit threshold can be calculated according to equation below for  $R_{SENSE} = 10m\Omega$ :

$$Current\ Limit = \frac{160}{(R_{LIM})(k\Omega)} (A)$$

For example, for 3.4A current limit, a 47kΩ  $R_{LIM}$  should be selected.

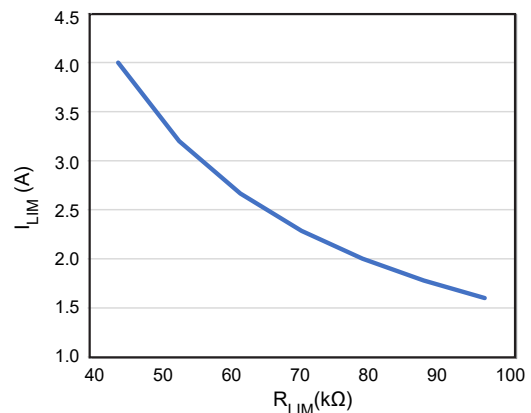

Figure 20. Current Limit Vs  $R_{LIM}$

The current limit threshold should be within 1A to 6A. Current limit accuracy or functionality is not guaranteed beyond this range. 1% resistors are recommended for both  $R_{SENSE}$  and  $R_{LIM}$ .

When AOZ1375DI is under current-limiting, FLTB is pulled low after 500μs delay. The load switch will then open if the device is still current-limiting after an additional 500μs delay.

There is no current limiting function when configured as sink switch (current flow from VBUS to VINT), but VINT startup rise time is still controlled by the SS pin.

If current limit function is not used, both CSP and CSN pins must be connected to VINT.

### Short-Circuit Protection (SCP)

AOZ1375DI implemented short-circuit protection to quickly turn off the power switch when output is severely overloaded. A comparator monitors the voltage drop between VINT and VBUS when switch is closed. Short-circuit protection is activated when the above voltage difference reaches approximately 75% of VINT. Short-circuit protection functions in either sourcing or sinking configuration.

Short-circuit protection is not active until soft-start is completed.

### Thermal Shutdown Protection

During current limit or short-circuit, the power switch resistance is increased to limit the load current. This increases device power dissipation dramatically and causes the die temperature to rise. When the die temperature reaches 140°C the power switch is turned off. There is a 35°C hysteresis. Over-temperature fault is removed when die temperature drops below approximately 105°C.

### Soft-Start

When EN pin is asserted high, the soft-start control circuitry applies voltage on the gate of the power switch in a manner such that the output voltage is ramped up linearly until it reaches input voltage level. The soft-start can be adjusted by an external capacitor  $C_{SS}$  connected between SS pin and ground. The soft-start can be approximately set by the following equation:

$$t_{SS} = \left( \frac{V_{VIN}}{V_{OVP}} \right) \times \left( \left( \frac{C_{SS}}{0.0023} \right) - 100 \right)$$

Where, VIN is in volts and  $C_{SS}$  is in nF and  $t_{SS}$  is in  $\mu$ s. Where  $V_{OVP} = 24V$ . The recommended  $C_{SS}$  value is 1.0nF~1.5nF. The  $C_{SS}$  should less than 1.5nF.

The actual soft-start also depends on the output capacitance and current limit setting if in-rush current reaches current-limit level.

### System Startup

The device is enabled when  $EN \geq 1.4V$  and either VBUS or VINT is higher than UVLO threshold. The OVP threshold is first selected by sensing POVP voltage set by ROVP. The

device will then check if fault condition exist. When no fault exists, the power switch is turned on and the output is then ramped up, controlled by the soft-start and current limiting circuitry till it reaches input voltage.

### Fault Protection

AOZ1375DI protects its load from the following fault conditions: over-voltage, over-current, short-circuit, and over-temperature.

When device is first enabled, the power switch is off and fault conditions are checked. If voltage at VBUS or VINT is higher than the OVP threshold, or die temperature is higher than thermal shutdown threshold. FLTB pin is pulled low to report to host controller.

After the power switch turned on, device continuously monitors all fault conditions. The switch is turned off when OVP, short-circuit, or over-temperature is detected. FLTB pin is pulled low.

In case of over-current, the device will limit the current pass-through the switch to the value set by RLIM. The switch is turned off if over-current last approximately 1 ms. FLTB pin is pulled low about 500 $\mu$ s after OCP is detected.

### Auto-restart or Latch-off

**AOZ1375DI-01 (auto-restart version):** The device will try to restart 64ms after the power switch is turned off due to fault protection.

**AOZ1375DI-02 (latch-off version):** The device keeps off after fault occurs. It can only be re-enabled by either toggle EN pin or recycle the power.

### Input Capacitor Selection

The input capacitor prevents large voltage transients from appearing at the input, and provides the instantaneous current needed each time the switch turns on to charge output capacitors and to limit input voltage drop. It is also to prevent high-frequency noise on the power line from passing through to the output. The input capacitor should be located as close to the pin as possible. A 10 $\mu$ F ceramic capacitor is recommended. However, higher capacitor values further reduce the transient voltage drop at the input.

### Output Capacitor Selection

The output capacitor has to supply enough current for a large load that it may encounter during system transient. This bulk capacitor must be large enough to supply fast transient load in order to prevent the output from dropping.

There is an upper limit for output capacitor to ensure it can be charged fully during start-up. This upper limit is set by the current limit level and soft-start time.

$$\text{Output Capacitor (Max)} = \text{Current Limit} * \left( t_{ON} / \text{Input Voltage} \right)$$

If output capacitor is too large that output voltage can't reach 75% of the input voltage at the end of soft-start time, short-circuit protection will be triggered.

### Power Dissipation Calculation

Calculate the power dissipation for normal load condition using the following equation:

$$\text{Power Dissipated} = R_{ON} \times ( I_{OUT} )^2$$

The worst case power dissipation occurs when the load current hits the current limit due to over-current or short-circuit fault. The power dissipation under these conditions can be calculated using the following equation:

$$\text{Power Dissipated} = | V_{INT} - V_{BUS} | \times \text{Current Limit}$$

### Layout Guidelines

Good PCB layout is important for improving the thermal and overall performance of AOZ1375DI. To optimize the switch response time to output short-circuit conditions, keep all traces as short as possible to reduce the effect of unwanted parasitic inductance. Place the input and output bypass capacitors as close as possible to the VINT and VBUS pins. The input and output PCB traces should be as wide as possible for the given PCB space. Use a ground plane to enhance the power dissipation capability of the device. For accuracy current limit during source mode operation, RSENSE signal must be Kelvin connection to CSP and CSN pin. The sense location for RSENSE should be as close to the resistor terminal as possible to reduce the effect of resistance from PCB trace. Figure 21 shows the evaluation board reference layout.

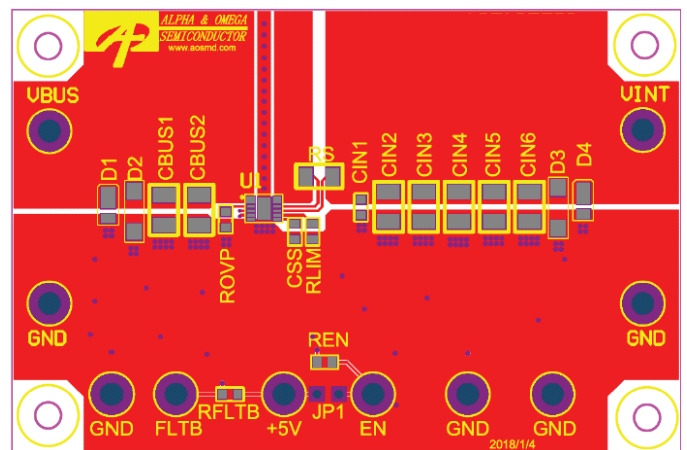
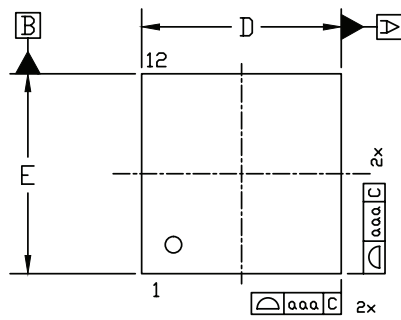
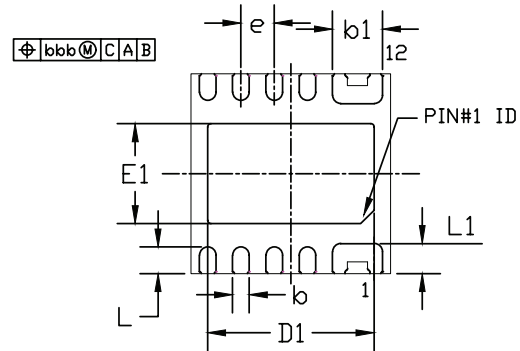

Figure 21. Evaluation Board Layout

Package Dimensions, DFN3x3-12L



TOP VIEW



BOTTOM VIEW

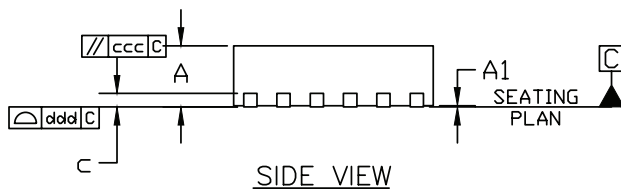

SIDE VIEW

RECOMMENDED LAND PATTERN

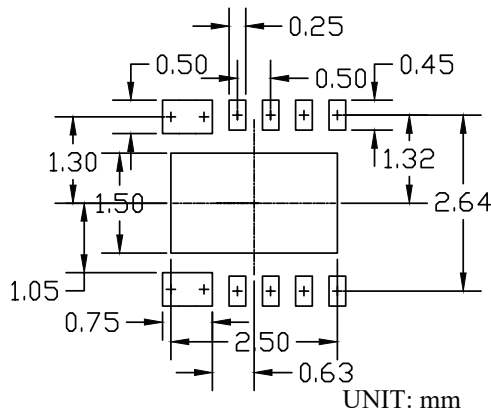

SYMBOLS	DIMENSIONS IN MILLIMETERS			DIMENSIONS IN INCHES		
	MIN	NOM	MAX	MIN	NOM	MAX
A	0.80	0.90	1.00	0.031	0.035	0.039
A1	0.00	0.02	0.05	0.000	0.001	0.002
b	0.20	0.25	0.30	0.008	0.010	0.012
b1	0.70	0.75	0.80	0.028	0.030	0.032
c	0.203BSC			0.008BSC		
D	3.00 BSC			0.118 BSC		
D1	2.40	2.50	2.60	0.094	0.098	0.102
E	3.00 BSC			0.118 BSC		
E1	1.40	1.50	1.60	0.055	0.059	0.063
e	0.50BSC			0.020BSC		
L	0.30	0.40	0.50	0.012	0.016	0.020
L1	0.35	0.45	0.55	0.014	0.018	0.022
aaa	0.15			0.006		
bbb	0.10			0.004		
ccc	0.10			0.004		
ddd	0.08			0.003		

NOTE

1. DIMENSIONING AND TOLERANCING CONFORM TO ASME Y14.5M-1994.
2. CONTROLLING DIMENSION IS MILLIMETER.  
CONVERTED INCH DIMENSIONS ARE NOT NECESSARILY EXACT.
3. DIMENSION b APPLIES TO METALLIZED TERMINAL AND IS MEASURED BETWEEN 0.15mm. AND 0.30mm FROM THE TERMINAL TIP. IF THE TERMINAL HAS THE OPTIONAL RADIUS ON THE OTHER END OF THE TERMINAL, THE DIMENSION b SHOULD NOT BE MEASURED IN THAT RADIUS AREA.
4. COPLANARITY ddd APPLIES TO THE TERMINALS AND ALL OTHER BOTTOM SURFACE METALLIZATION.

### Tape and Reel Dimensions, DFN3x3-12L

#### Carrier Tape

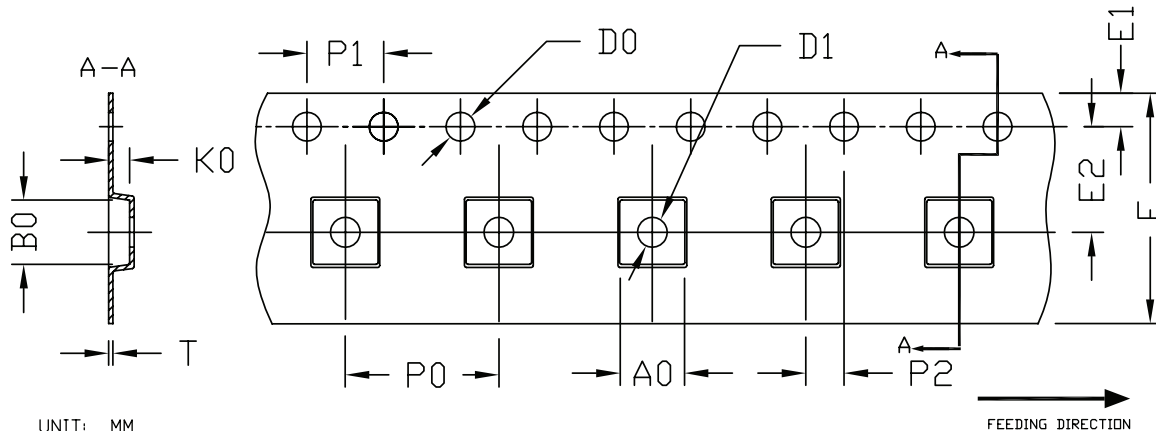

UNIT: MM

PACKAGE	A0	B0	K0	D0	D1	E	E1	E2	P0	P1	P2	T
DFN3x3_EP	3.40 ±0.10	3.35 ±0.10	1.10 ±0.10	1.50 +0.10 -0	1.50 +0.10 -0	12.00 ±0.30	1.75 ±0.10	5.50 ±0.05	8.00 ±0.10	4.00 ±0.10	2.00 ±0.05	0.30 ±0.05

#### Reel

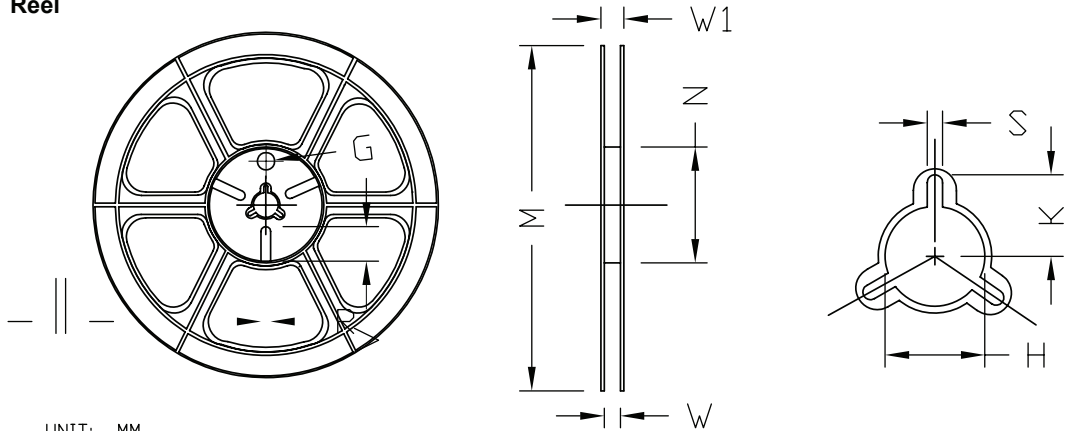

UNIT: MM

TAPE SIZE	REEL SIZE	M	N	W	W1	H	K	S	G	R	V
12 mm	φ330	φ330.00 ±0.50	φ97.00 ±0.10	13.00 ±0.30	17.40 ±1.00	φ13.00 +0.50 -0.20	10.60	2.00 ±0.50	---	---	---

#### DFN3x3 EP TAPE

#### Leader / Trailer & Orientation

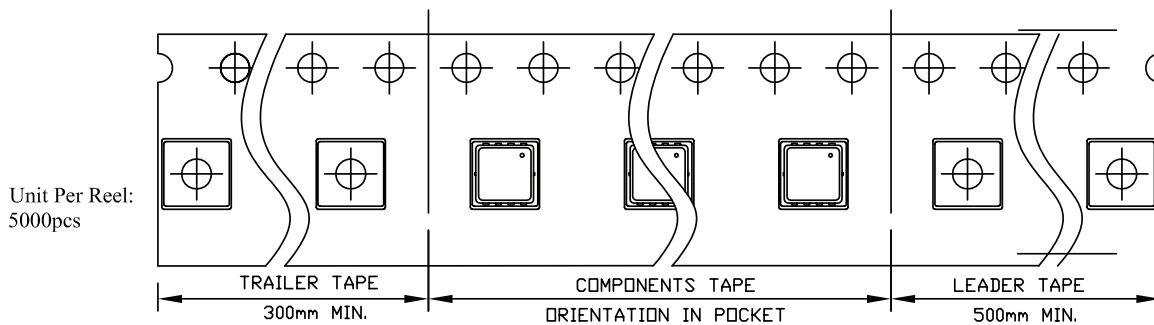

Unit Per Reel:  
5000pcs

## Part Marking

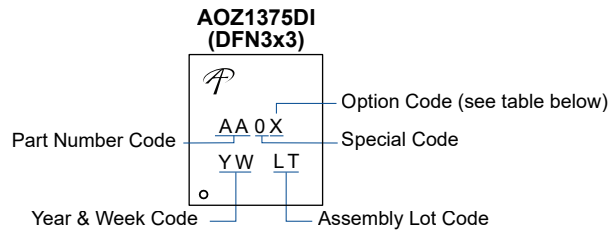

Part Number	Description	Code
AOZ1375DI-01	Green Product	AA01
AOZ1375DI-02	Green Product	AA02

## LEGAL DISCLAIMER

Applications or uses as critical components in life support devices or systems are not authorized. Alpha and Omega Semiconductor does not assume any liability arising out of such applications or uses of its products. AOS reserves the right to make changes to product specifications without notice. It is the responsibility of the customer to evaluate suitability of the product for their intended application. Customer shall comply with applicable legal requirements, including all applicable export control rules, regulations and limitations.

AOS's products are provided subject to AOS's terms and conditions of sale which are set forth at:

[http://www.aosmd.com/terms\\_and\\_conditions\\_of\\_sale](http://www.aosmd.com/terms_and_conditions_of_sale)

## LIFE SUPPORT POLICY

ALPHA AND OMEGA SEMICONDUCTOR PRODUCTS ARE NOT AUTHORIZED FOR USE AS CRITICAL COMPONENTS IN LIFE SUPPORT DEVICES OR SYSTEMS.

As used herein:

1. Life support devices or systems are devices or systems which, (a) are intended for surgical implant into the body or (b) support or sustain life, and (c) whose failure to perform when properly used in accordance with instructions for use provided in the labeling, can be reasonably expected to result in a significant injury of the user.
2. A critical component in any component of a life support, device, or system whose failure to perform can be reasonably expected to cause the failure of the life support device or system, or to affect its safety or effectiveness.

## Looking for pricing, stock, or lifecycle information?

Click below to explore more details on WIN SOURCE:

- ⊖ [View AOZ1375DI-02 on WIN SOURCE](#)
- ⊖ [Alpha & Omega Semiconductor Inc. Information](#)

## Optimize Your Supply Chain with WIN SOURCE Solutions

- ✓ Global Sourcing Solution
- ✓ Obsolete Management
- ✓ Cost Control Management
- ✓ Shortage Management
- ✓ Alternative Solution
- ✓ Excess Inventory Management