



**THE DATASHEET OF  
AP3783RBK6TR-G1**



## Description

The AP3783R is a high frequency, high efficiency and high accuracy switching mode power supply controller to drive power MOSFET for 5V/2A battery charger/adaptor applications. The controller regulates the output voltage and current in the primary side by piece-wise Pulse Frequency Modulation (p-PFM) in discontinuous conduction mode (DCM). The system operating frequency reduces linearly from heavy load to light load in each interval of the p-PFM, and enters constant current mode when the load current equals to the maximum system output current.

The AP3783R provides accurate constant voltage (CV), constant current (CC) and outstanding dynamic performance without requiring an opto-coupler. It also eliminates the need of loop compensation circuitry while maintaining stability.

The AP3783R provides valley turn-on function and 3-Segment drive current to improve the power supply EMI performance. The AP3783R also has built-in fixed cable voltage drop compensation (8%, 4% and 2% of nominal system output voltage to meet various cables with different length and gauge) and adjustable line voltage compensation.

The AP3783R achieves excellent regulation and high average efficiency, less than 2s startup time for 30mW standby power solution. When AP3783R is used with APR3415, good undershoot and efficiency performances can be achieved.

The AP3783R is packaged in SOT26.

## Applications

- Adapters/Chargers
- Standby and Auxiliary Power Supplies

- Notes:
1. No purposely added lead. Fully EU Directive 2002/95/EC (RoHS), 2011/65/EU (RoHS 2) & 2015/863/EU (RoHS 3) compliant.
  2. See <https://www.diodes.com/quality/lead-free/> for more information about Diodes Incorporated's definitions of Halogen- and Antimony-free, "Green" and Lead-free.
  3. Halogen- and Antimony-free "Green" products are defined as those which contain <900ppm bromine, <900ppm chlorine (<1500ppm total Br + Cl) and <1000ppm antimony compounds.

## Pin Assignments

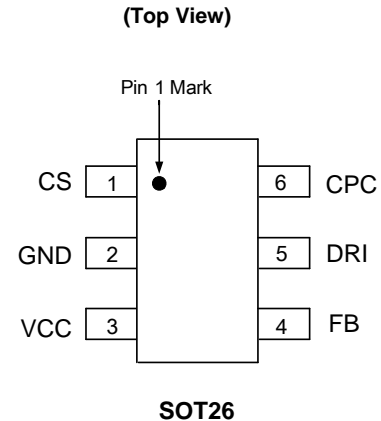

## Features

- Less than 30mW Standby Power Consumption
- Meet Efficiency Requirement of COC Trier2
- Valley Turn-on to Reduce Switching Loss and Improve EMI
- Piece-wise Frequency Reduction to Enhance Conversion Efficiency and Suppress Audio Noise
- Over Voltage Protection (OVP)
- Over Temperature Protection (OTP)
- Short Circuit Protection (SCP) with Hiccup
- 3-Segment Drive Current for Radiative EMI Suppression
- Operating Frequency Jitter Function for Conductive EMI Suppression
- Drive MOSFET for 5W to 20W Battery Charger/Adapter Applications
- SOT26 SMD Package Comply with Level 3 of IPC/JEDEC J-STD-033A
- **Totally Lead-Free & Fully RoHS Compliant (Notes 1 & 2)**
- **Halogen and Antimony Free. "Green" Device (Note 3)**
- **For automotive applications requiring specific change control (i.e. parts qualified to AEC-Q100/101/200, PPAP capable, and manufactured in IATF 16949 certified facilities), please [contact us](mailto:contact@diodes.com) or your local Diodes representative. <https://www.diodes.com/quality/product-definitions/>**





**Absolute Maximum Ratings** (Note 4)

Symbol	Parameter	Rating	Unit
V <sub>CC</sub>	Supply Voltage	-0.3 to 35	V
V <sub>CS</sub> , V <sub>CPC</sub>	Voltage on CS, CPC Pin	-0.3 to 7	V
V <sub>FB</sub>	FB Input Voltage	-0.4 to 10	V
I <sub>SOURCE</sub>	Source Current from OUT Pin	Internally Limited	A
T <sub>J</sub>	Operating Junction Temperature	-40 to +150	°C
T <sub>STG</sub>	Storage Temperature	-65 to +150	°C
T <sub>LEAD</sub>	Lead Temperature (Soldering, 10 sec)	+300	°C
θ <sub>JA</sub>	Thermal Resistance (Junction to Ambient) (Note 5)	200	°C/W
ESD	ESD (Human Body Model)	6000	V
	ESD (Charged Device Model)	400	V

Note: 4. Stresses greater than those listed under *Absolute Maximum Ratings* can cause permanent damage to the device. These are stress ratings only, and functional operation of the device at these or any other conditions beyond those indicated under *Recommended Operating Conditions* is not implied. Exposure to *Absolute Maximum Ratings* for extended periods can affect device reliability.  
5. Test condition: Device mounted on FR-4 substrate PC board, 2oz copper, with 1inch<sup>2</sup> cooling area.

**Recommended Operating Conditions**

Symbol	Parameter	Min	Max	Unit
V <sub>CC</sub>	Supply Voltage	—	25	V
T <sub>OP</sub>	Operating Temperature Range	-40	+105	°C
f <sub>S(MAX)</sub>	Maximum Operating Frequency	—	80	kHz

**Electrical Characteristics** (@V<sub>CC</sub>=15V, T<sub>A</sub>=+25°C, unless otherwise specified.)

Symbol	Parameter	Conditions	Min	Typ	Max	Unit
<b>STARTUP AND UVLO SECTION</b>						
V <sub>TH_ST</sub>	Startup Threshold	—	13	15.5	18	V
V <sub>OPR(MIN)</sub>	Minimal Operating Voltage	—	6	6.8	7.6	V
<b>STANDBY CURRENT SECTION</b>						
I <sub>ST</sub>	Startup Current	V <sub>CC</sub> =V <sub>TH_ST</sub> -1V before startup	0	0.2	0.6	μA
I <sub>CC_OPR</sub>	Operating Current	Static current @ no load	350	500	650	
<b>DRIVING OUTPUT SECTION</b>						
V <sub>GATE</sub>	Gate Voltage	—	10	11	12	V
I <sub>SOURCE_L</sub>	Low Driver Source Current	—	38	43	48	mA
I <sub>SOURCE_H</sub>	High Driver Source Current	—	100	110	120	mA
V <sub>TH</sub>	High/Low Drive Source Current Threshold Voltage	—	6	6.5	7	V
R <sub>SINK</sub>	Sink Resistance	—	5.5	6.5	7.5	Ω
<b>OPERATING FREQUENCY SECTION (LL MODE TO FULL LOAD)</b>						
f <sub>S(MAX)</sub>	Maximum Operating Frequency	I <sub>O(MAX)</sub> (Note 6)	—	—	70	kHz
t <sub>SAMPLE_H</sub>	Sample Time	37% to 100% I <sub>O(MAX)</sub>	3.8	4.2	4.6	μs
t <sub>SAMPLE_L</sub>		0% to 37% I <sub>O(MAX)</sub> (Note 7)	2.15	2.4	2.65	μs

Notes: 6. The output constant-current design value, generally set to 110% to 120% of full load.  
7. Guaranteed by design.

**Electrical Characteristics** (@V<sub>CC</sub>=15V, T<sub>A</sub>=+25°C, unless otherwise specified.) (continued)

Symbol	Parameter	Conditions	Min	Typ	Max	Unit
<b>OPERATING FREQUENCY SECTION (LL MODE)</b>						
V <sub>CPC(EN)</sub>	CPC Pin Voltage to Enter LL Mode	—	18	20	22	mV
V <sub>CPC(EX)</sub>	CPC Pin Voltage to Exit LL Mode	—	36	40	44	mV
t <sub>OFF(EN)</sub>	Off Time to Enter LL Mode	From the end of t <sub>ONS</sub>	230	256	282	μs
t <sub>OFF(EX)</sub>	Off Time to Exit LL Mode	From the end of t <sub>ONS</sub>	230	256	282	μs
<b>FREQUENCY JITTER</b>						
ΔV <sub>CS</sub> /V <sub>CS</sub>	V <sub>CS</sub> Modulation	6.5% to 100% I <sub>O(MAX)</sub>	4.5	5	5.5	%
f <sub>MOD</sub>	V <sub>CS</sub> Modulation Frequency		3.6	4	4.4	kHz
<b>CURRENT SENSE SECTION</b>						
V <sub>CS_H</sub>	Peak Current Sense Threshold Voltage	37% to 100% I <sub>O(MAX)</sub>	828	900	972	mV
V <sub>CS_L</sub>		0% to 37% I <sub>O(MAX)</sub>	460	500	540	mV
R <sub>LINE</sub>	Built-in Line Compensation Resistor	(Note 8)	245	260	275	Ω
t <sub>LEB</sub>	Leading Edge Blanking	(Note 7)	400	500	600	ns
<b>CONSTANT VOLTAGE SECTION</b>						
V <sub>FB</sub>	Feedback Threshold Voltage	Closed loop test of V <sub>OUT</sub>	3.95	4.01	4.07	V
R <sub>FB</sub>	FB Pin Input Resistance	V <sub>FB</sub> =4V	560	700	840	kΩ
V <sub>CABLE</sub> /V <sub>OUT</sub> %	Cable Compensation Ratio	AP3783RA	7	8	9	%
		AP3783RB	3	4	5	%
		AP3783RC	1	2	3	%
<b>CONSTANT CURRENT SECTION</b>						
t <sub>ONS</sub> /t <sub>SW</sub>	Secondary Winding Conduction Duty	V <sub>FB</sub> =4V	0.47	0.5	0.53	—
<b>VALLEY-ON SECTION</b>						
t <sub>VAL-ON</sub>	Valid Off Time of Valley-on	From the end of t <sub>ONS</sub>	14.4	16	17.6	μs
<b>DYNAMIC SECTION</b>						
V <sub>TRIGGER</sub>	Trigger Voltage for Dynamic Function	—	70	85	100	mV
t <sub>DELAY</sub>	Delay Time for Dynamic Function	From the end of t <sub>ONS</sub>	105	135	165	μs
V <sub>UV_H</sub>	Under Voltage of FB Pin for V <sub>CS_H</sub>	—	3.82	3.89	3.96	V
t <sub>OFF(MAX)</sub>	Maximum Off Time	—	6	8	10	ms
<b>PROTECTION FUNCTION SECTION</b>						
V <sub>FB(OVP)</sub>	Over Voltage Protection at FB Pin	—	7.1	7.5	7.9	V
V <sub>CC(OVP)</sub>	Over Voltage Protection at VCC Pin	—	28	31	34	V
t <sub>ONP(MAX)</sub>	Maximum Turn-on Time	—	13	19	25	μs
V <sub>FB(SCP)</sub>	Short Circuit Protection	V <sub>FB</sub> @ Hiccup	2.45	2.6	2.75	V
t <sub>SCP</sub>	Maximum Time under V <sub>FB(SCP)</sub>	—	115	128	141	ms
T <sub>OTP</sub>	Shutdown Temperature	—	+126	+140	+154	°C
T <sub>HYS</sub>	Temperature Hysteresis	—	+36	+40	+44	°C

Notes: 7. Guaranteed by design.

8. Line compensation voltage on CS reference: 
$$\Delta V_{CS\_REF} = 0.438 \times \frac{R_{LINE}}{R_{FB1} + R_{LINE}} \times V_{AUX}$$

**Performance Characteristics**

**Start-up Voltage vs. Ambient Temperature**

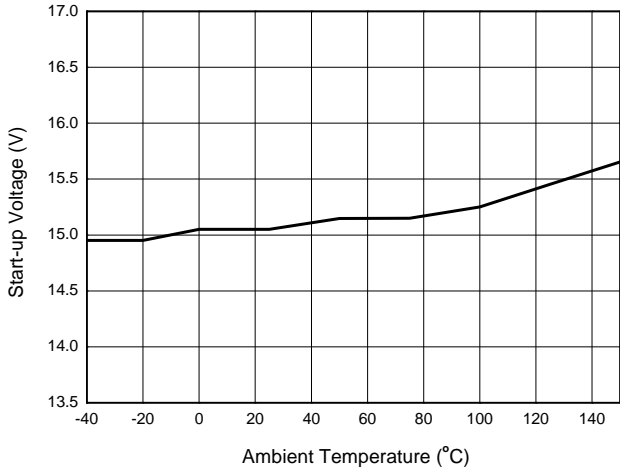

**Start-up Current vs. Ambient Temperature**

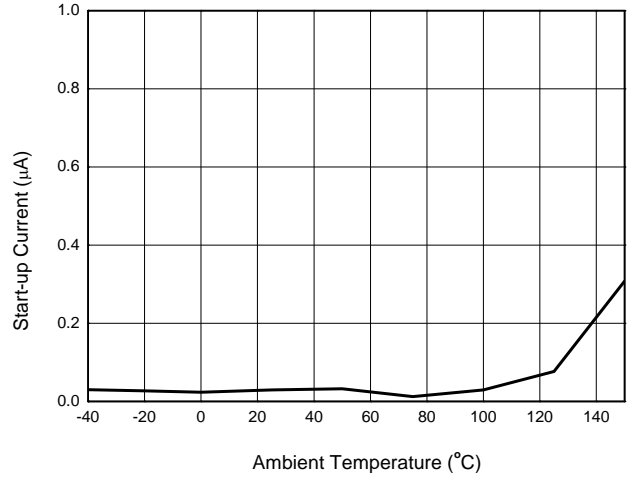

**Minimal Operating Voltage vs. Ambient Temperature**

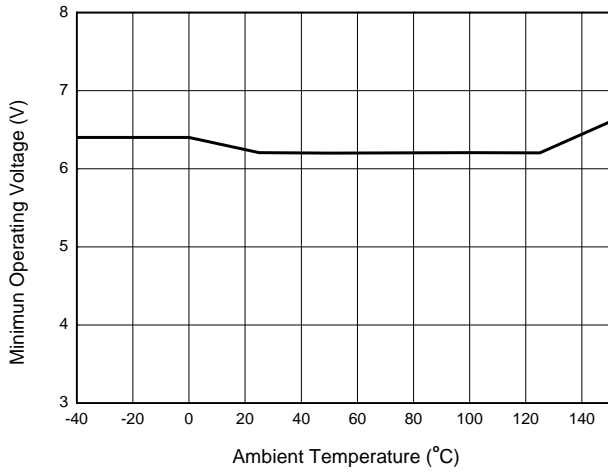

**Operating Current vs. Ambient Temperature**

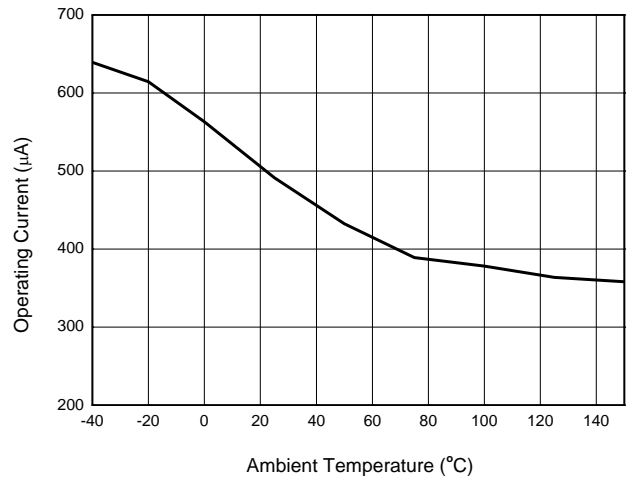

**High Source Current vs. Ambient Temperature**

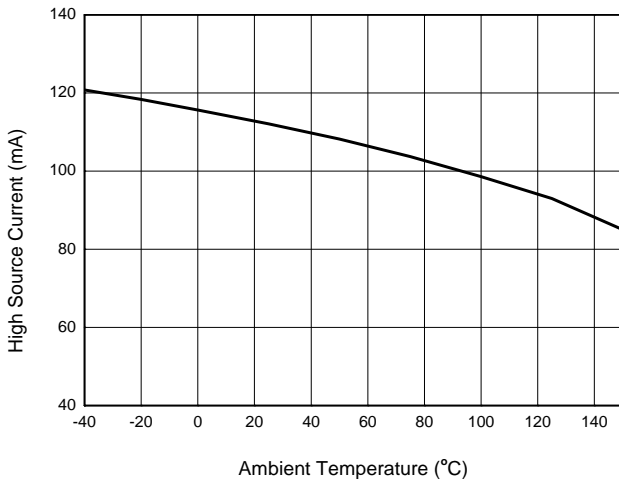

**Sink Resistance vs. Ambient Temperature**

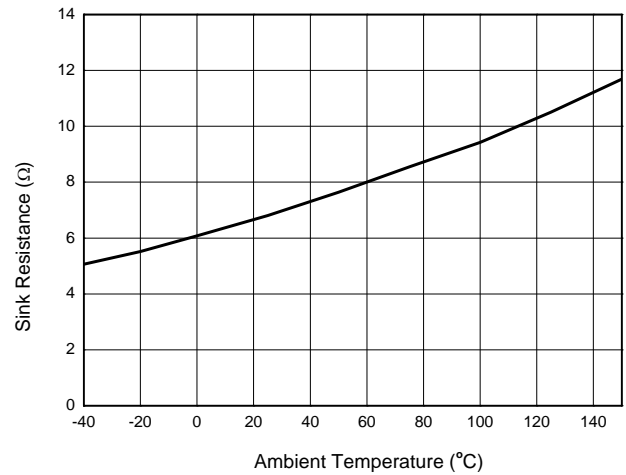

**Performance Characteristics** (continued)

**Feedback Voltage vs. Ambient Temperature**

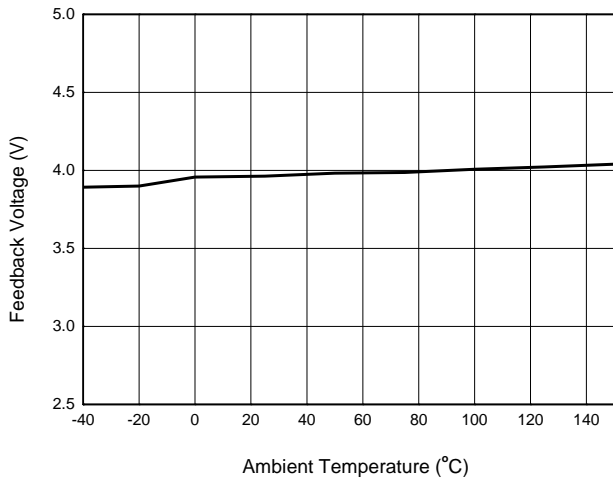

**Gate Voltage vs. Ambient Temperature**

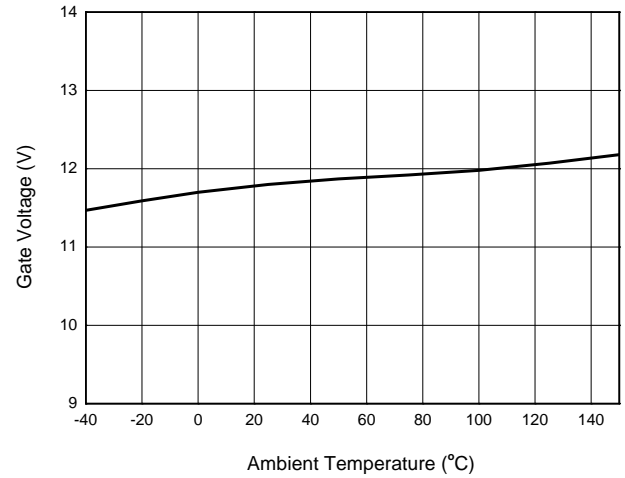

**Line Compensation Resistance vs. Ambient Temperature**

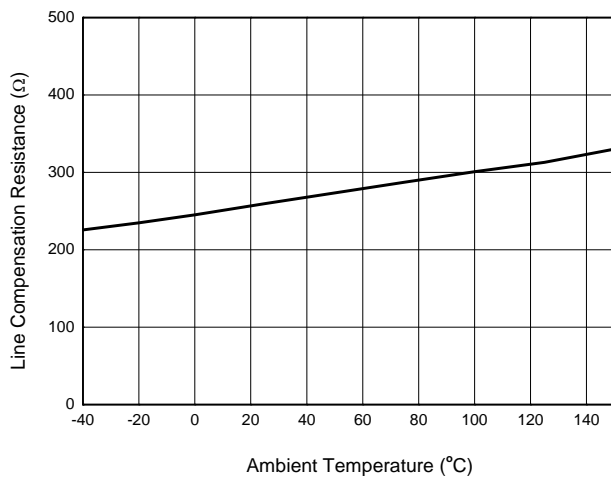

**Input Resistance of FB Pin vs. Ambient Temperature**

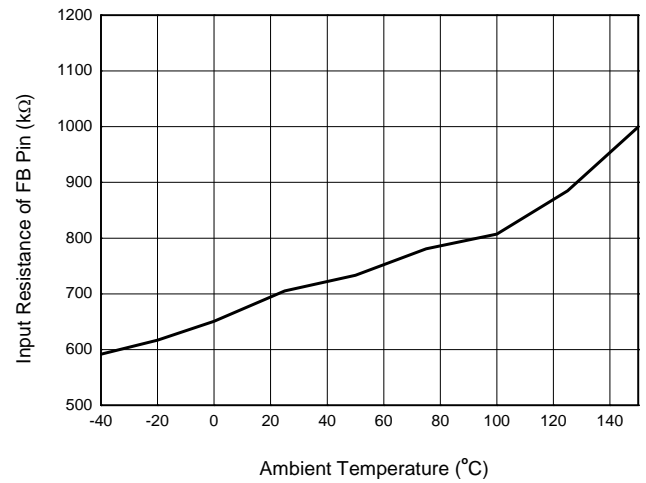



## Operation Principle Description (continued)

Figure 2 shows the typical waveforms which demonstrate the basic operating principle of AP3783R application. And the parameters are defined as following.

$I_P$ ---The primary side current

$I_S$  ---The secondary side current

$I_{PK}$ ---Peak value of primary side current

$I_{PKS}$ ---Peak value of secondary side current

$V_{SEC}$ ---The transient voltage at secondary winding

$V_O$ ---The output voltage

$V_{AUX}$ ---The transient voltage at auxiliary winding

$V_A$ --- The stable voltage at auxiliary winding when rectification diode is in conducting status, which equals the sum of voltage  $V_{CC}$  and the forward voltage drop of auxiliary diode

$t_{SW}$  ---The period of switching frequency

$t_{ONP}$  ---The conduction time when primary side switch is "ON"

$t_{ONS}$  ---The conduction time when secondary side diode is "ON"

$t_{OFF}$  ---The dead time when neither primary side switch nor secondary side diode is "ON"

$t_{OFFS}$  --- The time when secondary side diode is "OFF"

For primary-side regulation, the primary current  $i_p(t)$  is sensed by a current sense resistor  $R_{CS}$  (as shown in Figure 1).The current rises up linearly at a rate of:

$$\frac{di_p(t)}{dt} = \frac{V_{IN}(t)}{L_M} \quad (1)$$

As illustrated in Figure 2, when the current  $i_p(t)$  rises up to  $I_{PK}$ , the switch Q1 turns off. The constant peak current is given by:

$$I_{PK} = \frac{V_{CS}}{R_{CS}} \quad (2)$$

The energy stored in the magnetizing inductance  $L_M$  each cycle is therefore:

$$E_g = \frac{1}{2} \times L_M \cdot I_{PK}^2 \quad (3)$$

So the power transferring from the input to the output is given by:

$$P = \frac{1}{2} \times L_M \times I_{PK}^2 \times f_{SW} \quad (4)$$

Where, the  $f_{SW}$  is the switching frequency. When the peak current  $I_{PK}$  is constant, the output power depends on the switching frequency  $f_{SW}$ .

### Constant Voltage Operation

As for constant-voltage (CV) operation mode, the AP3783R detects the auxiliary winding voltage at FB pin to regulate the output voltage. The auxiliary winding voltage is coupled with secondary side winding voltage, so the auxiliary winding voltage at  $t_{ONS}$  is:

$$V_{AUX} = \frac{N_{AUX}}{N_S} \times (V_O + V_d) \quad (5)$$

Where  $V_d$  is the conduction voltage drop of MOSFET in APR3415.

**Operation Principle Description** (continued)

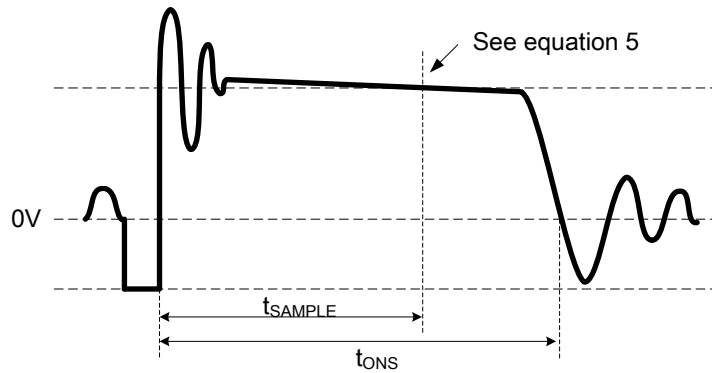

Figure 3. Auxiliary Voltage Waveform

The voltage detection point is at a constant delay time of  $t_{ONS}$ . The constant delay time is changed with the different primary peak current. The CV loop control function of AP3783R then generates a  $t_{OFF}$  to regulate the output voltage.

**Constant Current Operation**

The AP3783R can work in constant-current (CC) mode. Figure 2 shows the secondary current waveforms.

In CC operation mode, the CC control loop of AP3783R will keep a fixed proportion between  $t_{ONS}$  and  $t_{OFFS}$ . The fixed proportion is

$$\frac{t_{ONS}}{t_{OFFS}} = \frac{4}{4} \quad (6)$$

The relationship between the output constant-current and secondary peak current  $I_{PKS}$  is given by:

$$I_{O(MAX)} = \frac{1}{2} \times I_{PKS} \times \frac{t_{ONS}}{t_{ONS} + t_{OFFS}} \quad (7)$$

As for tight coupled primary and secondary winding, the secondary peak current is

$$I_{PKS} = \frac{N_P}{N_S} \times I_{PK} \quad (8)$$

Thus the output constant-current is given by:

$$I_{O(MAX)} = \frac{1}{2} \times \frac{N_P}{N_S} \times I_{PK} \times \frac{t_{ONS}}{t_{ONS} + t_{OFFS}} = \frac{2}{8} \times \frac{N_P}{N_S} \times I_{PK} \quad (9)$$

Therefore, the AP3783R can realize CC mode operation by constant primary peak current and fixed diode conduction duty cycle.

**Multiple Segment Constant Peak Current**

As for the original PFM PSR system, the switching frequency decreases with output current decreasing, which will encounter audible noise issue since switching frequency decreases to audio frequency range, about less than 20kHz.

In order to avoid audible noise issue, the AP3783R uses 2-segment constant primary peak current control method. At constant voltage mode, the current sense threshold voltage is of multiple segments with different loading, as shown in Figure 4, which are  $V_{CS\_H}$  for high load,  $V_{CS\_L}$  for light load and LL Mode. At constant current mode, the current sense threshold voltage is always  $V_{CS\_H}$ .

**Operation Principle Description** (continued)

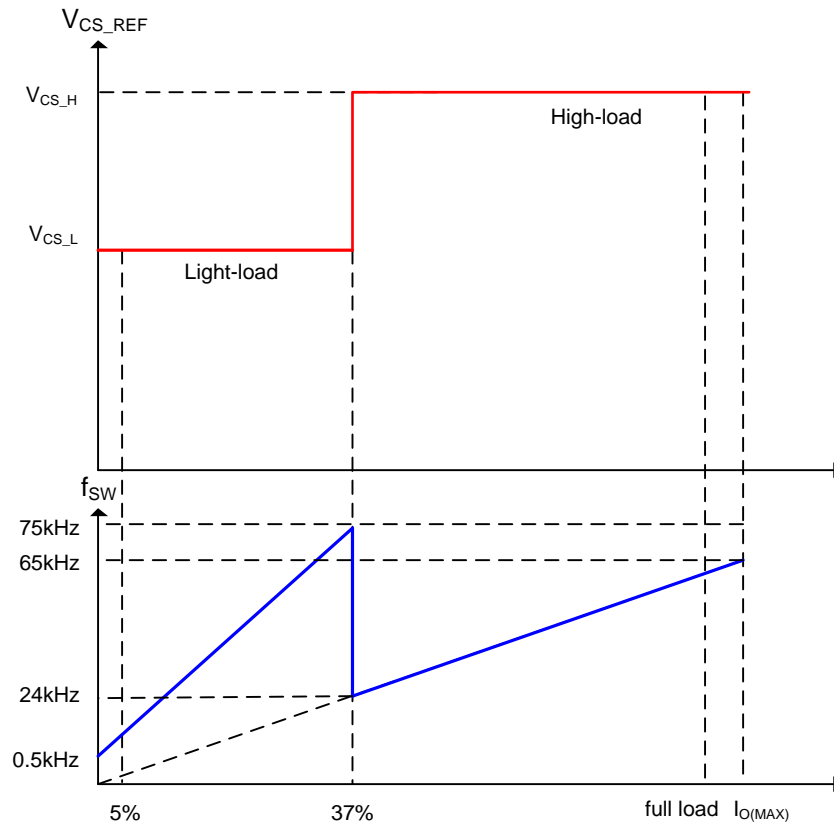

Figure 4. Multiple Segment Peak Current at CV Mode

As Figure 4 shows, with multiple segment peak current control, the AP3783R power system can keep switching frequency above 24kHz at whole heavy load and most of light load to guarantee the audible noise free performance.

**Constant Voltage Operation in LL Mode and Dynamic Response**

In primary side regulation of AP3783R application, the APR3415 must be used at secondary side as the output voltage regulator, low standby power and excellent dynamic response can be achieved. When the output voltage detected by APR3415 is lower than its trigger voltage, the APR3415 outputs periodical signals which will be coupled to auxiliary side. When AP3783R detects the signal which is valid that the signal voltage is higher than  $V_{TRIGGER}$  and  $t_{OFF}$  is longer than  $t_{DELAY}$ , the AP3783R will begin an operating pulse, then primary switch immediately turns on to provide one energy pulse to output terminal and primary  $V_{CC}$ .

By fast response and cooperation, the APR3415 and the AP3783R can maintain a constant output voltage with very low operating frequency in LL mode and also can effectively improve dynamic performance for primary side regulation power system.

The conditions of entering LL mode--- $V_{CPC} < 20mV$  and  $t_{OFF} > 256\mu s$ .

The condition of exiting LL mode--- $V_{CPC} \geq 40mV$  or  $t_{OFF} < 256\mu s$ .

The critical point of the LL mode is generally about 5%  $I_{O(MAX)}$ .

**3-Segment Drive Current for Radiative EMI Suppression**

When the power switch is turned on, a turn-on spike will occur, that worsens the radiative EMI. It is an effective way to decrease drive current before gate voltage gets to miller platform. The AP3783R uses 3-segment drive current for radiative EMI suppression, as shown in Figure 5. When gate voltage gets to 6V, the AP3783R drive current switches from low current (43mA) to high current (110mA). When the gate voltage gets to 10V, the drive current will decrease gradually to 0mA until the gate voltage goes up to the clamp voltage (11V).

**Operation Principle Description** (continued)

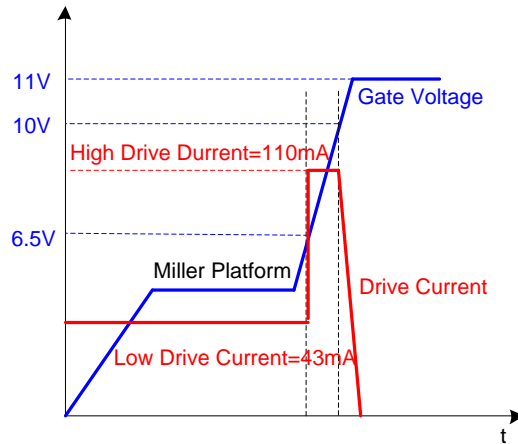

Figure 5. Drive Current and Gate Voltage

**Leading Edge Blanking (LEB) Time**

When the power switch is turned on, a turn-on spike will occur on the sense-resistor. To avoid false turn off switch, a leading-edge blanking is built in. During this blanking time, the current sense comparator is disabled and the external power switch cannot be turned off.

**Adjustable Line Compensation and Fixed Cable Compensation**

The AP3783R power system can adjust line compensation by changing the upper resistor at FB pin. The line compensation capability is increased by decreasing the resistance of the upper FB resistor.

Cable compensation is fixed in AP3783R.

**Valley Turn-on**

When the off time ( $t_{OFF}$ ) is lower than  $16\mu s$ , the AP3783R power system can work with valley turn-on. It can reduce MOSFET switching on power losses which is resulted from the equivalent output capacitance. At the same time, because of valley turn-on the switching frequency has the random jitter feature, which will be benefit for conductive EMI performance. And valley turn-on can also reduce the power switch turn on spike current and then result in the better radiative EMI performance.

**Frequency Jitter**

Even though the valley turn-on function can lead the random frequency jitter feature, an active frequency jitter function is added to AP3783R to ensure the frequency jitter performance in the whole loading condition. By adjusting the  $V_{CS\_REF}$  with deviation of 5.0% every  $256\mu s$  cycle, the active frequency jitter can be realized.

**Short Circuit Protection (SCP)**

Short Circuit Protection (SCP) detection principle is similar to the normal output voltage feedback detection by sensing FB pin voltage. When the detected FB pin voltage is below  $V_{FB(SCP)}$  for a duration of about 128ms, the SCP is triggered. Then the AP3783R enters hiccup mode that the IC immediately shuts down and then restarts, so that the VCC voltage changes between  $V_{TH\_ST}$  and UVLO threshold until  $V_{FB(SCP)}$  condition is removed.

As for the normal system startup, the time duration of FB pin voltage below  $V_{FB(SCP)}$  should be less than  $t_{SCP}$  to avoid entering SCP mode. But for the output short condition or the output voltage below a certain level, the SCP mode will be triggered.

**Operation Principle Description** (continued)

Figure 6 is the AP3783R normal start-up waveform that the voltage of FB pin is above  $V_{FB(SCP)}$  during  $t_{SCP}$  after  $V_{CC}$  gets to the  $V_{TH\_ST}$ , which doesn't enter the SCP mode. As shown in Figure 7,  $V_{OUT}$  is short and the voltage of FB pin is lower than  $V_{FB(SCP)}$  during  $t_{SCP}$ , the AP3783R triggers the SCP and enters the hiccup mode.

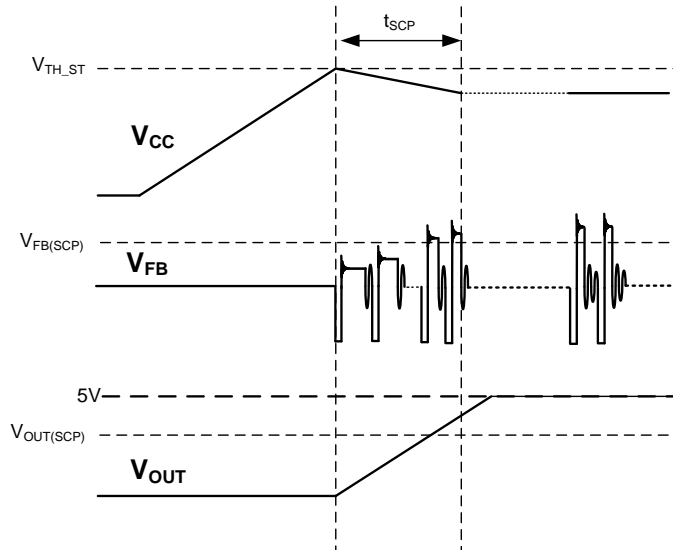

Figure 6. Normal Start-up

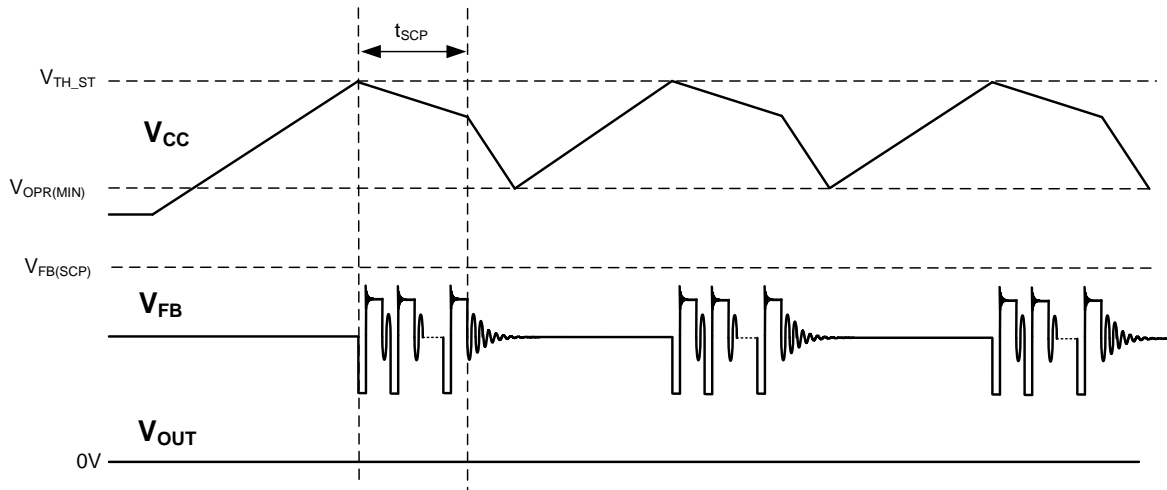

Figure 7. Short Circuit Protection (SCP) and Hiccup Mode

**OVP**

The AP3783R includes output over-voltage protection (OVP). If the voltage at FB pin exceeds  $V_{FB(OVP)}$ , the AP3783R immediately shuts down and keeps the internal circuitry enabled to discharge the VCC capacitor to the UVLO turn-off threshold. After that, the device returns to the start state and a start-up sequence ensues.

**OTP**

If the junction temperature reaches the threshold of +140°C, the AP3783R shuts down immediately. Before VCC voltage decreases to UVLO, if the junction temperature decreases to +100°C, AP3783R can recover to normal operation. If not, the power system enters restart Hiccup mode until the junction temperature decreases below +100°C.

**Ordering Information**

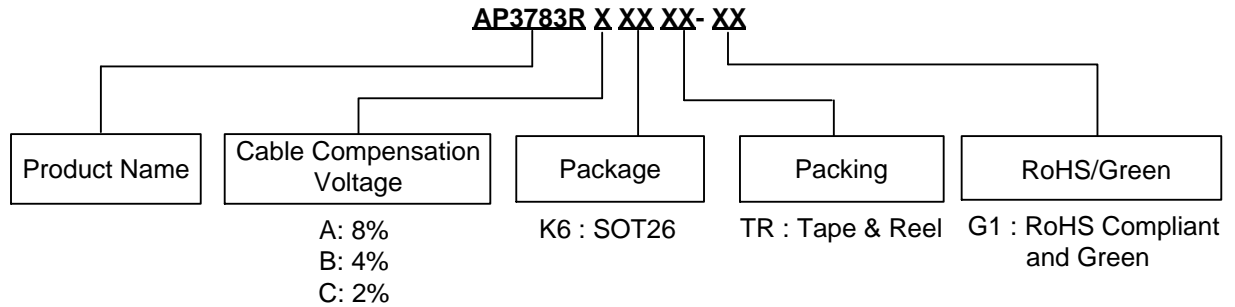

Product	Package	Temperature Range	Cable Compensation Voltage	Part Number	Marking ID	Packing
AP3783R	SOT26	-40 to +85°C	8%	AP3783RAK6TR-G1	GNT	3000/Tape & Reel
			4%	AP3783RBK6TR-G1	GNW	3000/Tape & Reel
			2%	AP3783RCK6TR-G1	GPT	3000/Tape & Reel

**Marking Information**

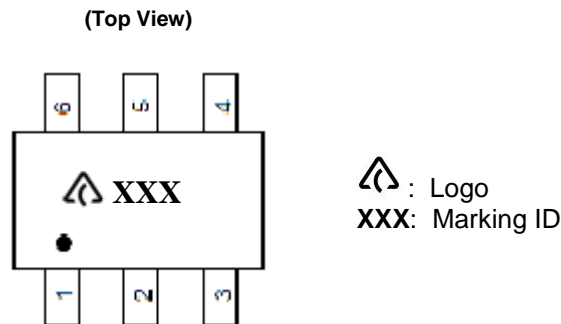

**Package Outline Dimensions** (All dimensions in mm(inch).)

Please see <http://www.diodes.com/package-outlines.html> for the latest version.

(1) Package Type: SOT26

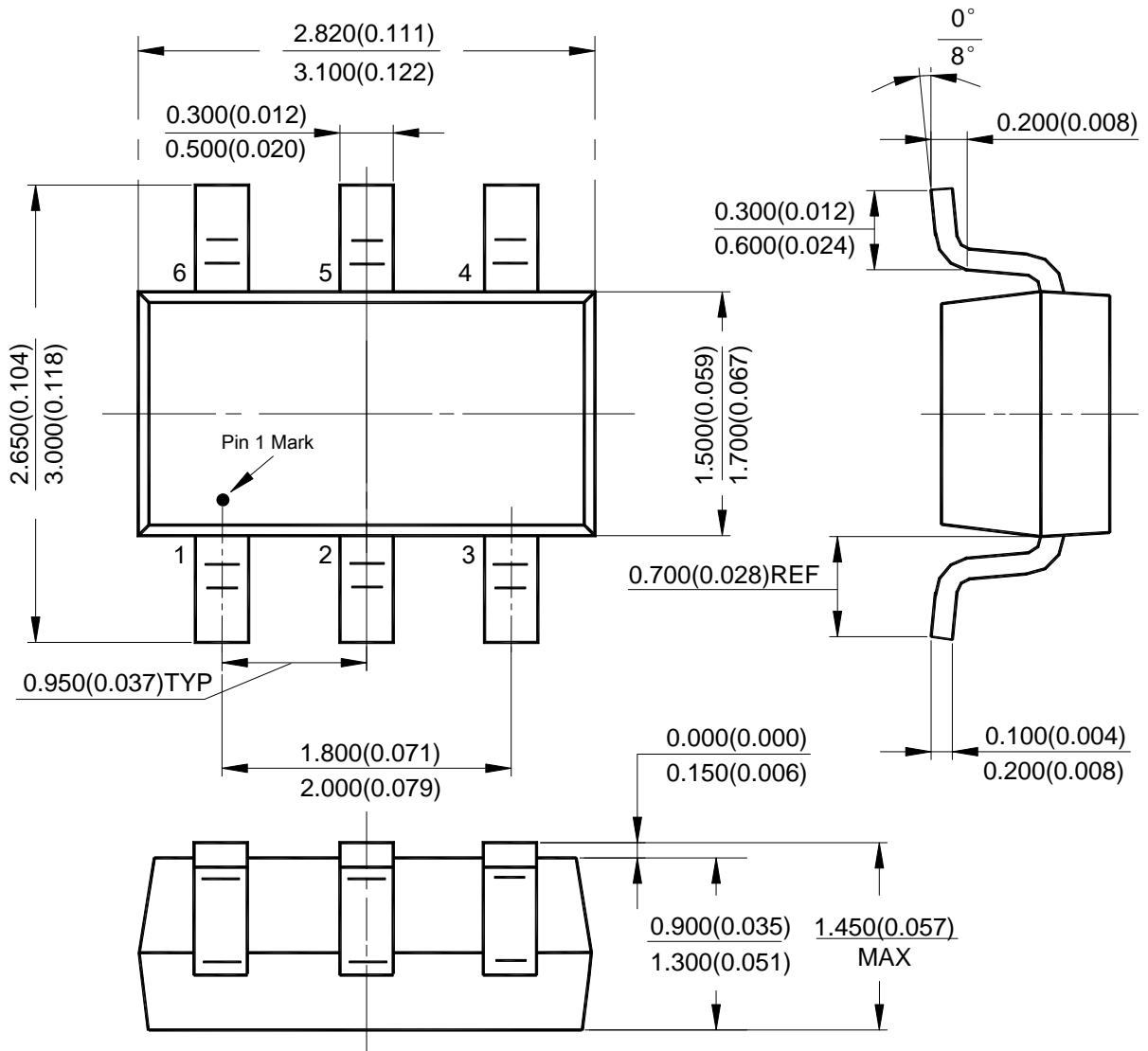

**Suggested Pad Layout**

Please see <http://www.diodes.com/package-outlines.html> for the latest version.

(1) Package Type: SOT26

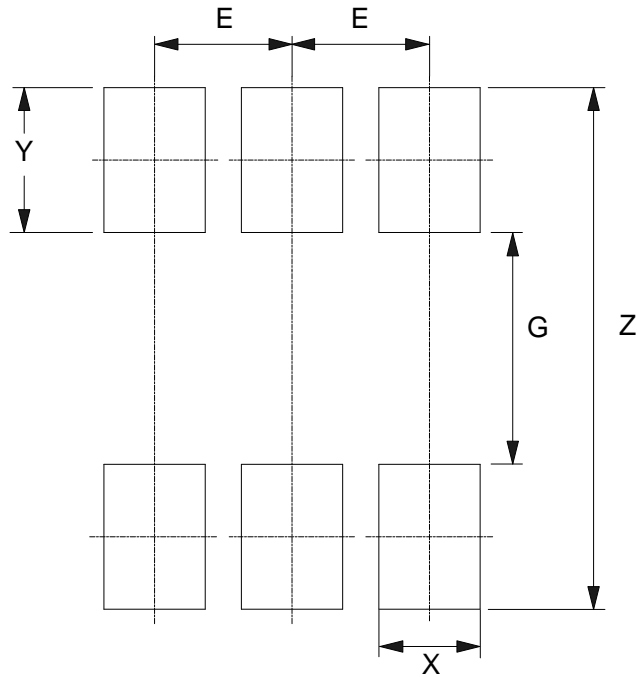

Dimensions	Z (mm)/(inch)	G (mm)/(inch)	X (mm)/(inch)	Y (mm)/(inch)	E (mm)/(inch)
Value	3.600/0.142	1.600/0.063	0.700/0.028	1.000/0.039	0.950/0.037

**IMPORTANT NOTICE**

DIODES INCORPORATED MAKES NO WARRANTY OF ANY KIND, EXPRESS OR IMPLIED, WITH REGARDS TO THIS DOCUMENT, INCLUDING, BUT NOT LIMITED TO, THE IMPLIED WARRANTIES OF MERCHANTABILITY AND FITNESS FOR A PARTICULAR PURPOSE (AND THEIR EQUIVALENTS UNDER THE LAWS OF ANY JURISDICTION).

Diodes Incorporated and its subsidiaries reserve the right to make modifications, enhancements, improvements, corrections or other changes without further notice to this document and any product described herein. Diodes Incorporated does not assume any liability arising out of the application or use of this document or any product described herein; neither does Diodes Incorporated convey any license under its patent or trademark rights, nor the rights of others. Any Customer or user of this document or products described herein in such applications shall assume all risks of such use and will agree to hold Diodes Incorporated and all the companies whose products are represented on Diodes Incorporated website, harmless against all damages.

Diodes Incorporated does not warrant or accept any liability whatsoever in respect of any products purchased through unauthorized sales channel. Should Customers purchase or use Diodes Incorporated products for any unintended or unauthorized application, Customers shall indemnify and hold Diodes Incorporated and its representatives harmless against all claims, damages, expenses, and attorney fees arising out of, directly or indirectly, any claim of personal injury or death associated with such unintended or unauthorized application.

Products described herein may be covered by one or more United States, international or foreign patents pending. Product names and markings noted herein may also be covered by one or more United States, international or foreign trademarks.

This document is written in English but may be translated into multiple languages for reference. Only the English version of this document is the final and determinative format released by Diodes Incorporated.

**LIFE SUPPORT**

Diodes Incorporated products are specifically not authorized for use as critical components in life support devices or systems without the express written approval of the Chief Executive Officer of Diodes Incorporated. As used herein:

A. Life support devices or systems are devices or systems which:

1. are intended to implant into the body, or
2. support or sustain life and whose failure to perform when properly used in accordance with instructions for use provided in the labeling can be reasonably expected to result in significant injury to the user.

B. A critical component is any component in a life support device or system whose failure to perform can be reasonably expected to cause the failure of the life support device or to affect its safety or effectiveness.

Customers represent that they have all necessary expertise in the safety and regulatory ramifications of their life support devices or systems, and acknowledge and agree that they are solely responsible for all legal, regulatory and safety-related requirements concerning their products and any use of Diodes Incorporated products in such safety-critical, life support devices or systems, notwithstanding any devices- or systems-related information or support that may be provided by Diodes Incorporated. Further, Customers must fully indemnify Diodes Incorporated and its representatives against any damages arising out of the use of Diodes Incorporated products in such safety-critical, life support devices or systems.

Copyright © 2019, Diodes Incorporated

[www.diodes.com](http://www.diodes.com)

## Looking for pricing, stock, or lifecycle information?

Click below to explore more details on WIN SOURCE:

 [View AP3783RBK6TR-G1 on WIN SOURCE](#)

 [Diodes Incorporated Information](#)

## Optimize Your Supply Chain with WIN SOURCE Solutions

-  Global Sourcing Solution
-  Obsolete Management
-  Cost Control Management
-  Shortage Management
-  Alternative Solution
-  Excess Inventory Management