



**THE DATASHEET OF
AP7315D-28W5-7**



Description

The AP7315 is a low dropout regulator with high output voltage accuracy, low $R_{DS(ON)}$, high PSRR, low output noise, and low quiescent current. This regulator is based on a CMOS process.

The AP7315 includes a voltage reference, error amplifier, current limit circuit, and an enable input to turn it on and off. With the integrated resistor network fixed output voltage versions can be delivered.

With its low power consumption and line and load transient response, the AP7315 is well suited for low power handheld communication equipment.

The AP7315 is packaged in X2-DFN1010-4, SOT23, and SOT25 packages and allows for the smallest footprint and a dense PCB layout.

Features

- Low V_{IN} and Wide V_{IN} Range: 1.7V to 5.25V
- Guarantee Output Current, 150mA
- V_{OUT} Accuracy $\pm 1\%$
- Ripple Rejection 75dB at 1kHz
- Low Output Noise, 60 μ Vrms from 10Hz to 100kHz
- Quiescent Current as Low as 35 μ A
- V_{OUT} Fixed 1.1V to 3.3V
- **Totally Lead-Free & Fully RoHS Compliant (Notes 1 & 2)**
- **Halogen and Antimony Free, Green Device (Note 3)**
- **For automotive applications requiring specific change control (i.e. parts qualified to AEC-Q100/101/200, PPAP capable, and manufactured in IATF 16949 certified facilities), please [contact us](mailto:contact@diodes.com) or your local Diodes representative. <https://www.diodes.com/quality/product-definitions/>**

Applications

- Smart Phone/PAD
- RF Supply
- Cameras
- Portable Videos
- Portable Media Players
- Wireless Adapters
- Wireless Communication

Notes: 1. No purposely added lead. Fully EU Directive 2002/95/EC (RoHS), 2011/65/EU (RoHS 2) & 2015/863/EU (RoHS 3) compliant.
 2. See <https://www.diodes.com/quality/lead-free/> for more information about Diodes Incorporated's definitions of Halogen- and Antimony-free, "Green" and Lead-free.
 3. Halogen- and Antimony-free "Green" products are defined as those which contain <900ppm bromine, <900ppm chlorine (<1500ppm total Br + Cl) and <1000ppm antimony compounds.

Pin Assignments

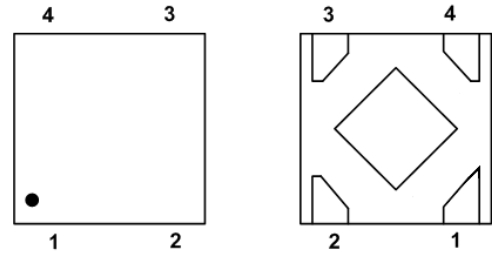

Top View X2-DFN1010-4 Bottom View

Pin 1 – V_{OUT} , Pin 2 – GND, Pin 3 – EN, Pin 4 – V_{IN}

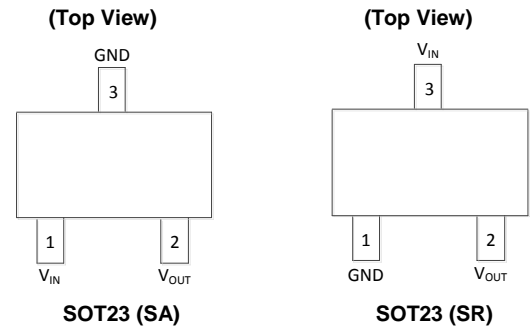

SOT23 (SA)

SOT23 (SR)

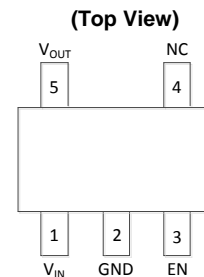

SOT25

Typical Applications Circuit

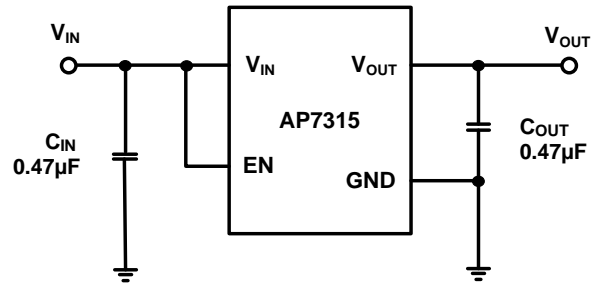

Pin Descriptions

Pin Name	Pin Number				Function
	X2-DFN1010-4	SOT25	SOT23 (SA)	SOT23 (SR)	
V _{OUT}	1	5	2	2	Power output pin
GND	2	2	3	1	Ground
EN	3	3	—	—	Enable Pin This pin should be driven either high or low and must not be floating. Driving this pin high enables the regulator, while pulling it low puts the regulator into shutdown mode
V _{IN}	4	1	1	3	Power input pin
—	Thermal PAD	—	—	—	In PCB layout, prefer to use large copper area to cover this pad for better thermal dissipation, then connect this area to GND or leave it open. However, do not use it as GND electrode function alone.
NC	—	4	—	—	Not Connected internally. Recommend connection to GND to maximize PCB copper for thermal dissipation.

Functional Block Diagram

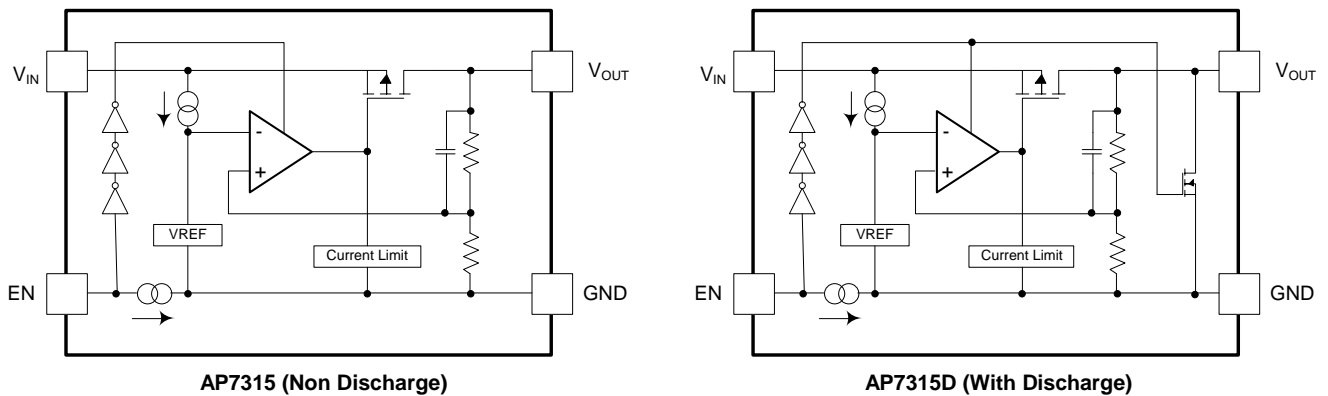

Absolute Maximum Ratings (Note 4) (@ $T_A = +25^\circ\text{C}$, unless otherwise specified.)

Symbol	Parameter	Ratings	Unit
V_{IN}	Input Voltage	6.0	V
V_{EN}	Input Voltage EN	6.0	V
V_{OUT}	Output Voltage	-0.3 to $V_{IN} + 0.3$	V
I_{OUT}	Output Current	300	mA
P_D	Power Dissipation	400	mW
T_A	Operating Ambient Temperature	-40 to +85	$^\circ\text{C}$
T_{STG}	Storage Temperature	-55 to +125	$^\circ\text{C}$

- Note:
4. a). Stresses beyond those listed under Absolute Maximum Ratings may cause permanent damage to the device. These are stress ratings only and functional operation of the device at these conditions is not implied. Exposure to absolute-maximum-rated conditions for extended periods may affect device reliability.
 - b). Ratings apply to ambient temperature at $+25^\circ\text{C}$. The JEDEC High-K board design used to derive this data is a 2in. x 2in. multi-layer board with 1oz. internal power and ground planes and 2oz. copper traces on the top and bottom of the board.

Recommended Operating Conditions (@ $T_A = +25^\circ\text{C}$, unless otherwise specified.)

Symbol	Parameter	Min	Max	Unit
V_{IN}	Input Voltage	1.7	5.25	V
I_{OUT}	Output Current	0	150	mA
T_A	Operating Ambient Temperature	-40	+85	$^\circ\text{C}$

Electrical Characteristics ($V_{EN} = V_{IN} = V_{OUT} + 1.0V$, $C_{IN} = C_{OUT} = 0.47\mu F$, $I_{OUT} = 1.0mA$ @ $T_A = +25^\circ C$, unless otherwise specified.)

Parameter	Conditions	Min	Typ	Max	Units		
Input Voltage	$T_A = -40^\circ C$ to $+85^\circ C$	1.7	—	5.25	V		
Output Voltage Accuracy (Note 11)	$V_{OUT} \geq 2.0V$, $V_{IN} = V_{OUT} + 1V$, $T_A = +25^\circ C$	$V_{OUT} * 0.99$	V_{OUT}	$V_{OUT} * 1.01$	V		
	$V_{OUT} < 2.0V$, $V_{IN} = V_{OUT} + 1V$, $T_A = +25^\circ C$	$V_{OUT} - 20mV$	V_{OUT}	$V_{OUT} + 20mV$	V		
Line Regulation ($dV_{OUT}/dV_{IN}/V_{OUT}$)	$V_{IN} = (V_{OUT} - Nom + 1.0V)$ to $5.25V$, $I_{OUT} = 1.0mA$	—	0.02	0.1	%/V		
Load Regulation ($dV_{OUT}/V_{OUT}/dI_{OUT}$)	$V_{IN} = V_{OUT} - Nom + 1.0V$, $I_{OUT} = 1mA$ to $150mA$	—	0.5	1.0	%/A		
Quiescent Current (Note 6)	$I_{OUT} = 0mA$	20	35	60	μA		
	$I_{OUT} = 150mA$	30	60	100			
$I_{STANDBY}$	$V_{EN} = 0V$ (Disabled)	—	0.01	1.0	μA		
Output Current	—	150	—	—	mA		
Fold-back Short Current (Note 7)	V_{OUT} Short to Ground	—	55	—	mA		
PSRR (Note 8)	$V_{IN} = (V_{OUT} + 1V)V_{DC} + 0.2V_{p-pAC}$, $V_{OUT} \geq 1.8V$, $I_{OUT} = 30mA$		$f = 1kHz$	—	75	—	dB
Output Noise Voltage (Notes 8, 9)	$BW = 10Hz$ to $100kHz$, $I_{OUT} = 30mA$	—	60	—	μV_{rms}		
Dropout Voltage (Note 5)	$I_{OUT} = 150mA$	$1.1V \leq V_{OUT} < 1.5V$	—	0.50	0.64	V	
		$1.5V \leq V_{OUT} < 1.7V$	—	0.38	0.49		
		$1.7V \leq V_{OUT} < 2.0V$	—	0.34	0.44		
		$2.0V \leq V_{OUT} < 2.5V$	—	0.28	0.38		
		$2.5V \leq V_{OUT} < 2.8V$	—	0.22	0.32		
		$2.8V \leq V_{OUT} \leq 3.3V$	—	0.21	0.29		
Output Voltage Temperature Coefficient	$I_{OUT} = 30mA$, $T_A = -40^\circ C$ to $+85^\circ C$	—	± 30	—	ppm/ $^\circ C$		
EN Input Low Voltage	—	0	—	0.5	V		
EN Input High Voltage	—	1.3	—	5.25	V		
EN Input Leakage	$V_{EN} = 0$, $V_{IN} = 5.0V$ or $V_{EN} = 5.0V$, $V_{IN} = 0V$	-1.0	—	+1.0	μA		
On Resistance of N-channel for Auto-Discharge (Note 10)	$V_{IN} = 4.0V$ $V_{EN} = 0V$ (Disabled)	—	30	—	Ω		

- Notes:
- Dropout voltage is the voltage difference between the input and the output at which the output voltage drops 2% below its nominal value.
 - Quiescent current is defined here is the difference in current between the input and the output.
 - Short circuit current is measured with V_{OUT} pulled to GND.
 - This specification is guaranteed by design.
 - To make sure lowest environment noise minimizes the influence on noise measurement.
 - AP7315 has 2 options for output, built-in discharge and non-discharge.
 - Potential multiple grades based on following output voltage accuracy.

Typical Characteristics

Output Voltage vs. Output Current
AP7315-18

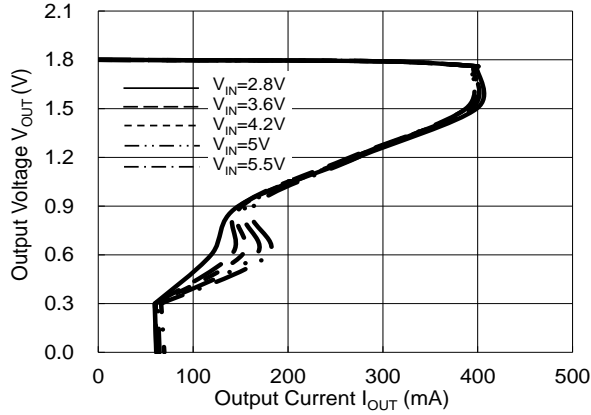

Output Voltage vs. Output Current
AP7315-25

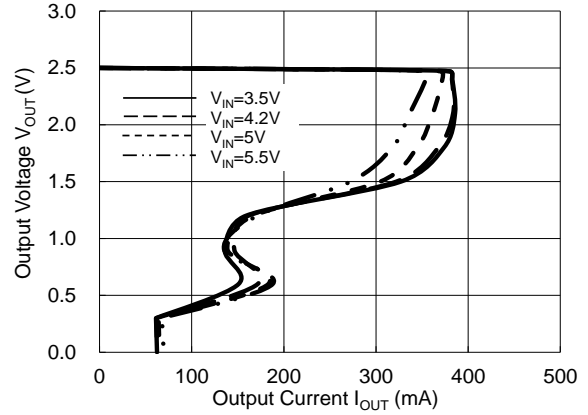

Output Voltage vs. Output Current
AP7315-33

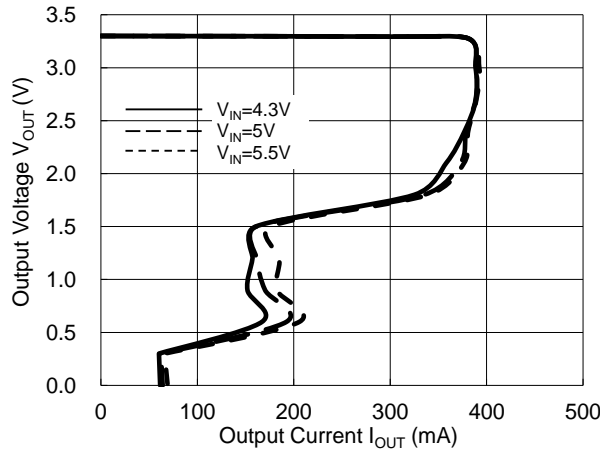

Output Noise (AP7315-33)

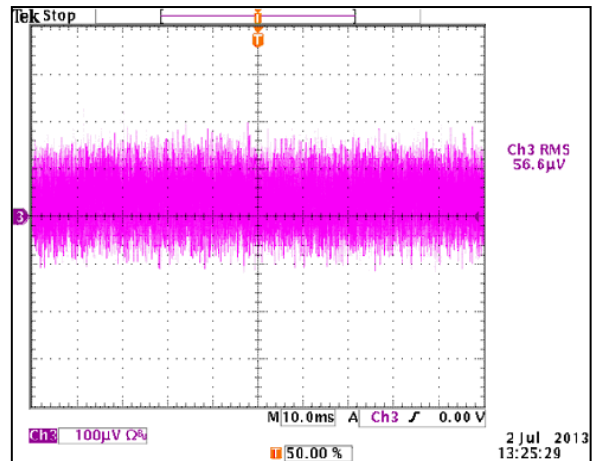

Output Voltage vs. Input Voltage
AP7315-25

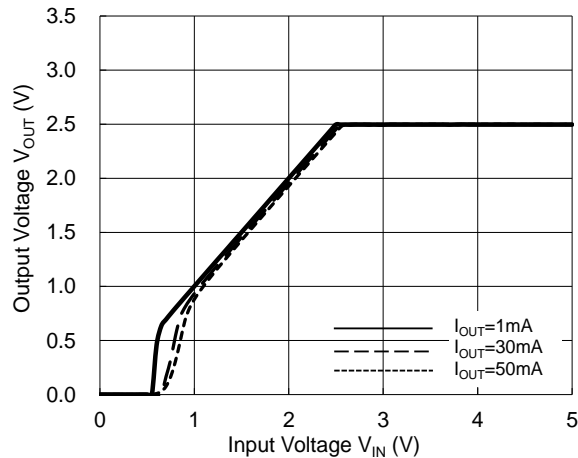

Output Voltage vs. Input Voltage
AP7315-33

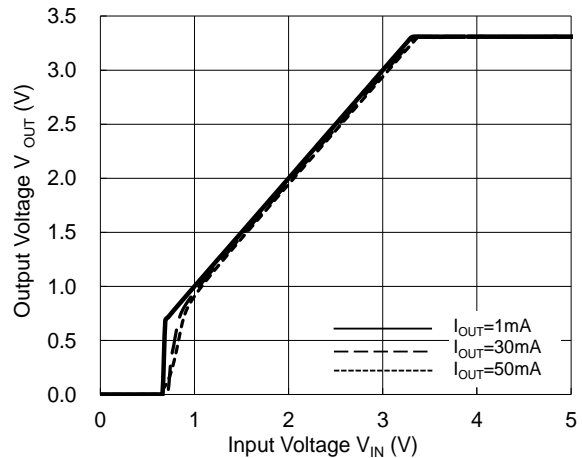

Typical Characteristics (Continued)

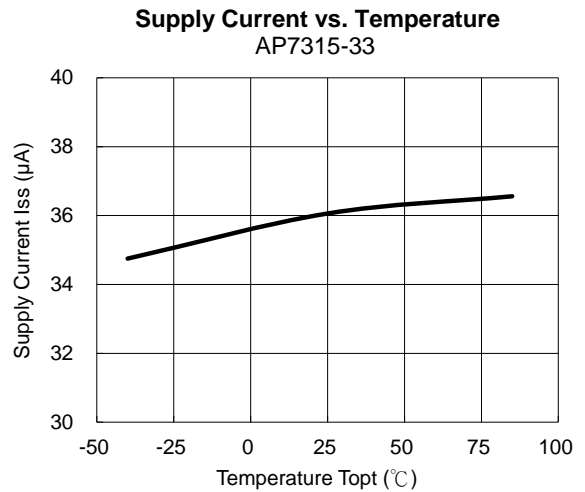
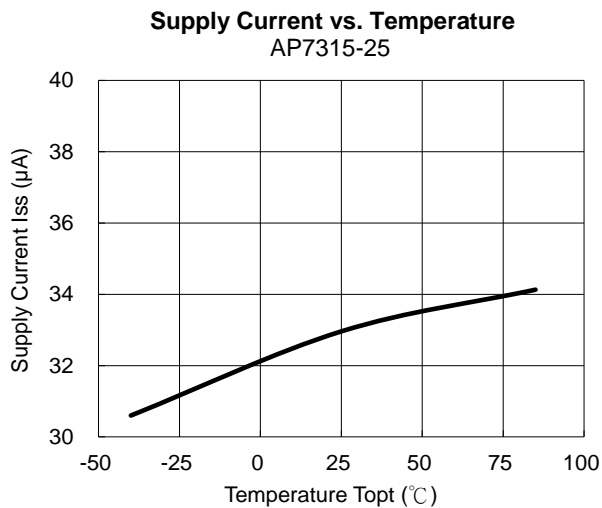
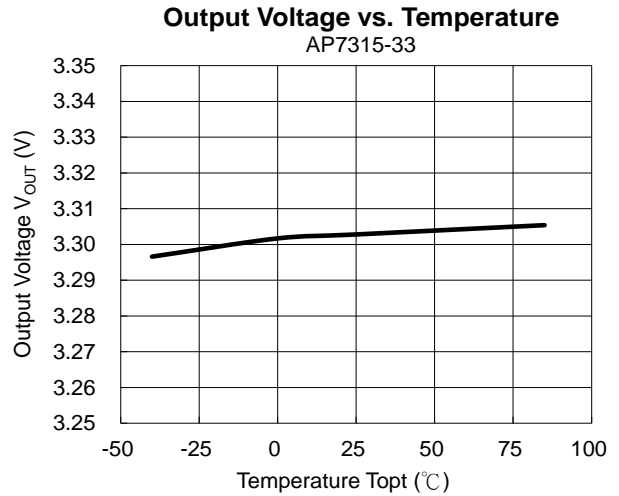
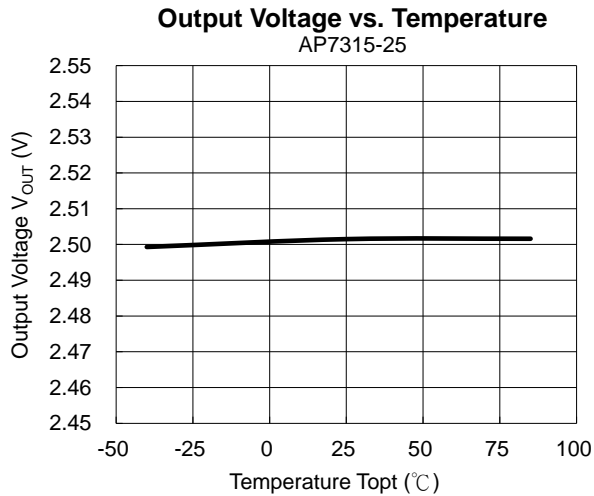
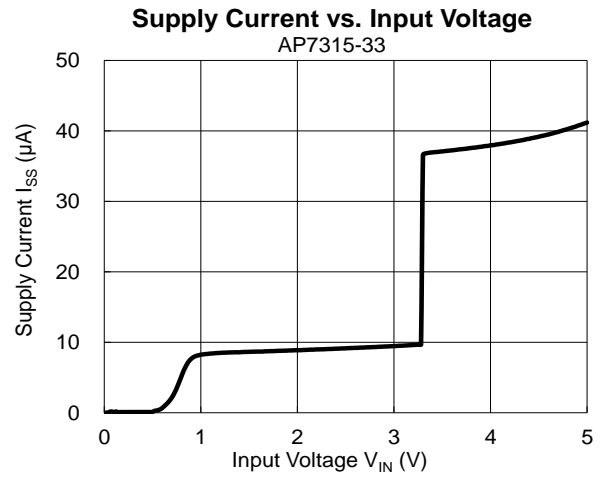
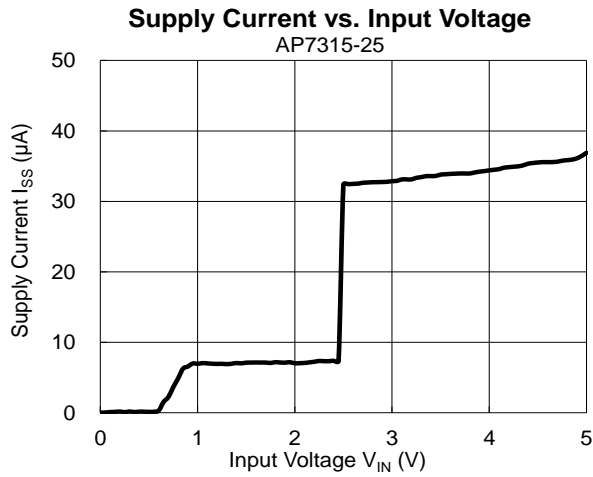

Typical Characteristics (Continued)

Dropout Voltage vs. Output Current
AP7315-25

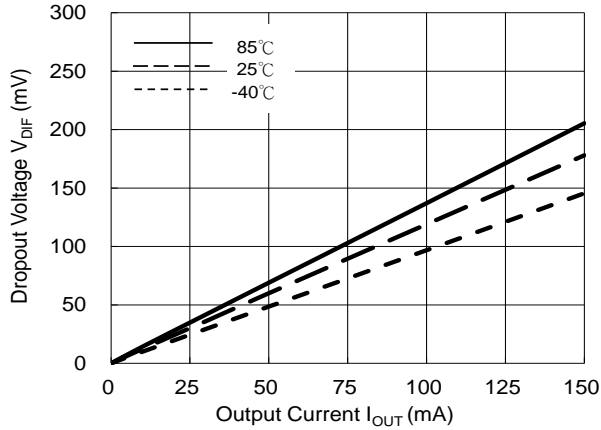

Dropout Voltage vs. Output Current
AP7315-33

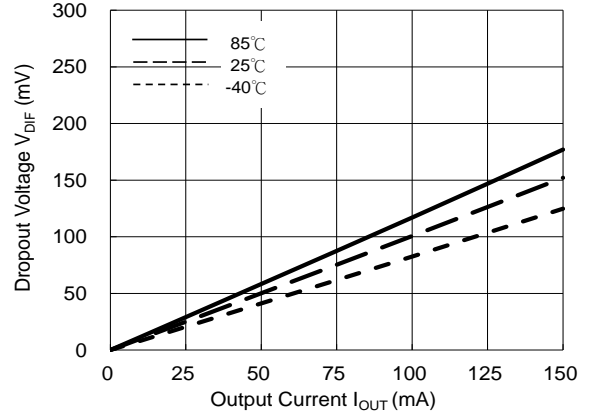

Dropout Voltage vs. Temperature
AP7315-25

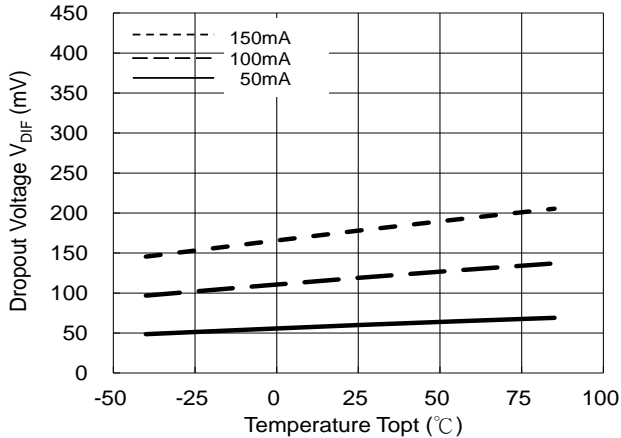

Dropout Voltage vs. Temperature
AP7315-33

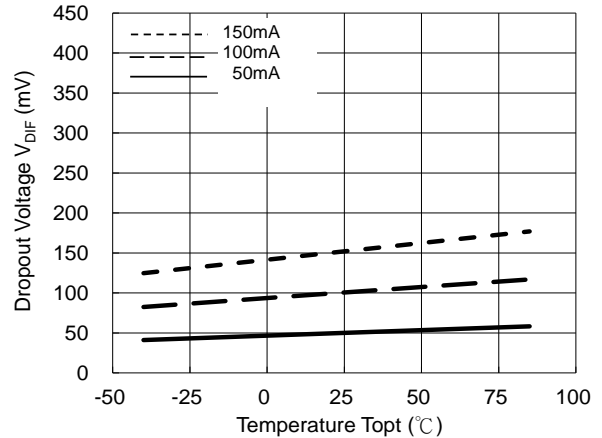

Ripple Rejection vs. Frequency
AP7315-18

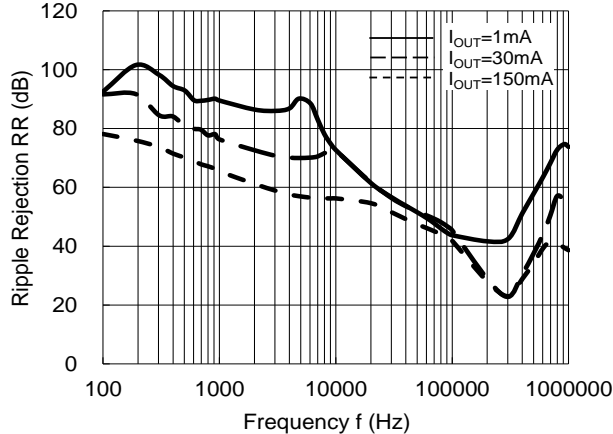

Ripple Rejection vs. Frequency
AP7315-25

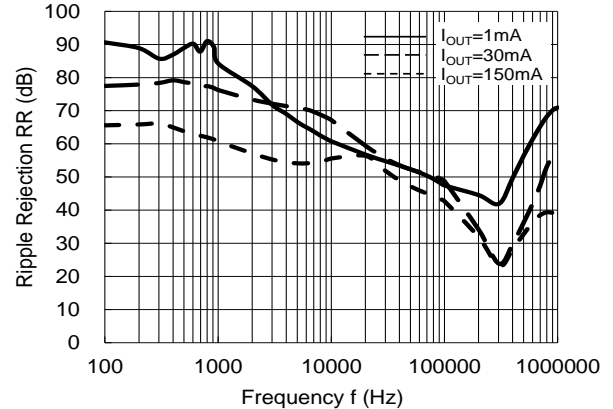

Typical Characteristics (Continued)

Ripple Rejection vs. Frequency
AP7315-33

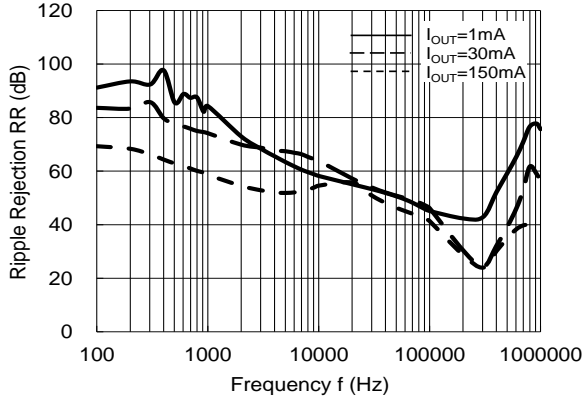

AP7315-25

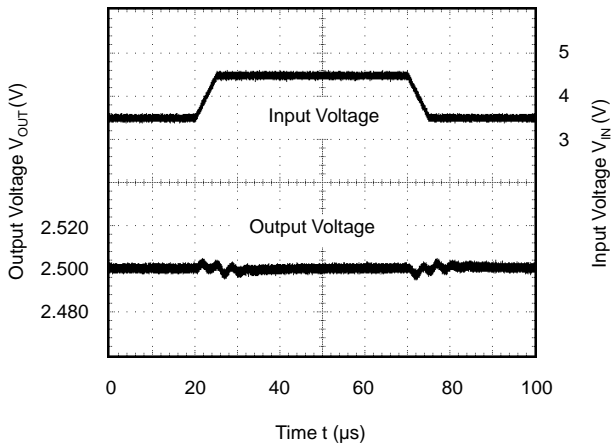

AP7315-33

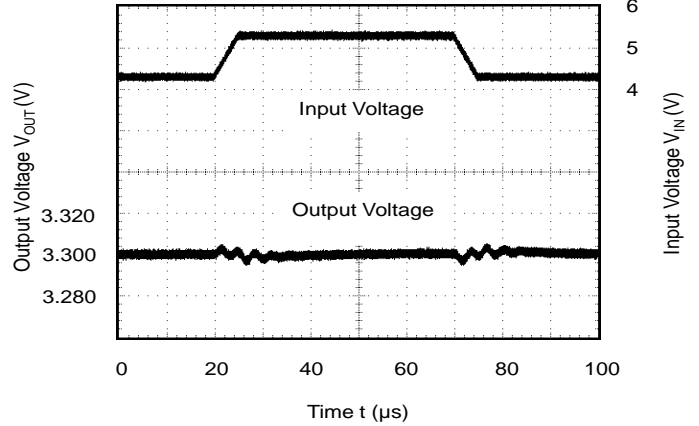

AP7315-25 $V_{IN} = 3.5\text{V}$
 $tr = tf = 0.5\mu\text{s}$

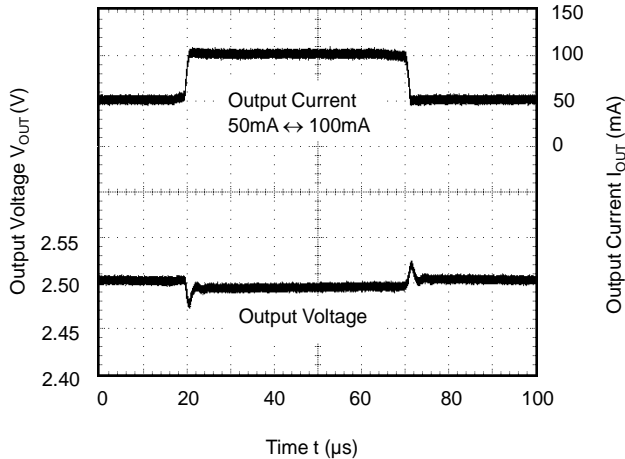

AP7315-33 $V_{IN} = 4.3\text{V}$
 $tr = tf = 0.5\mu\text{s}$

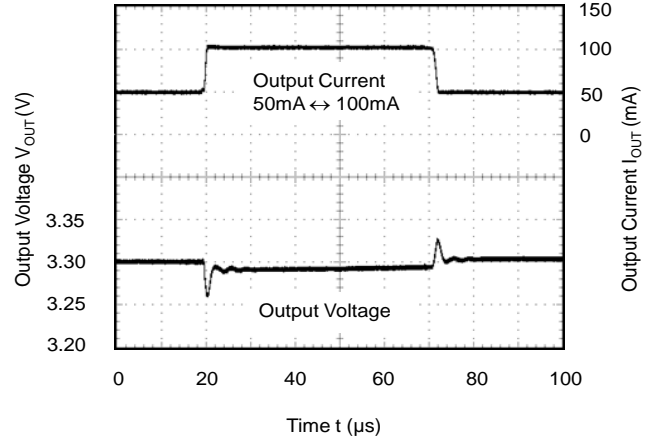

Typical Characteristics (Continued)

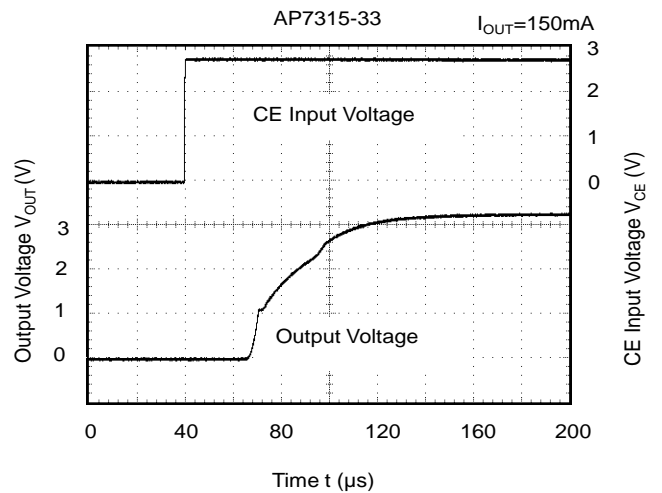
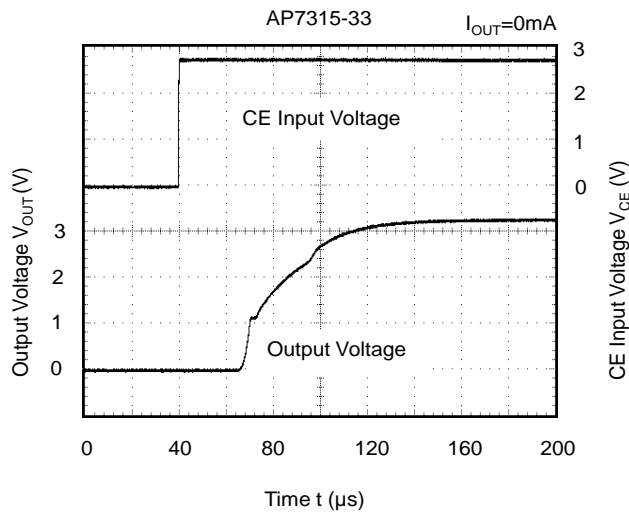
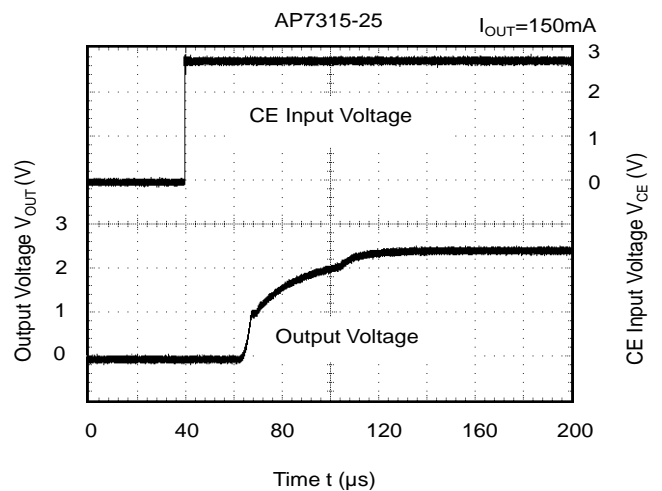
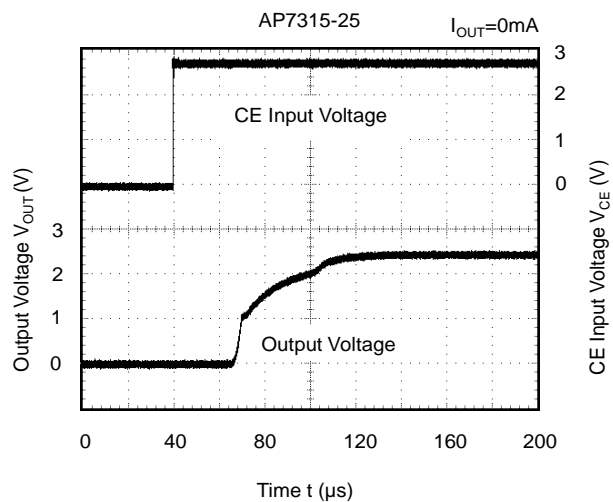
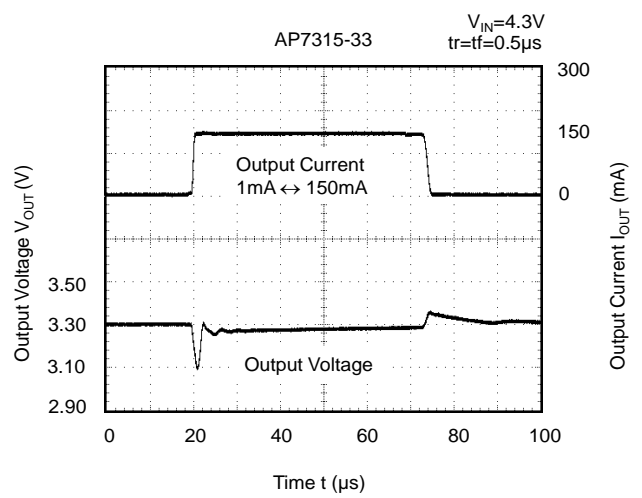
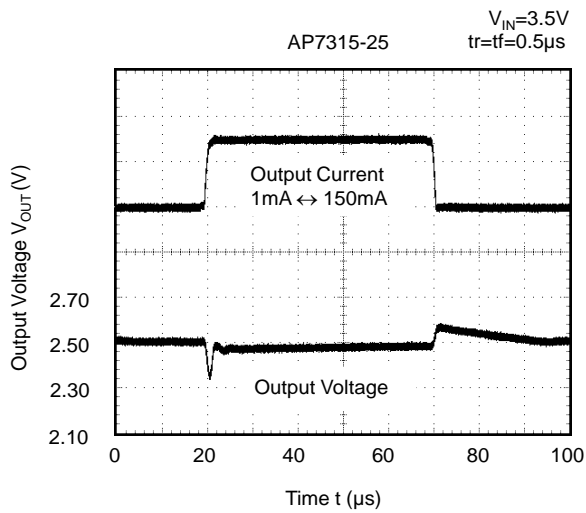

Typical Characteristics (Continued)

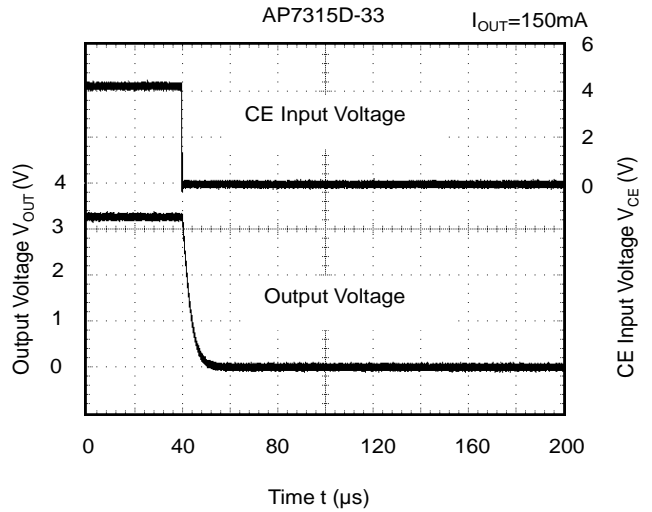
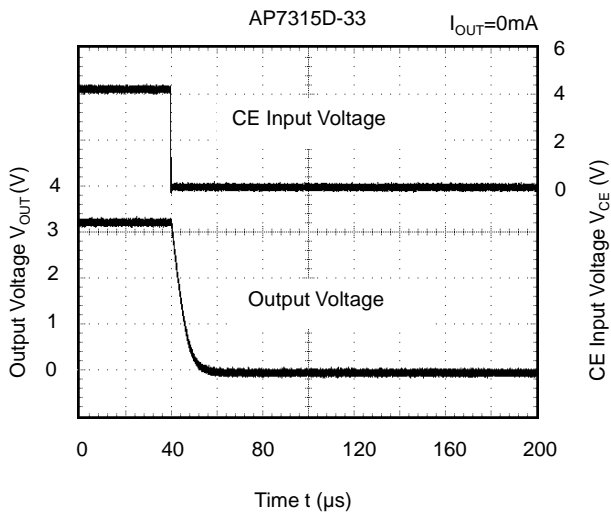
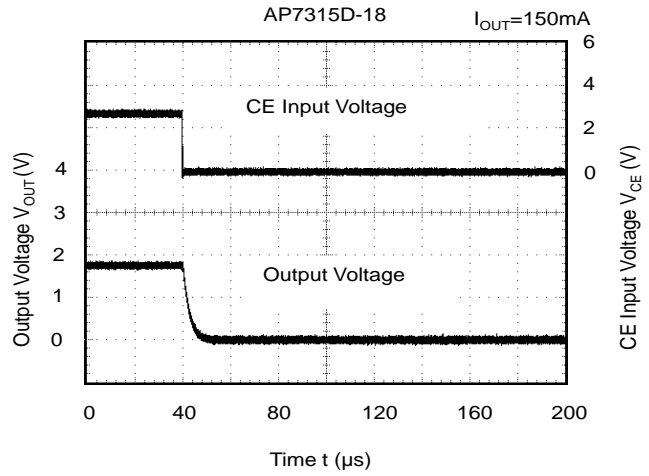
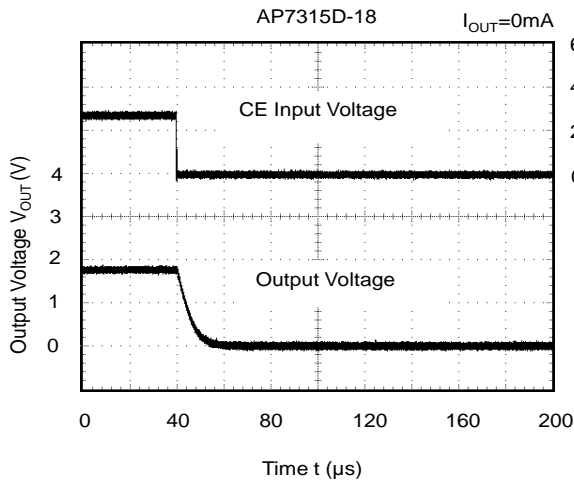

Application Information

Output Capacitor

An output capacitor (C_{OUT}) is needed to improve transient response and maintain stability. The AP7315 is stable with very small ceramic output capacitors. The ESR (equivalent series resistance) and capacitance drives the selection. If the application has large load variations, it is recommended to utilize low-ESR bulk capacitors. It is recommended to place ceramic capacitors as close as possible to the load and the ground pin and care should be taken to reduce the impedance in the layout.

Input Capacitor

To prevent the input voltage from dropping during load steps, it is recommended to utilize an input capacitor (C_{IN}). A minimum 0.47 μ F ceramic capacitor is recommended between V_{IN} and GND pins to decouple input power supply glitch. This input capacitor must be located as close as possible to the device to assure input stability and reduce noise. For PCB layout, a wide copper trace is required for both V_{IN} and GND pins.

Enable Control

The AP7315 is turned on by setting the EN pin high, and is turned off by pulling it low. If this feature is not used, the EN pin should be tied to V_{IN} pin to keep the regulator output on at all time. To ensure proper operation, the signal source used to drive the EN pin must be able to swing above and below the specified turn-on/off voltage thresholds listed in the Electrical Characteristics section.

Short Circuit Protection

When V_{OUT} pin is short-circuit to GND, short circuit protection will be triggered and clamp the output current to approximately 60mA. This feature protects the regulator from overcurrent and damage due to overheating.

Layout Considerations

For good ground loop and stability, the input and output capacitors should be located close to the V_{IN} , V_{OUT} , and GND pins of the device. The regulator GND pin should be connected to the external circuit ground to reduce voltage drop caused by trace impedance. Ground plane is generally used to reduce trace impedance. Wide trace should be used for large current paths from V_{IN} to V_{OUT} , and load circuit.

ESR vs. Output Current

Ceramic type output capacitor is recommended for this series; however, the other output capacitors with low ESR also can be used. The relations between I_{OUT} (Output Current) and ESR of an output capacitor are shown below. The stable region is marked as the hatched area in the graph.

Measurement conditions:

Frequency Band: 10Hz to 2MHz, Temperature: -40°C to +85°C

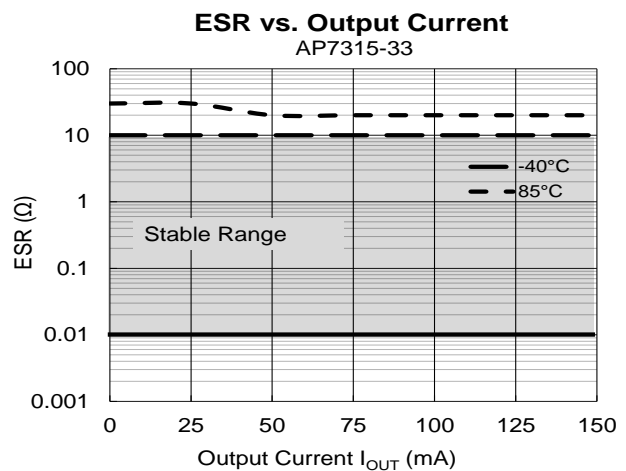
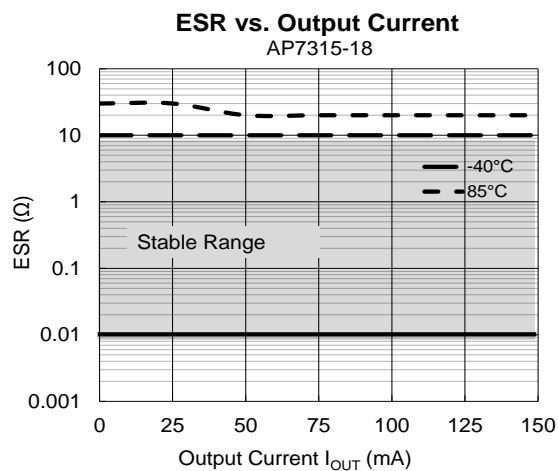

Ordering Information (Note 12)

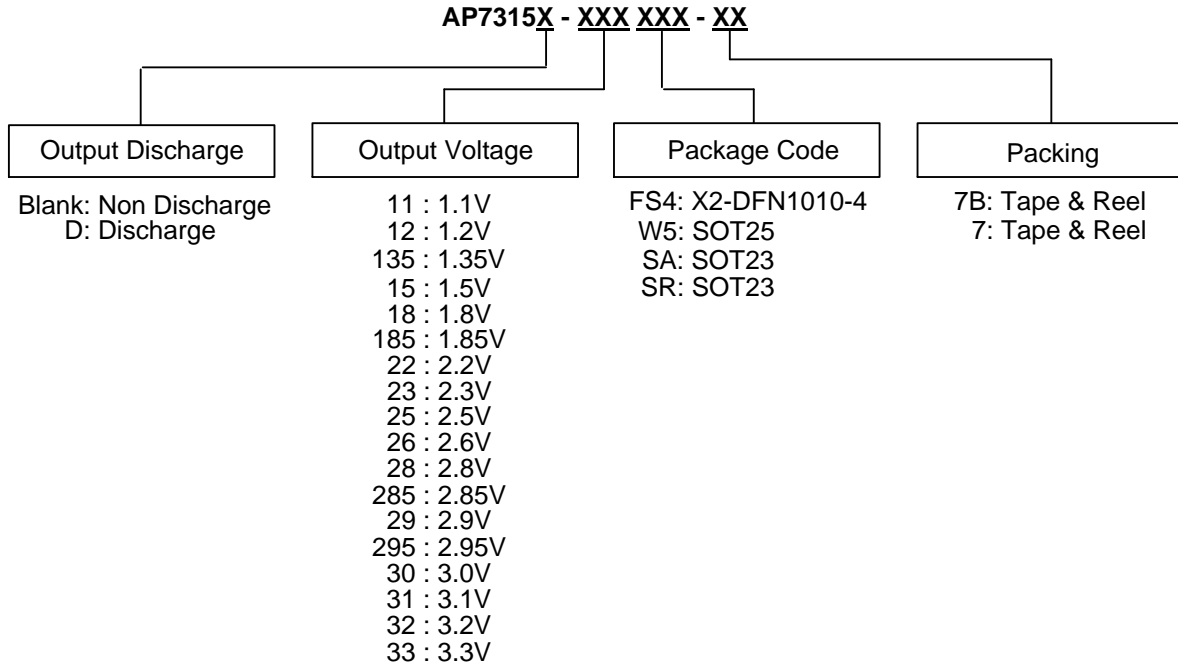

Part Number	Package Code	Packaging	7" Tape and Reel	
			Quantity	Part Number Suffix
AP7315-XXXFS4-7B	FS4	X2-DFN1010-4	10000/Tape & Reel	-7B
AP7315D-XXXFS4-7B	FS4	X2-DFN1010-4	10000/Tape & Reel	-7B
AP7315-XXXW5-7	W5	SOT25	3000/Tape & Reel	-7
AP7315D-XXXW5-7	W5	SOT25	3000/Tape & Reel	-7
AP7315-XXXSA-7	SA	SOT23	3000/Tape & Reel	-7
AP7315-XXXSR-7	SR	SOT23	3000/Tape & Reel	-7

Note: 12. For packaging details, go to our website at <http://www.diodes.com/products/packages.html>.

Marking Information

(1) X2-DFN1010-4

(Top View)

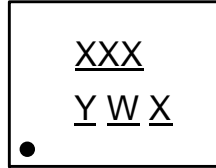

XXX : Identification Code

Y : Year : 0~9

W : Week : A~Z : 1~26 week;

a~z : 27~52 week; z represents
52 and 53 week

X : Internal Code

Part Number	Package	Identification Code
AP7315-11FS4-7B	X2-DFN1010-4	15A
AP7315-12FS4-7B	X2-DFN1010-4	15B
AP7315-13FS4-7B	X2-DFN1010-4	15C
AP7315-15FS4-7B	X2-DFN1010-4	15D
AP7315-18FS4-7B	X2-DFN1010-4	15E
AP7315-185FS4-7B	X2-DFN1010-4	15F
AP7315-22FS4-7B	X2-DFN1010-4	15G
AP7315-23FS4-7B	X2-DFN1010-4	15H
AP7315-25FS4-7B	X2-DFN1010-4	15J
AP7315-26FS4-7B	X2-DFN1010-4	15K
AP7315-28FS4-7B	X2-DFN1010-4	15M
AP7315-285FS4-7B	X2-DFN1010-4	15N
AP7315-295FS4-7B	X2-DFN1010-4	15P
AP7315-30FS4-7B	X2-DFN1010-4	15R
AP7315-31FS4-7B	X2-DFN1010-4	15S
AP7315-32FS4-7B	X2-DFN1010-4	15T
AP7315-33FS4-7B	X2-DFN1010-4	15U
AP7315D-11FS4-7B	X2-DFN1010-4	5DA
AP7315D-12FS4-7B	X2-DFN1010-4	5DB
AP7315D-135FS4-7B	X2-DFN1010-4	5DC
AP7315D-15FS4-7B	X2-DFN1010-4	5DD
AP7315D-18FS4-7B	X2-DFN1010-4	5DE
AP7315D-185FS4-7B	X2-DFN1010-4	5DF
AP7315D-22FS4-7B	X2-DFN1010-4	5DG
AP7315D-23FS4-7B	X2-DFN1010-4	5DH
AP7315D-25FS4-7B	X2-DFN1010-4	5DJ
AP7315D-26FS4-7B	X2-DFN1010-4	5DK
AP7315D-28FS4-7B	X2-DFN1010-4	5DM
AP7315D-285FS4-7B	X2-DFN1010-4	5DN
AP7315D-29FS4-7B	X2-DFN1010-4	5DP
AP7315D-295FS4-7B	X2-DFN1010-4	5DR
AP7315D-30FS4-7B	X2-DFN1010-4	5DS
AP7315D-31FS4-7B	X2-DFN1010-4	5DT
AP7315D-32FS4-7B	X2-DFN1010-4	5DU
AP7315D-33FS4-7B	X2-DFN1010-4	5DV

Marking Information (Continued)

(2) SOT25

(Top View)

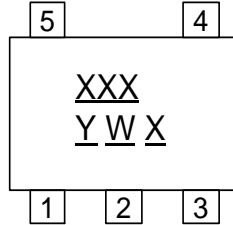

XXX : Identification Code
Y : Year 0 to 9
W : Week : A to Z : 1 to 26 week;
 a to z : 27 to 52 week; z represents
 52 and 53 week
X : Internal Code

Part Number	Package	Identification Code
AP7315-11W5-7	SOT25	15A
AP7315-12W5-7	SOT25	15B
AP7315-135W5-7	SOT25	15C
AP7315-15W5-7	SOT25	15D
AP7315-18W5-7	SOT25	15E
AP7315-185W5-7	SOT25	15F
AP7315-22W5-7	SOT25	15G
AP7315-23W5-7	SOT25	15H
AP7315-25W5-7	SOT25	15J
AP7315-26W5-7	SOT25	15K
AP7315-28W5-7	SOT25	15M
AP7315-285W5-7	SOT25	15N
AP7315-295W5-7	SOT25	15P
AP7315-30W5-7	SOT25	15R
AP7315-31W5-7	SOT25	15S
AP7315-32W5-7	SOT25	15T
AP7315-33W5-7	SOT25	15U
AP7315D-11W5-7	SOT25	5DA
AP7315D-12W5-7	SOT25	5DB
AP7315D-135W5-7	SOT25	5DC
AP7315D-15W5-7	SOT25	5DD
AP7315D-18W5-7	SOT25	5DE
AP7315D-185W5-7	SOT25	5DF
AP7315D-22W5-7	SOT25	5DG
AP7315D-23W5-7	SOT25	5DH
AP7315D-25W5-7	SOT25	5DJ
AP7315D-26W5-7	SOT25	5DK
AP7315D-28W5-7	SOT25	5DM
AP7315D-285W5-7	SOT25	5DN
AP7315D-29W5-7	SOT25	5DP
AP7315D-295W5-7	SOT25	5DR
AP7315D-30W5-7	SOT25	5DS
AP7315D-31W5-7	SOT25	5DT
AP7315D-32W5-7	SOT25	5DU
AP7315D-33W5-7	SOT25	5DV

Marking Information (Continued)

(3) SOT23

(Top View)

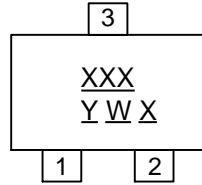

XXX : Identification Code
Y : Year 0 to 9
W : Week : A to Z : 1 to 26 week;
 a to z : 27 to 52 week; z represents
 52 and 53 week
X : Internal Code

Part Number	Package	Identification Code
AP7315-11SA-7	SOT23	15A
AP7315-12SA-7	SOT23	15B
AP7315-135SA-7	SOT23	15C
AP7315-15SA-7	SOT23	15D
AP7315-18SA-7	SOT23	15E
AP7315-185SA-7	SOT23	15F
AP7315-22SA-7	SOT23	15G
AP7315-23SA-7	SOT23	15H
AP7315-25SA-7	SOT23	15J
AP7315-26SA-7	SOT23	15K
AP7315-28SA-7	SOT23	15M
AP7315-285SA-7	SOT23	15N
AP7315-295SA-7	SOT23	15P
AP7315-30SA-7	SOT23	15R
AP7315-31SA-7	SOT23	15S
AP7315-32SA-7	SOT23	15T
AP7315-33SA-7	SOT23	15U
AP7315-11SR-7	SOT23	5DA
AP7315-12SR-7	SOT23	5DB
AP7315-135SR-7	SOT23	5DC
AP7315-15SR-7	SOT23	5DD
AP7315-18SR-7	SOT23	5DE
AP7315-185SR7	SOT23	5DF
AP7315-22SR-7	SOT23	5DG
AP7315-23SR-7	SOT23	5DH
AP7315-25SR-7	SOT23	5DJ
AP7315-26SR-7	SOT23	5DK
AP7315-28SR-7	SOT23	5DM
AP7315-285SR-7	SOT23	5DN
AP7315-295SR-7	SOT23	5DR
AP7315-30SR-7	SOT23	5DS
AP7315-31SR-7	SOT23	5DT
AP7315-32SR-7	SOT23	5DU
AP7315-33SR-7	SOT23	5DV

Package Outline Dimensions

Please see <http://www.diodes.com/package-outlines.html> for the latest version.

(1) Package Type: X2-DFN1010-4

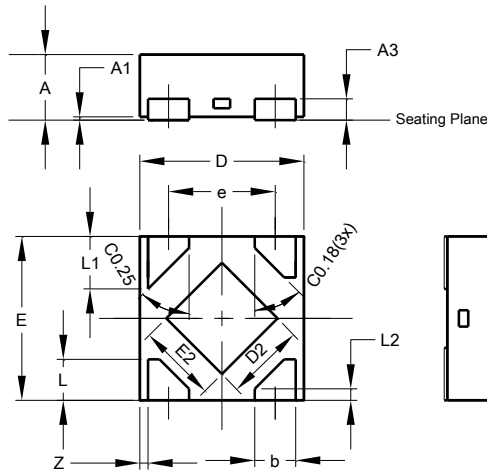

X2-DFN1010-4			
Dim	Min	Max	Typ
A	-	0.40	0.39
A1	0.00	0.05	0.02
A3	-	-	0.13
b	0.20	0.30	0.25
D	0.95	1.05	1.00
D2	0.38	0.58	0.48
E	0.95	1.05	1.00
E2	0.38	0.58	0.48
e	-	-	0.65
L	0.20	0.30	0.25
L1	0.27	0.37	0.32
L2	0.02	0.12	0.07
Z	-	-	0.050
All Dimensions in mm			

Package Outline Dimensions (All dimensions in mm.)

(2) Package Type: SOT23

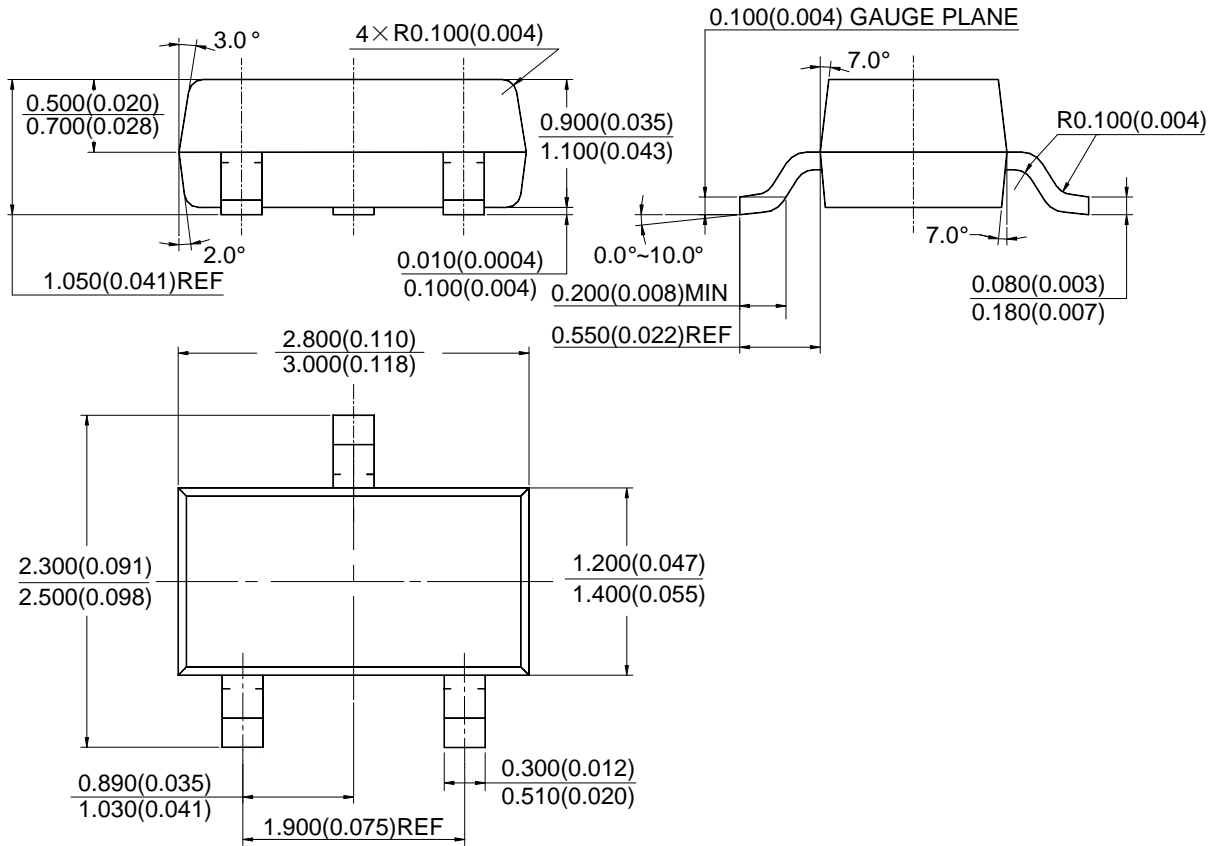

Package Outline Dimensions (All dimensions in mm.)

(3) Package Type: SOT25

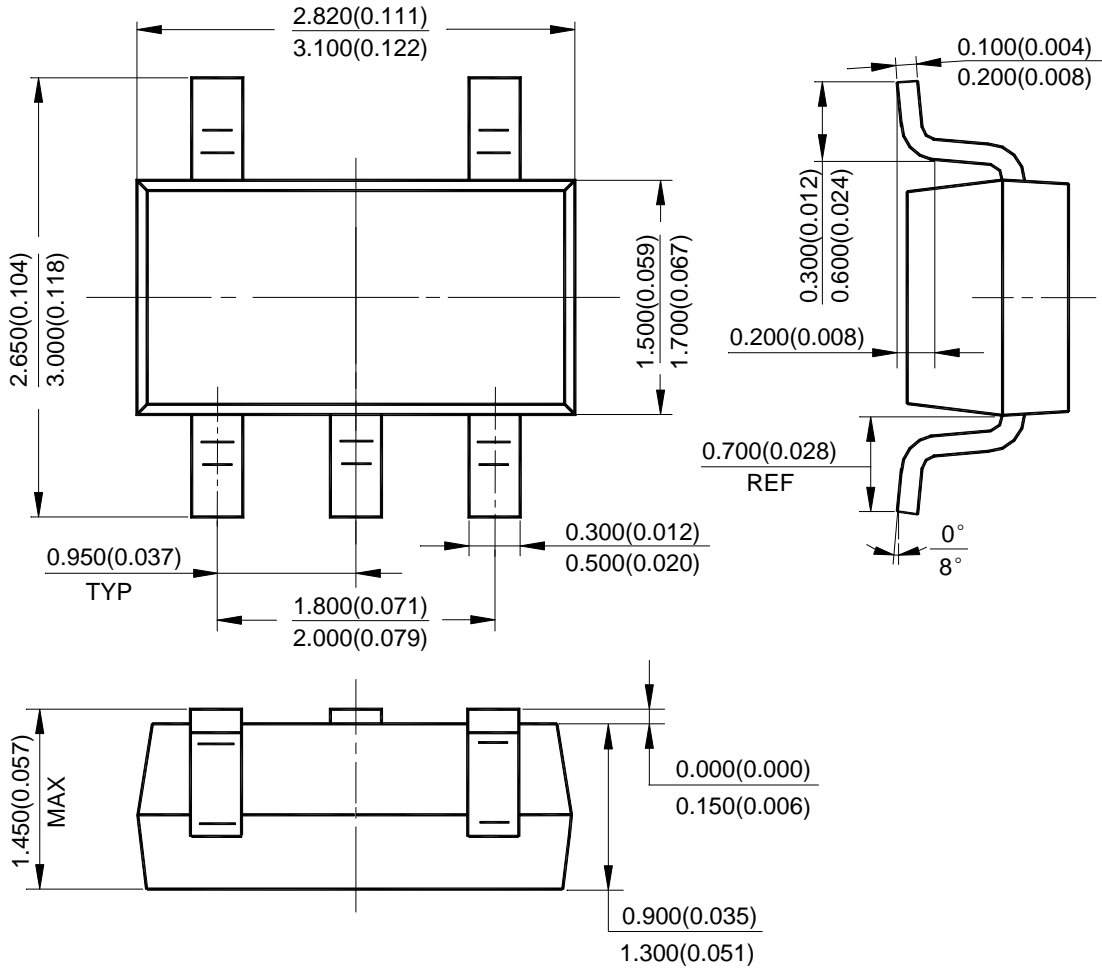

Suggested Pad Layout

Please see <http://www.diodes.com/package-outlines.html> for the latest version.

(1) Package Type: X2-DFN1010-4

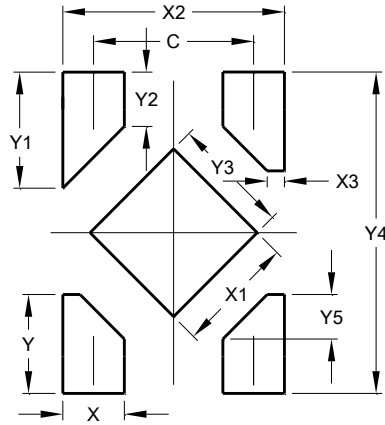

Dimensions	Value (in mm)
C	0.650
X	0.250
X1	0.480
X2	0.900
X3	0.070
Y	0.400
Y1	0.470
Y2	0.220
Y3	0.480
Y4	1.300
Y5	0.180

Suggested Pad Layout (Continued)

(2) Package Type: SOT23

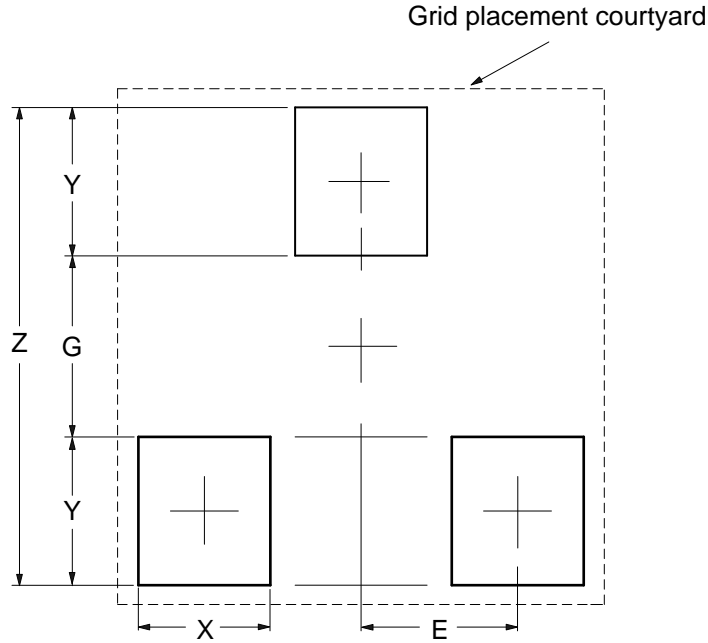

Dimensions	Z (mm)/(inch)	G (mm)/(inch)	X (mm)/(inch)	Y (mm)/(inch)	E (mm)/(inch)
Value	2.900/0.114	1.100/0.043	0.800/0.031	0.900/0.035	0.950/0.037

Suggested Pad Layout (Continued)

(3) Package Type: SOT25

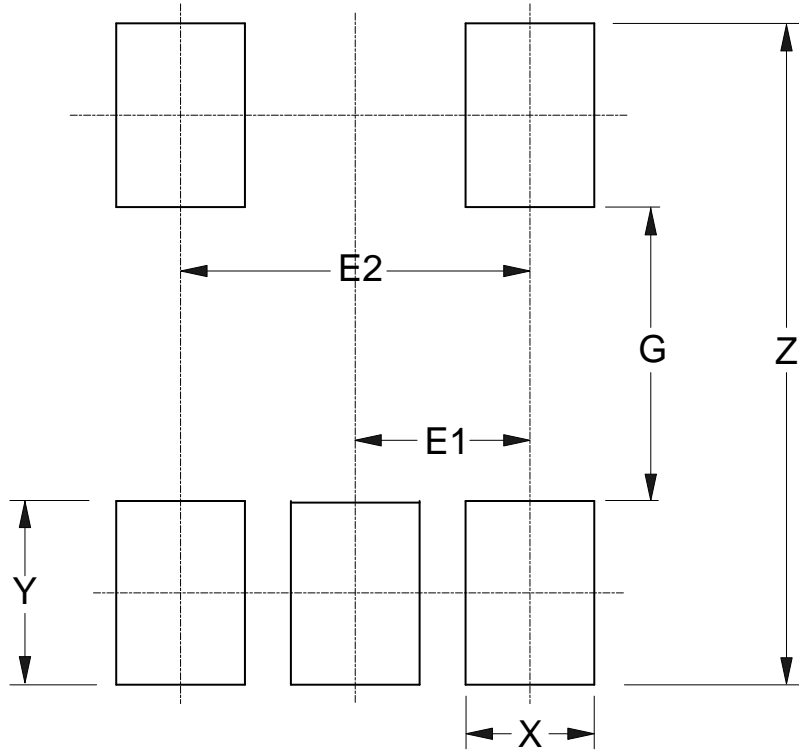

Dimensions	Z (mm)/(inch)	G (mm)/(inch)	X (mm)/(inch)	Y (mm)/(inch)	E1 (mm)/(inch)	E2 (mm)/(inch)
Value	3.600/0.142	1.600/0.063	0.700/0.028	1.000/0.039	0.950/0.037	1.900/0.075

Tape Orientation

For AP7315-XXXFS4-7B & AP7315D-XXXFS4-7B

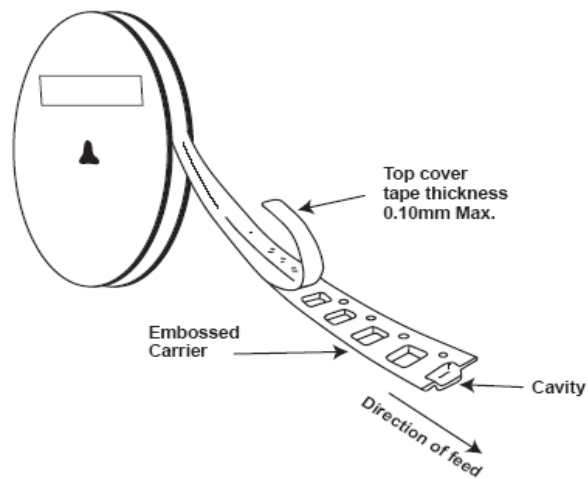
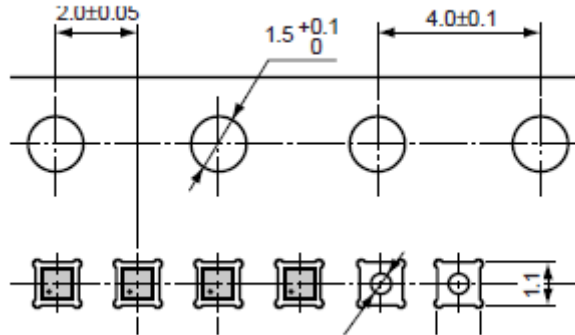

Note: 13. The taping orientation of the other package type can be found on our website at <https://www.diodes.com/assets/Packaging-Support-Docs/ap02007.pdf>.

Mechanical Data

- Moisture Sensitivity: Level 1 Per J-STD-020
- Terminals:
 - SOT23, SOT25: Finish - Matte Tin Plated Leads, Solderable per MIL-STD-202, Method 208 ^(e3)
 - X2-DFN1010-4: Finish - NiPdAu over Copper Leads, Solderable per MIL-STD-202, Method 208 ^(e4)
- Weight:
 - SOT23: 0.009 grams (Approximate)
 - SOT25: 0.016 grams (Approximate)
 - X2-DFN1010-4 (Type B): 0.001 grams (Approximate)

IMPORTANT NOTICE

1. DIODES INCORPORATED AND ITS SUBSIDIARIES (“DIODES”) MAKE NO WARRANTY OF ANY KIND, EXPRESS OR IMPLIED, WITH REGARDS TO ANY INFORMATION CONTAINED IN THIS DOCUMENT, INCLUDING, BUT NOT LIMITED TO, THE IMPLIED WARRANTIES OF MERCHANTABILITY, FITNESS FOR A PARTICULAR PURPOSE OR NON-INFRINGEMENT OF THIRD PARTY INTELLECTUAL PROPERTY RIGHTS (AND THEIR EQUIVALENTS UNDER THE LAWS OF ANY JURISDICTION).
2. The Information contained herein is for informational purpose only and is provided only to illustrate the operation of Diodes products described herein and application examples. Diodes does not assume any liability arising out of the application or use of this document or any product described herein. This document is intended for skilled and technically trained engineering customers and users who design with Diodes products. Diodes products may be used to facilitate safety-related applications; however, in all instances customers and users are responsible for (a) selecting the appropriate Diodes products for their applications, (b) evaluating the suitability of the Diodes products for their intended applications, (c) ensuring their applications, which incorporate Diodes products, comply the applicable legal and regulatory requirements as well as safety and functional-safety related standards, and (d) ensuring they design with appropriate safeguards (including testing, validation, quality control techniques, redundancy, malfunction prevention, and appropriate treatment for aging degradation) to minimize the risks associated with their applications.
3. Diodes assumes no liability for any application-related information, support, assistance or feedback that may be provided by Diodes from time to time. Any customer or user of this document or products described herein will assume all risks and liabilities associated with such use, and will hold Diodes and all companies whose products are represented herein or on Diodes’ websites, harmless against all damages and liabilities.
4. Products described herein may be covered by one or more United States, international or foreign patents and pending patent applications. Product names and markings noted herein may also be covered by one or more United States, international or foreign trademarks and trademark applications. Diodes does not convey any license under any of its intellectual property rights or the rights of any third parties (including third parties whose products and services may be described in this document or on Diodes’ website) under this document.
5. Diodes products are provided subject to Diodes’ Standard Terms and Conditions of Sale (<https://www.diodes.com/about/company/terms-and-conditions/terms-and-conditions-of-sales/>) or other applicable terms. This document does not alter or expand the applicable warranties provided by Diodes. Diodes does not warrant or accept any liability whatsoever in respect of any products purchased through unauthorized sales channel.
6. Diodes products and technology may not be used for or incorporated into any products or systems whose manufacture, use or sale is prohibited under any applicable laws and regulations. Should customers or users use Diodes products in contravention of any applicable laws or regulations, or for any unintended or unauthorized application, customers and users will (a) be solely responsible for any damages, losses or penalties arising in connection therewith or as a result thereof, and (b) indemnify and hold Diodes and its representatives and agents harmless against any and all claims, damages, expenses, and attorney fees arising out of, directly or indirectly, any claim relating to any noncompliance with the applicable laws and regulations, as well as any unintended or unauthorized application.
7. While efforts have been made to ensure the information contained in this document is accurate, complete and current, it may contain technical inaccuracies, omissions and typographical errors. Diodes does not warrant that information contained in this document is error-free and Diodes is under no obligation to update or otherwise correct this information. Notwithstanding the foregoing, Diodes reserves the right to make modifications, enhancements, improvements, corrections or other changes without further notice to this document and any product described herein. This document is written in English but may be translated into multiple languages for reference. Only the English version of this document is the final and determinative format released by Diodes.
8. Any unauthorized copying, modification, distribution, transmission, display or other use of this document (or any portion hereof) is prohibited. Diodes assumes no responsibility for any losses incurred by the customers or users or any third parties arising from any such unauthorized use.

Copyright © 2021 Diodes Incorporated

www.diodes.com

Looking for pricing, stock, or lifecycle information?

Click below to explore more details on WIN SOURCE:

- ⊖ [View AP7315D-28W5-7 on WIN SOURCE](#)
- ⊖ [Diodes Incorporated Information](#)

Optimize Your Supply Chain with WIN SOURCE Solutions

- ✓ Global Sourcing Solution
- ✓ Obsolete Management
- ✓ Cost Control Management
- ✓ Shortage Management
- ✓ Alternative Solution
- ✓ Excess Inventory Management