

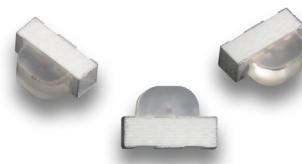

**THE DATASHEET OF  
APA3010F3C-GX**





## APA3010F3C-GX

3.0 mm x 1.0 mm Right Angle Infrared Emitting Diode

### DESCRIPTION

- F3 Made with Gallium Arsenide Infrared Emitting diodes

### FEATURES

- 3.0 x 2.0 x 1.0 mm right angle SMD LED, 1.0 mm thickness
- Mechanically and spectrally matched to the phototransistor
- Package: 2000 pcs / reel
- Moisture sensitivity level: 3
- Tinned pads for improved solderability
- Halogen-free
- RoHS compliant

### APPLICATIONS

- Infrared Illumination for cameras
- Machine vision systems
- Surveillance systems
- Industrial electronics
- IR data transmission
- Remote control

### PACKAGE DIMENSIONS

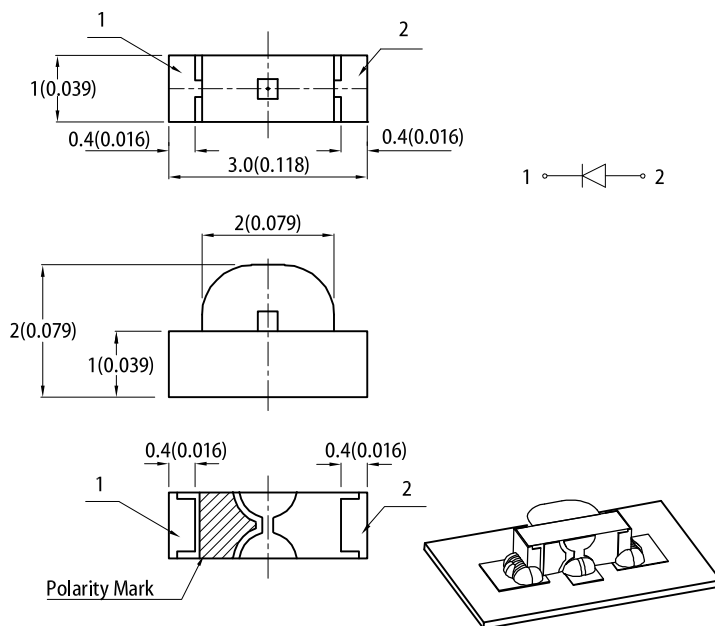

### RECOMMENDED SOLDERING PATTERN

(units : mm; tolerance : ± 0.1)

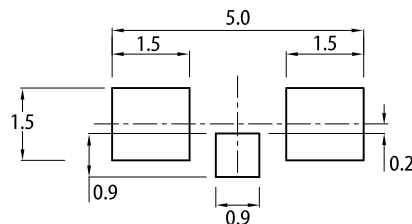

#### Notes:

- All dimensions are in millimeters (inches).
- Tolerance is  $\pm 0.15(0.006)$  unless otherwise noted.
- The specifications, characteristics and technical data described in the datasheet are subject to change without prior notice.
- The device has a single mounting surface. The device must be mounted according to the specifications.
- For right angle SMD LEDs, the solder stencil should be at least 5mil in thickness, to prevent poor solder wetting due to insufficient solder paste.

### SELECTION GUIDE

Part Number	Emitting Color (Material)	Lens Type	Po (mW/sr) @ 20mA <sup>[2]</sup>		Viewing Angle <sup>[1]</sup>
			Min.	Typ.	2θ1/2
APA3010F3C-GX	Infrared (GaAs)	Water Clear	1.2	3	160°
			*0.8	*2	

Notes:  
1. θ1/2 is the angle from optical centerline where the luminous intensity is 1/2 of the optical peak value.

2. Radiant Intensity / luminous flux: +/-15%.

\* Radiant intensity value is traceable to CIE127-2007 standards.

ELECTRICAL / OPTICAL CHARACTERISTICS at  $T_A=25^{\circ}\text{C}$ 

Parameter	Symbol	Emitting Color	Value		Unit
			Typ.	Max.	
Wavelength at Peak Emission $I_F = 20\text{mA}$	$\lambda_{\text{peak}}$	Infrared	940	-	nm
Spectral Bandwidth at 50% $\Phi$ REL MAX $I_F = 20\text{mA}$	$\Delta\lambda$	Infrared	50	-	nm
Capacitance	C	Infrared	90	-	pF
Forward Voltage $I_F = 20\text{mA}$	$V_F$ <sup>[1]</sup>	Infrared	1.2	1.6	V
Reverse Current ( $V_R = 5\text{V}$ )	$I_R$	Infrared	-	10	$\mu\text{A}$
Temperature Coefficient of Wavelength $I_F = 20\text{mA}$ , $-10^{\circ}\text{C} \leq T \leq 85^{\circ}\text{C}$	$\text{TC}_{\lambda}$	Infrared	0.3	-	nm/ $^{\circ}\text{C}$
Temperature Coefficient of $V_F$ $I_F = 20\text{mA}$ , $-10^{\circ}\text{C} \leq T \leq 85^{\circ}\text{C}$	$\text{TC}_V$	Infrared	-1.2	-	mV/ $^{\circ}\text{C}$

## Notes:

1. Forward voltage:  $\pm 0.1\text{V}$ .
2. Wavelength value is traceable to CIE127-2007 standards.
3. Excess driving current and / or operating temperature higher than recommended conditions may result in severe light degradation or premature failure.

ABSOLUTE MAXIMUM RATINGS at  $T_A=25^{\circ}\text{C}$ 

Parameter	Symbol	Value	Unit
Power Dissipation	$P_D$	90	mW
Reverse Voltage	$V_R$	5	V
Junction Temperature	$T_j$	115	$^{\circ}\text{C}$
Operating Temperature	$T_{\text{op}}$	-40 to +85	$^{\circ}\text{C}$
Storage Temperature	$T_{\text{stg}}$	-40 to +85	$^{\circ}\text{C}$
DC Forward Current	$I_F$	50	mA
Peak Forward Current	$I_{\text{FM}}$ <sup>[1]</sup>	1.2	A
Electrostatic Discharge Threshold (HBM)	-	8000	V
Thermal Resistance (Junction / Ambient)	$R_{\text{th JA}}$ <sup>[2]</sup>	470	$^{\circ}\text{C}/\text{W}$
Thermal Resistance (Junction / Solder point)	$R_{\text{th JS}}$ <sup>[2]</sup>	330	$^{\circ}\text{C}/\text{W}$

## Notes:

1. 1/100 Duty Cycle, 10 $\mu\text{s}$  Pulse Width.
2.  $R_{\text{th JA}}$ ,  $R_{\text{th JS}}$  Results from mounting on PC board FR4 (pad size  $\geq 16\text{ mm}^2$  per pad).
3. Relative humidity levels maintained between 40% and 60% in production area are recommended to avoid the build-up of static electricity – Ref JEDEC/JESD625-A and JEDEC/J-STD-033.

### TECHNICAL DATA

#### RELATIVE INTENSITY vs. WAVELENGTH

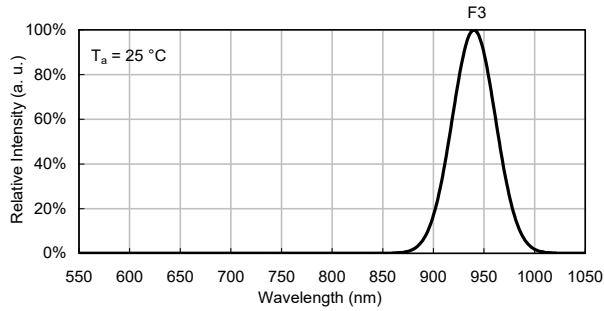

#### SPATIAL DISTRIBUTION

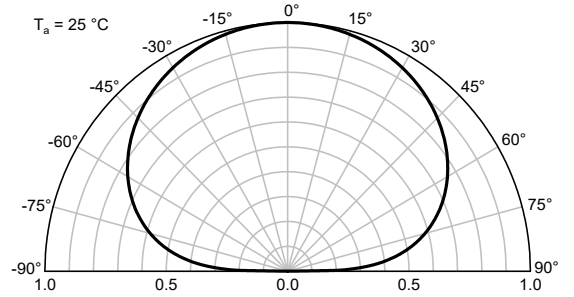

### INFRARED

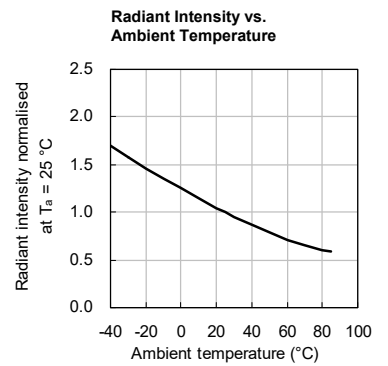
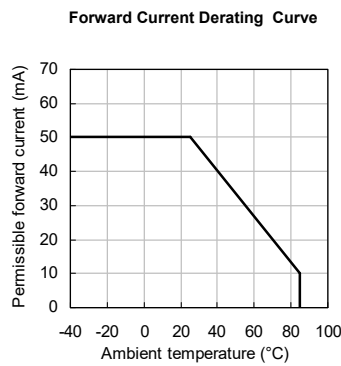
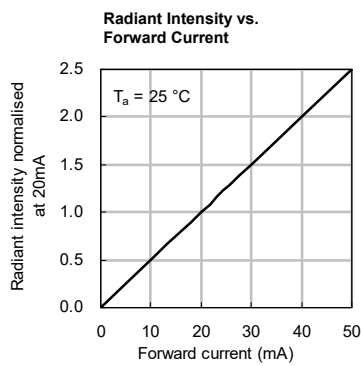
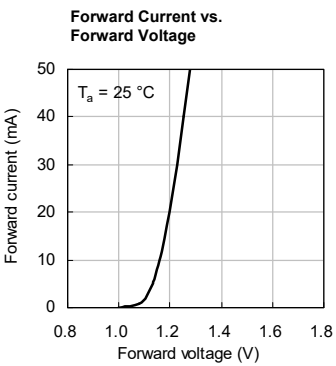

#### REFLOW SOLDERING PROFILE for LEAD-FREE SMD PROCESS

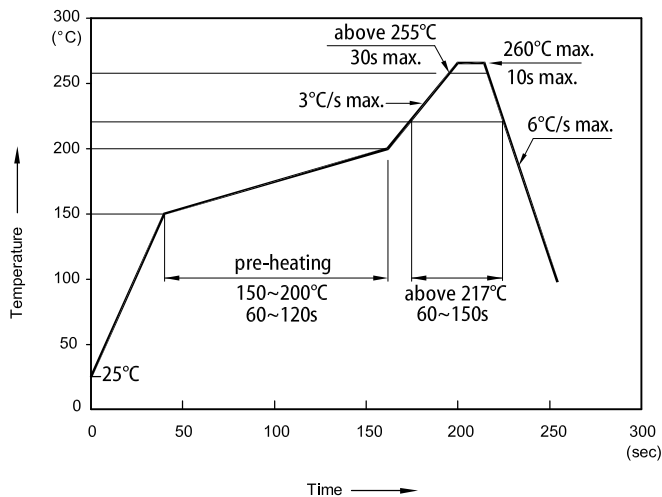

#### TAPE SPECIFICATIONS (units : mm)

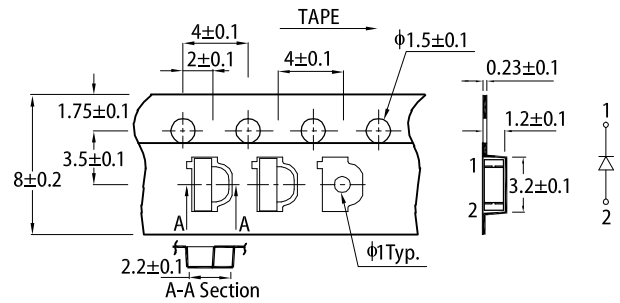

#### REEL DIMENSION (units : mm)

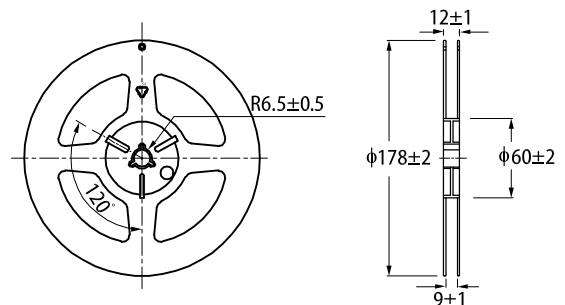

- Notes:
1. Don't cause stress to the LEDs while it is exposed to high temperature.
  2. The maximum number of reflow soldering passes is 2 times.
  3. Reflow soldering is recommended. Other soldering methods are not recommended as they might cause damage to the product.

### PACKING & LABEL SPECIFICATIONS

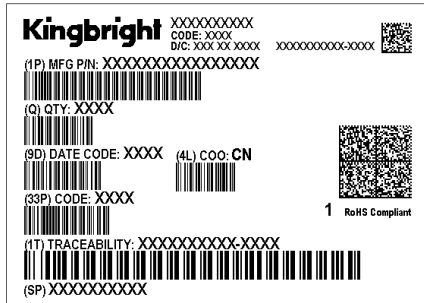
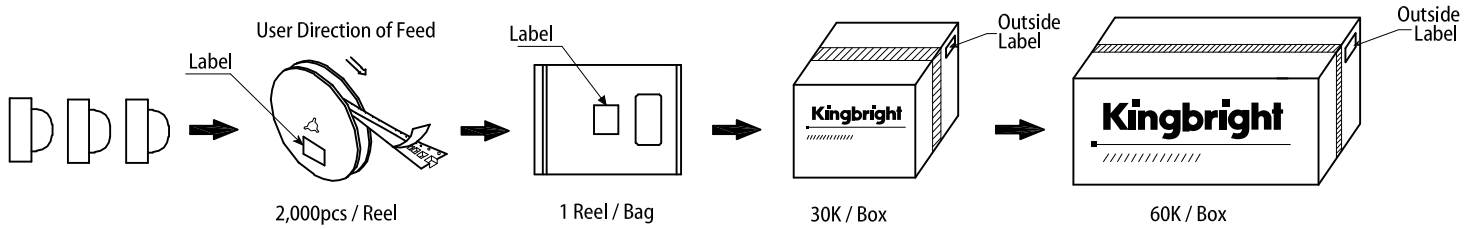

#### PRECAUTIONARY NOTES

1. The information included in this document reflects representative usage scenarios and is intended for technical reference only.
2. The part number, type, and specifications mentioned in this document are subject to future change and improvement without notice. Before production usage customer should refer to the latest datasheet for the updated specifications.
3. When using the products referenced in this document, please make sure the product is being operated within the environmental and electrical limits specified in the datasheet. If customer usage exceeds the specified limits, Kingbright will not be responsible for any subsequent issues.
4. The information in this document applies to typical usage in consumer electronics applications. If customer's application has special reliability requirements or have life-threatening liabilities, such as automotive or medical usage, please consult with Kingbright representative for further assistance.
5. The contents and information of this document may not be reproduced or re-transmitted without permission by Kingbright.
6. All design applications should refer to Kingbright application notes available at <https://www.KingbrightUSA.com/ApplicationNotes>

## Looking for pricing, stock, or lifecycle information?

Click below to explore more details on WIN SOURCE:

 [View APA3010F3C-GX on WIN SOURCE](#)

 [Kingbright Information](#)

## Optimize Your Supply Chain with WIN SOURCE Solutions

-  Global Sourcing Solution
-  Obsolete Management
-  Cost Control Management
-  Shortage Management
-  Alternative Solution
-  Excess Inventory Management