



**THE DATASHEET OF  
APT106N60LC6**





### Super Junction MOSFET

APT106N60B2C6

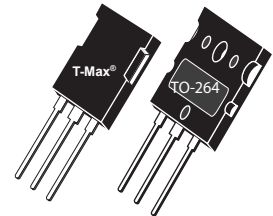

APT106N60LC6

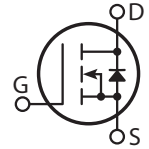

- Ultra Low  $R_{DS(ON)}$
- Low Miller Capacitance
- Ultra Low Gate Charge,  $Q_g$
- Avalanche Energy Rated
- Extreme  $dv/dt$  Rated
- Dual die (parallel)
- Popular T-MAX and TO-264 Packages

Unless stated otherwise, Microsemi discrete MOSFETs contain a single MOSFET die. This device is made with two parallel MOSFET die. It is intended for switch-mode operation. It is not suitable for linear mode operation.

#### MAXIMUM RATINGS

All Ratings per die:  $T_C = 25^\circ\text{C}$  unless otherwise specified.

Symbol	Parameter	APT106N60B2_LC6	UNIT
$V_{DSS}$	Drain-Source Voltage	600	Volts
$I_D$	Continuous Drain Current @ $T_C = 25^\circ\text{C}$ ①	106	Amps
	Continuous Drain Current @ $T_C = 100^\circ\text{C}$	68	
$I_{DM}$	Pulsed Drain Current ②	318	
$V_{GS}$	Gate-Source Voltage Continuous	$\pm 20$	Volts
$P_D$	Total Power Dissipation @ $T_C = 25^\circ\text{C}$	833	Watts
$T_J, T_{STG}$	Operating and Storage Junction Temperature Range	-55 - to 150	$^\circ\text{C}$
$T_L$	Lead Temperature: 0.063" from Case for 10 Sec.	260	
$I_{AR}$	Avalanche Current ②	18.6	Amps
$E_{AR}$	Repetitive Avalanche Energy ③ ( $I_D = 18.6\text{A}, V_{DD} = 50\text{V}$ )	3.4	
$E_{AS}$	Single Pulse Avalanche Energy ( $I_D = 18.6\text{A}, V_{DD} = 50\text{V}$ )	2200	mJ

#### STATIC ELECTRICAL CHARACTERISTICS

Symbol	Characteristic / Test Conditions	MIN	TYP	MAX	UNIT
$BV_{(DSS)}$	Drain-Source Breakdown Voltage ( $V_{GS} = 0\text{V}, I_D = 500\mu\text{A}$ )	650			Volts
$R_{DS(on)}$	Drain-Source On-State Resistance ④ ( $V_{GS} = 10\text{V}, I_D = 53\text{A}$ )			0.035	Ohms
$I_{DSS}$	Zero Gate Voltage Drain Current ( $V_{DS} = 600\text{V}, V_{GS} = 0\text{V}$ )			50	$\mu\text{A}$
	Zero Gate Voltage Drain Current ( $V_{DS} = 600\text{V}, V_{GS} = 0\text{V}, T_C = 150^\circ\text{C}$ )			500	
$I_{GSS}$	Gate-Source Leakage Current ( $V_{GS} = \pm 20\text{V}, V_{DS} = 0\text{V}$ )			$\pm 200$	nA
$V_{GS(th)}$	Gate Threshold Voltage ( $V_{DS} = V_{GS}, I_D = 3.4\text{mA}$ )	2.5	3	3.5	Volts

 CAUTION: These Devices are Sensitive to Electrostatic Discharge. Proper Handling Procedures Should Be Followed.

"COOLMOS™" comprise a new family of transistors developed by Infineon Technologies AG. "COOLMOS" is a trademark of Infineon Technologies AG."

Microsemi Website - <http://www.microsemi.com>

**DYNAMIC CHARACTERISTICS**

**APT106N60B2\_LC6**

Symbol	Characteristic	Test Conditions	MIN	TYP	MAX	UNIT
C <sub>iss</sub>	Input Capacitance	V <sub>GS</sub> = 0V V <sub>DS</sub> = 25V f = 1 MHz		8390		pF
C <sub>oss</sub>	Output Capacitance			7115		
C <sub>rss</sub>	Reverse Transfer Capacitance			229		
Q <sub>g</sub>	Total Gate Charge <sup>⑤</sup>	V <sub>GS</sub> = 10V V <sub>DD</sub> = 300V I <sub>D</sub> = 106A @ 25°C		308		nC
Q <sub>gs</sub>	Gate-Source Charge			50		
Q <sub>gd</sub>	Gate-Drain ("Miller") Charge			160		
t <sub>d(on)</sub>	Turn-on Delay Time	<b>INDUCTIVE SWITCHING</b> V <sub>GS</sub> = 15V V <sub>DD</sub> = 400V I <sub>D</sub> = 106A @ 25°C R <sub>G</sub> = 4.3Ω		25		ns
t <sub>r</sub>	Rise Time			79		
t <sub>d(off)</sub>	Turn-off Delay Time			277		
t <sub>f</sub>	Fall Time			164		
E <sub>on</sub>	Turn-on Switching Energy <sup>⑥</sup>	<b>INDUCTIVE SWITCHING @ 25°C</b> V <sub>DD</sub> = 400V, V <sub>GS</sub> = 15V I <sub>D</sub> = 106A, R <sub>G</sub> = 4.3Ω		2995		μJ
E <sub>off</sub>	Turn-off Switching Energy			3775		
E <sub>on</sub>	Turn-on Switching Energy <sup>⑥</sup>	<b>INDUCTIVE SWITCHING @ 125°C</b> V <sub>DD</sub> = 400V, V <sub>GS</sub> = 15V I <sub>D</sub> = 106A, R <sub>G</sub> = 4.3Ω		4055		
E <sub>off</sub>	Turn-off Switching Energy			4200		

**SOURCE-DRAIN DIODE RATINGS AND CHARACTERISTICS**

Symbol	Characteristic / Test Conditions	MIN	TYP	MAX	UNIT
I <sub>S</sub>	Continuous Source Current (Body Diode)			92	Amps
I <sub>SM</sub>	Pulsed Source Current <sup>②</sup> (Body Diode)			318	
V <sub>SD</sub>	Diode Forward Voltage <sup>④</sup> (V <sub>GS</sub> = 0V, I <sub>S</sub> = -106A)		0.9	1.2	Volts
dv/dt	Peak Diode Recovery <sup>⑦</sup> dv/dt			15	V/ns
t <sub>rr</sub>	Reverse Recovery Time (I <sub>S</sub> = -106A, di/dt = 100A/μs) T <sub>J</sub> = 25°C		1400		ns
Q <sub>rr</sub>	Reverse Recovery Charge (I <sub>S</sub> = -106A, di/dt = 100A/μs) T <sub>J</sub> = 25°C		45		μC
I <sub>RRM</sub>	Peak Recovery Current (I <sub>S</sub> = -106A, di/dt = 100A/μs) T <sub>J</sub> = 25°C		47		Amps

**THERMAL AND MECHANICAL CHARACTERISTICS**

Symbol	Characteristic	MIN	TYP	MAX	UNIT
R <sub>θJC</sub>	Junction to Case			0.15	°C/W
R <sub>θJA</sub>	Junction to Ambient			40	
W <sub>T</sub>	Package Weight		0.22		oz
			6.2		g
Torque	Mounting Torque (TO-264 Package), 4-40 or M3 screw			10	in·lbf
				1.1	N·m

- 1 Continuous current limited by package lead temperature.
- 2 Repetitive Rating: Pulse width limited by maximum junction temperature
- 3 Repetitive avalanche causes additional power losses that can be calculated as P<sub>AV</sub> = E<sub>AR</sub>\*f. Pulse width tp limited by T<sub>J</sub> max.
- 4 Pulse Test: P
- 5 See MIL-STD-750 Method 3471
- 6 Eon includes diode reverse recovery.
- 7 Maximum 125°C diode commutation speed = di/dt 600A/μs

Microsemi reserves the right to change, without notice, the specifications and information contained herein.

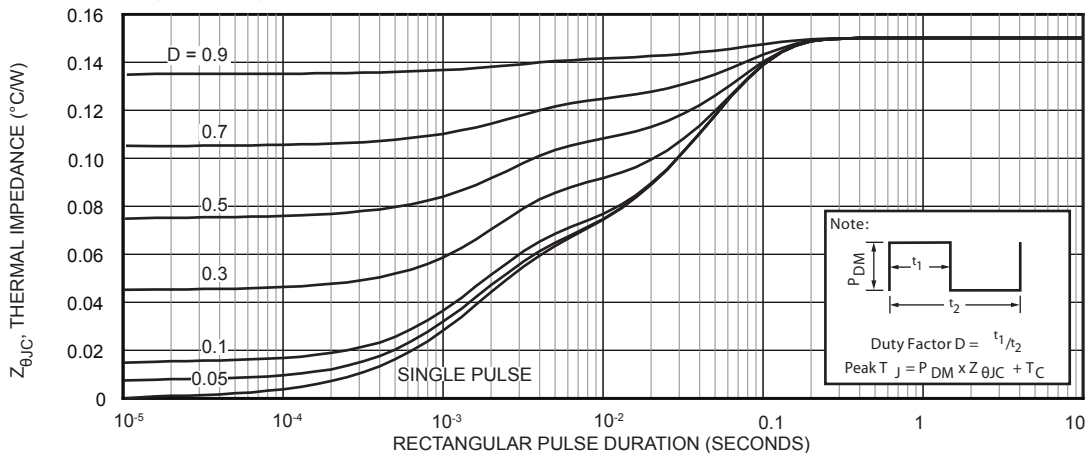

**FIGURE 1, Maximum Effective Transient Thermal Impedance, Junction-To-Case vs Pulse Duration**

**TYPICAL PERFORMANCE CURVES**

**APT106N60B2\_LC6**

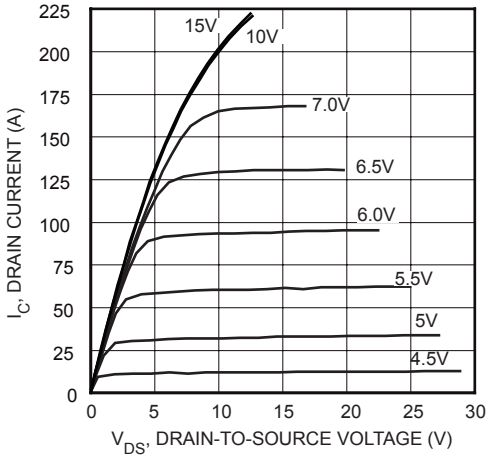

**FIGURE 2, Low Voltage Output Characteristics**

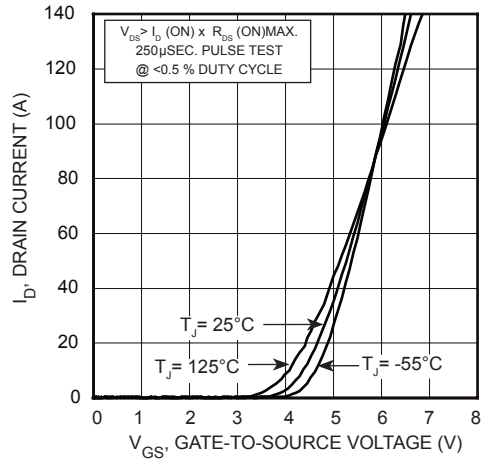

**FIGURE 3, Transfer Characteristics**

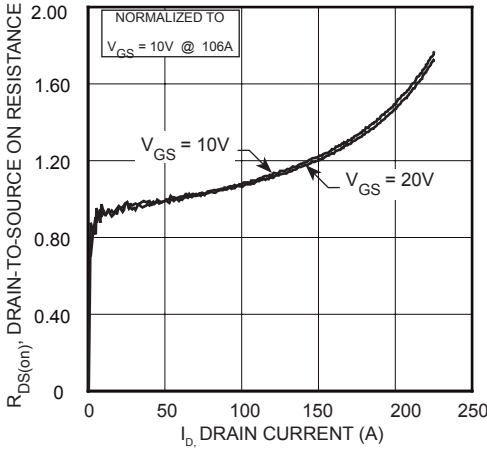

**FIGURE 4,  $R_{DS(ON)}$  vs Drain Current**

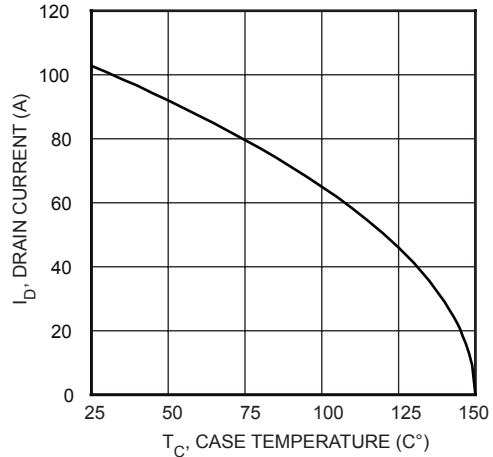

**FIGURE 5, Maximum Drain Current vs Case Temperature**

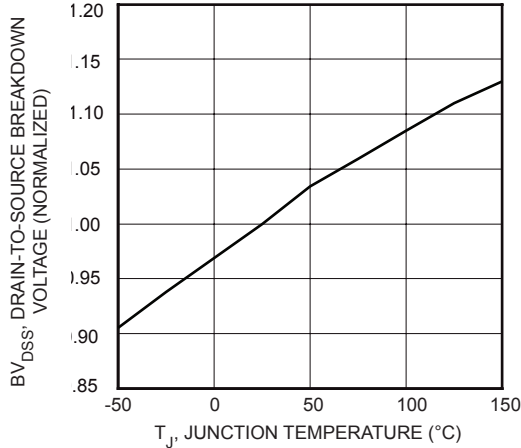

**FIGURE 6, Breakdown Voltage vs Temperature**

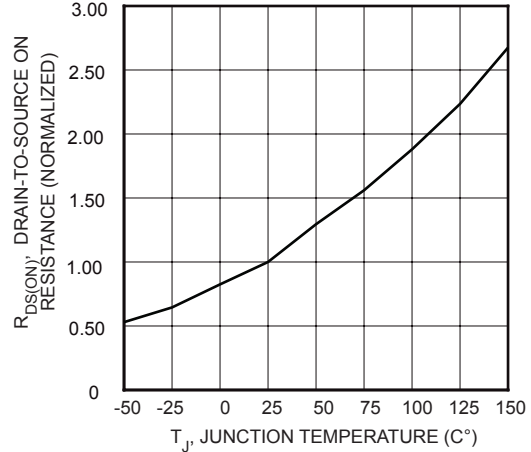

**FIGURE 7, On-Resistance vs Temperature**

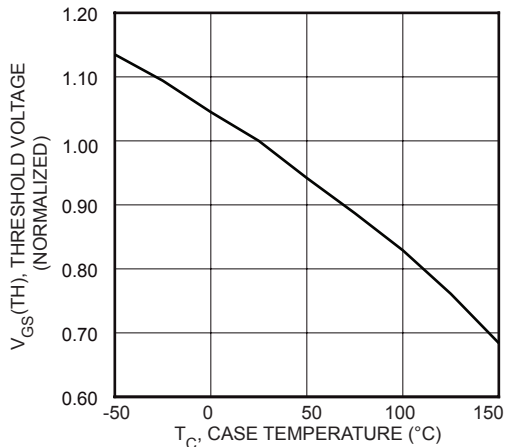

**FIGURE 8, Threshold Voltage vs Temperature**

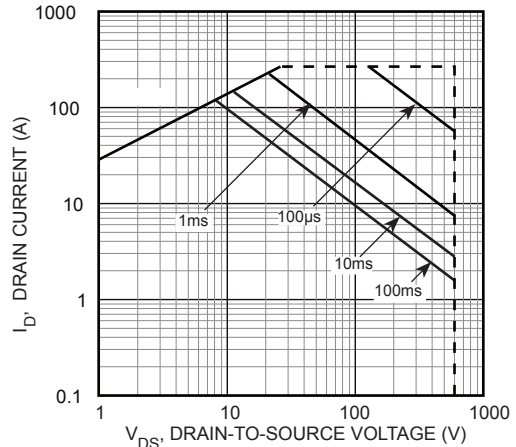

**FIGURE 9, Maximum Safe Operating Area**

# TYPICAL PERFORMANCE CURVES

APT106N60B2\_LC6

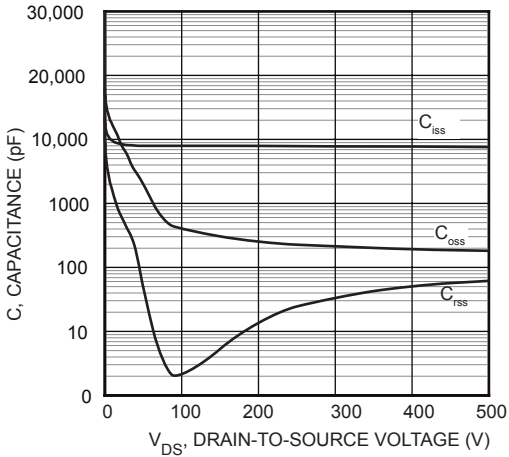

FIGURE 10, Capacitance vs Drain-To-Source Voltage

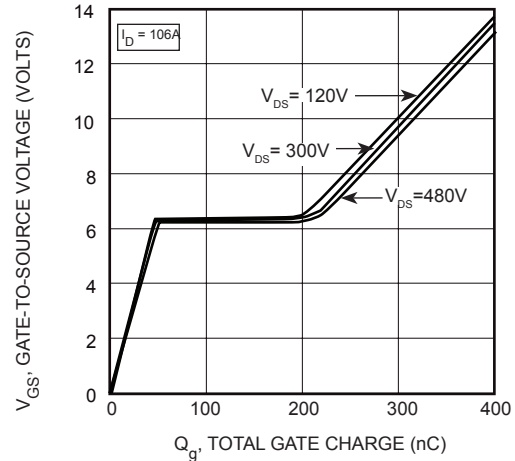

FIGURE 11, Gate Charges vs Gate-To-Source Voltage

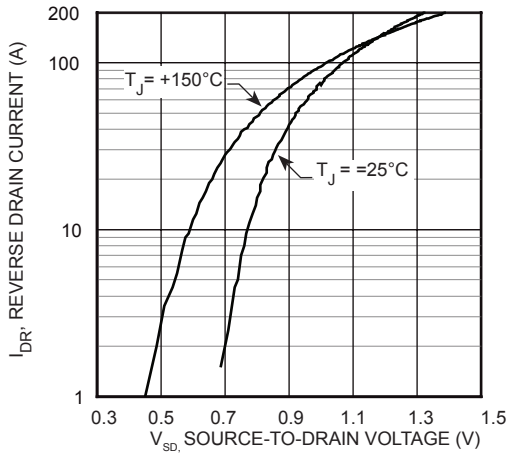

FIGURE 12, Source-Drain Diode Forward Voltage

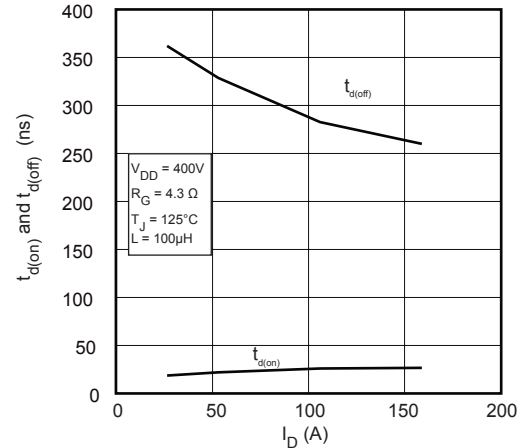

FIGURE 13, Delay Times vs Current

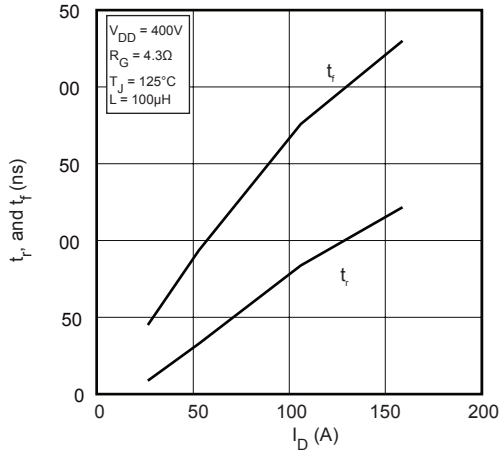

FIGURE 14, Rise and Fall Times vs Current

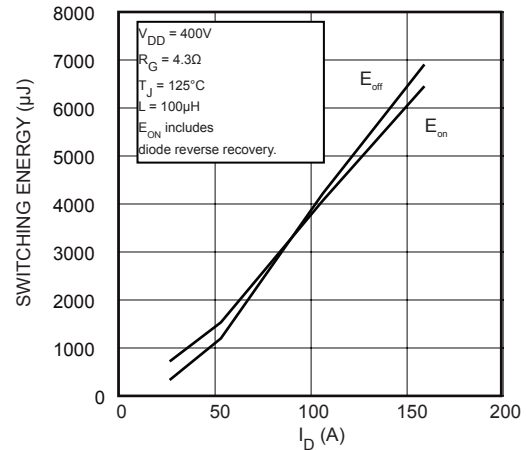

FIGURE 15, Switching Energy vs Current

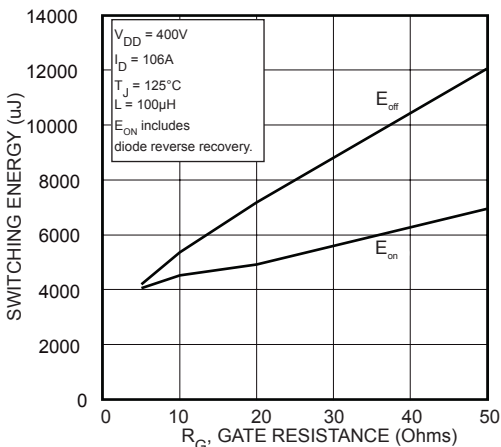

FIGURE 16, Switching Energy vs Gate Resistance

# TYPICAL PERFORMANCE CURVES

# APT106N60B2\_LC6

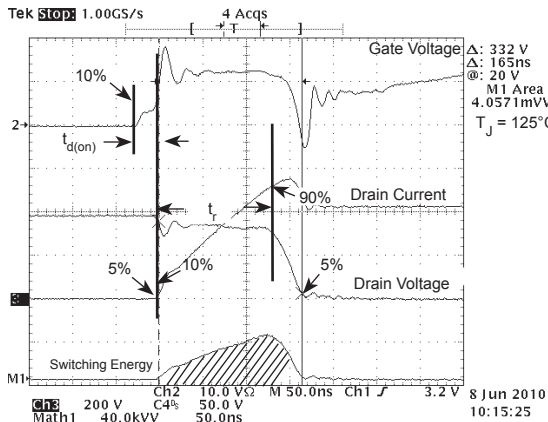

FIGURE 17, Turn-on Switching Waveforms and Definitions

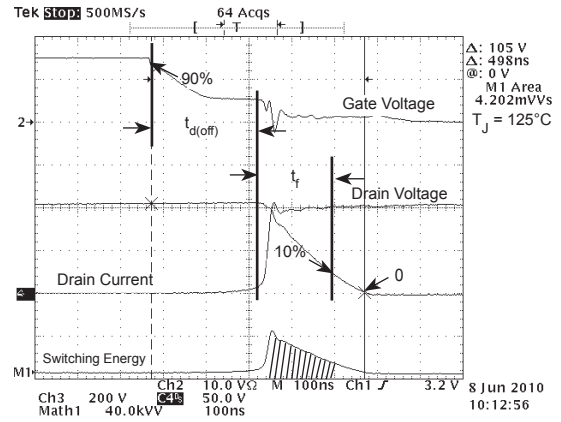

FIGURE 18, Turn-off Switching Waveforms and Definitions

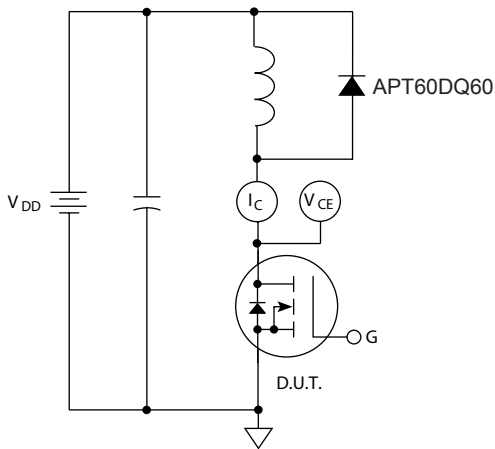
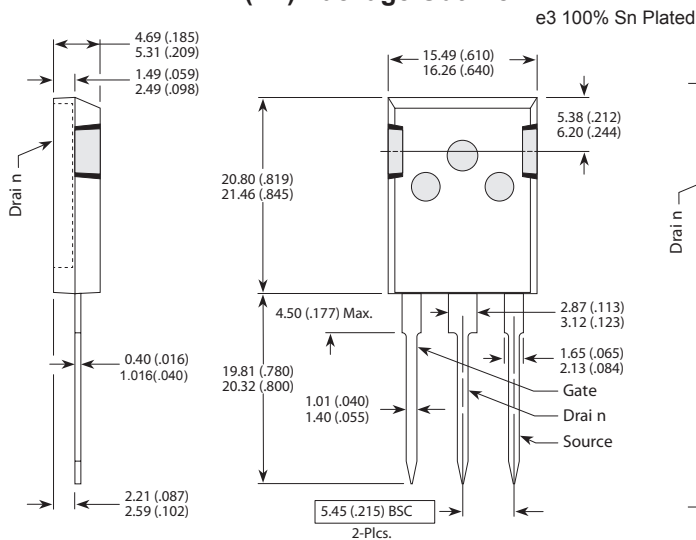

FIGURE 19, Inductive Switching Test Circuit

## T-MAX<sup>®</sup> (B2) Package Outline



These dimensions are equal to the TO-247 without the mounting hole.  
Dimensions in Millimeters and (Inches)

## TO-264 (L) Package Outline

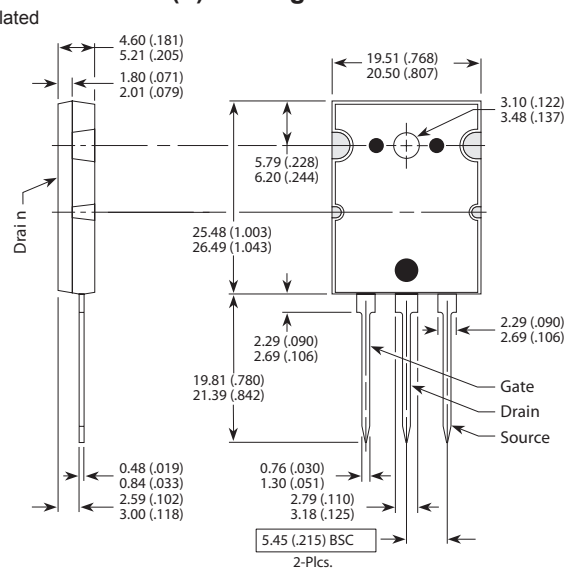

Dimensions in Millimeters and (Inches)

**Disclaimer:**

The information contained in the document (unless it is publicly available on the Web without access restrictions) is PROPRIETARY AND CONFIDENTIAL information of Microsemi and cannot be copied, published, uploaded, posted, transmitted, distributed or disclosed or used without the express duly signed written consent of Microsemi. If the recipient of this document has entered into a disclosure agreement with Microsemi, then the terms of such Agreement will also apply. This document and the information contained herein may not be modified, by any person other than authorized personnel of Microsemi. No license under any patent, copyright, trade secret or other intellectual property right is granted to or conferred upon you by disclosure or delivery of the information, either expressly, by implication, inducement, estoppels or otherwise. Any license under such intellectual property rights must be approved by Microsemi in writing signed by an officer of Microsemi.

Microsemi reserves the right to change the configuration, functionality and performance of its products at anytime without any notice. This product has been subject to limited testing and should not be used in conjunction with life-support or other mission-critical equipment or applications. Microsemi assumes no liability whatsoever, and Microsemi disclaims any express or implied warranty, relating to sale and/or use of Microsemi products including liability or warranties relating to fitness for a particular purpose, merchantability, or infringement of any patent, copyright or other intellectual property right. Any performance specifications believed to be reliable but are not verified and customer or user must conduct and complete all performance and other testing of this product as well as any user or customer's final application. User or customer shall not rely on any data and performance specifications or parameters provided by Microsemi. It is the customer's and user's responsibility to independently determine suitability of any Microsemi product and to test and verify the same. The information contained herein is provided "AS IS, WHERE IS" and with all faults, and the entire risk associated with such information is entirely with the User. Microsemi specifically disclaims any liability of any kind including for consequential, incidental and punitive damages as well as lost profit. The product is subject to other terms and conditions which can be located on the web at <http://www.microsemi.com/terms-a-conditions>.

## Looking for pricing, stock, or lifecycle information?

Click below to explore more details on WIN SOURCE:

 [View APT106N60LC6 on WIN SOURCE](#)

 [Microchip Technology](#) Information

## Optimize Your Supply Chain with WIN SOURCE Solutions

-  Global Sourcing Solution
-  Obsolete Management
-  Cost Control Management
-  Shortage Management
-  Alternative Solution
-  Excess Inventory Management