



**THE DATASHEET OF
APT77N60JC3**



Super Junction MOSFET

- Ultra Low $R_{DS(ON)}$
- Low Miller Capacitance
- Ultra Low Gate Charge, Q_g
- Avalanche Energy Rated
- Extreme dv/dt Rated
- Dual die (parallel)

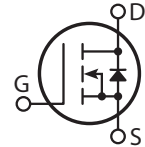
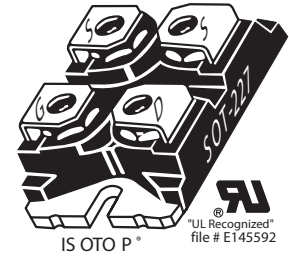

Unless stated otherwise, Microsemi discrete MOSFETs contain a single MOSFET die. This device is made with two parallel MOSFET die. It is intended for switch-mode operation. It is not suitable for linear mode operation.

MAXIMUM RATINGS

All Ratings per die: $T_C = 25^\circ\text{C}$ unless otherwise specified.

Symbol	Parameter	APT77N60JC3	UNIT
V_{DSS}	Drain-Source Voltage	600	Volts
I_D	Continuous Drain Current @ $T_C = 25^\circ\text{C}$ ①	77	Amps
I_{DM}	Pulsed Drain Current ②	231	
V_{GS}	Gate-Source Voltage Continuous	± 20	Volts
V_{GSM}	Gate-Source Voltage Transient	± 30	
P_D	Total Power Dissipation @ $T_C = 25^\circ\text{C}$	568	Watts
	Linear Derating Factor	4.55	W/ $^\circ\text{C}$
T_J, T_{STG}	Operating and Storage Junction Temperature Range	-55 - to 150	$^\circ\text{C}$
T_L	Lead Temperature: 0.063" from Case for 10 Sec.	300	
dv/dt	Drain-Source Voltage slope ($V_{DS} = 400\text{V}$, $I_D = 77\text{A}$, $T_J = 125^\circ\text{C}$)	50	V/ns
I_{AR}	Avalanche Current ②	20	Amps
E_{AR}	Repetitive Avalanche Energy ③	1	mJ
E_{AS}	Single Pulse Avalanche Energy	180	

STATIC ELECTRICAL CHARACTERISTICS

Symbol	Characteristic / Test Conditions	MIN	TYP	MAX	UNIT
$BV_{(DSS)}$	Drain-Source Breakdown Voltage ($V_{GS} = 0\text{V}$, $I_D = 500\mu\text{A}$)	600			Volts
$R_{DS(on)}$	Drain-Source On-State Resistance ⁴ ($V_{GS} = 10\text{V}$, $I_D = 70\text{A}$)		.030	0.035	Ohms
I_{DSS}	Zero Gate Voltage Drain Current ($V_{DS} = 650\text{V}$, $V_{GS} = 0\text{V}$)		1.0	50	μA
	Zero Gate Voltage Drain Current ($V_{DS} = 650\text{V}$, $V_{GS} = 0\text{V}$, $T_C = 150^\circ\text{C}$)			500	
I_{GSS}	Gate-Source Leakage Current ($V_{GS} = \pm 20\text{V}$, $V_{DS} = 0\text{V}$)			± 200	nA
$V_{GS(th)}$	Gate Threshold Voltage ($V_{DS} = V_{GS}$, $I_D = 5.92\text{mA}$)	2.1	3	3.9	Volts

CAUTION: These Devices are Sensitive to Electrostatic Discharge. Proper Handling Procedures Should Be Followed.

"COOLMOS™" comprise a new family of transistors developed by Infineon Technologies AG. "COOLMOS" is a trademark of Infineon Technologies AG"

DYNAMIC CHARACTERISTICS

APT77N60JC3

Symbol	Characteristic	Test Conditions	MIN	TYP	MAX	UNIT
C _{iss}	Input Capacitance	V _{GS} = 0V V _{DS} = 25V f = 1 MHz		13600		pF
C _{oss}	Output Capacitance			4400		
C _{rss}	Reverse Transfer Capacitance			290		
Q _g	Total Gate Charge ^③	V _{GS} = 10V V _{DD} = 300V I _D = 77A @ 25°C		505	640	nC
Q _{gs}	Gate-Source Charge			48		
Q _{gd}	Gate-Drain ("Miller") Charge			240		
t _{d(on)}	Turn-on Delay Time	RESISTIVE SWITCHING V _{GS} = 10V V _{DD} = 380V I _D = 77A @ 125°C R _G = 0.9Ω		18		ns
t _r	Rise Time			27		
t _{d(off)}	Turn-off Delay Time			110	165	
t _f	Fall Time			8	12	
E _{on}	Turn-on Switching Energy ^⑥	INDUCTIVE SWITCHING @ 25°C V _{DD} = 400V, V _{GS} = 15V I _D = 77A, R _G = 5Ω		1670		μJ
E _{off}	Turn-off Switching Energy			2880		
E _{on}	Turn-on Switching Energy ^⑥	INDUCTIVE SWITCHING @ 125°C V _{DD} = 400V, V _{GS} = 15V I _D = 77A, R _G = 5Ω		2300		
E _{off}	Turn-off Switching Energy			3100		

SOURCE-DRAIN DIODE RATINGS AND CHARACTERISTICS

Symbol	Characteristic / Test Conditions	MIN	TYP	MAX	UNIT
I _S	Continuous Source Current (Body Diode)			77	Amps
I _{SM}	Pulsed Source Current ^① (Body Diode)			231	
V _{SD}	Diode Forward Voltage ^② (V _{GS} = 0V, I _S = -77A)		1	1.2	Volts
t _{rr}	Reverse Recovery Time (I _S = -77A, di _S /dt = 100A/μs, V _R = 350V)		861		ns
Q _{rr}	Reverse Recovery Charge (I _S = -77A, di _S /dt = 100A/μs, V _R = 350V)		46		μC
dv _J /dt	Peak Diode Recovery dv _J /dt ^⑤			6	V/ns

THERMAL CHARACTERISTICS

Symbol	Characteristic	MIN	TYP	MAX	UNIT
R _{θJC}	Junction to Case			0.22	°C/W
R _{θJA}	Junction to Ambient			40	

① Repetitive Rating: Pulse width limited by maximum junction temperature

② Pulse Test: Pulse width < 380 μs, Duty Cycle < 2%

③ See MIL-STD-750 Method 3471

④ Starting T_J = +25°C, L = 36.0mH, R_G = 25Ω, Peak I_L = 10A

⑤ dv_J/dt numbers reflect the limitations of the test circuit rather than the device itself. I_S ≤ -I_D 77A di_J/dt ≤ 700A/μs V_R ≤ V_{DSS} T_J ≤ 150°C

⑥ Eon includes diode reverse recovery. See figures 18, 20.

⑦ Repetitive avalanche causes additional power losses that can be calculated as P_{AV} = E_{AR} * f

Microsemi reserves the right to change, without notice, the specifications and information contained herein.

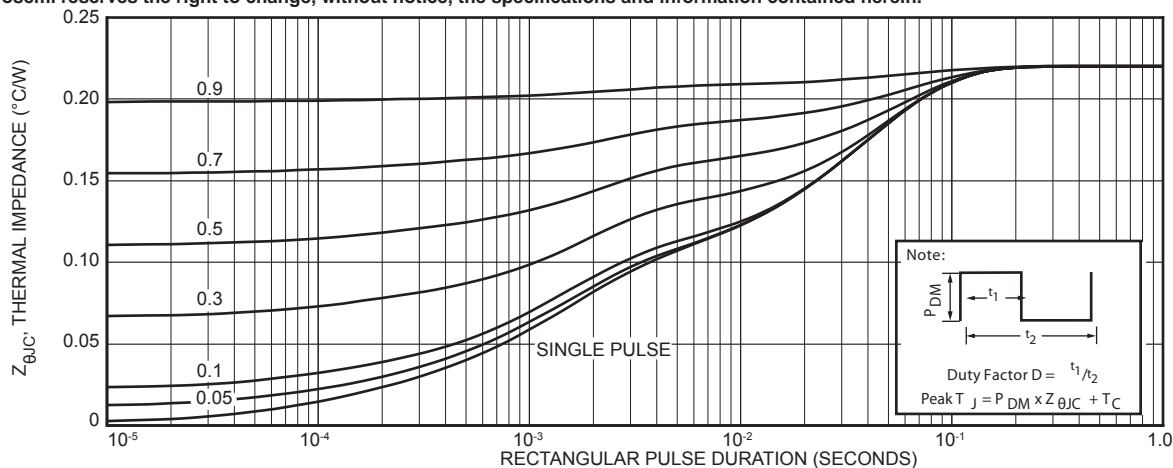

FIGURE 1, MAXIMUM EFFECTIVE TRANSIENT THERMAL IMPEDANCE, JUNCTION-TO-CASE vs PULSE DURATION

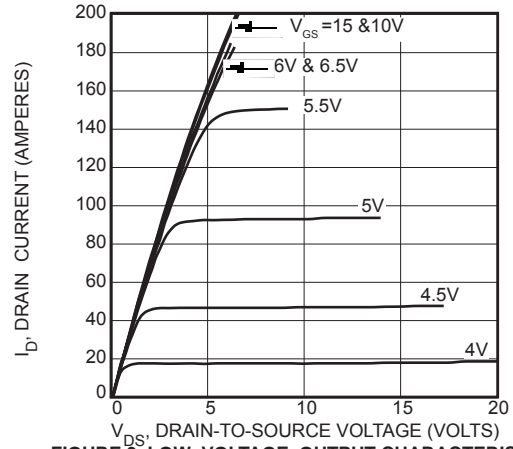

FIGURE 3, LOW VOLTAGE OUTPUT CHARACTERISTICS

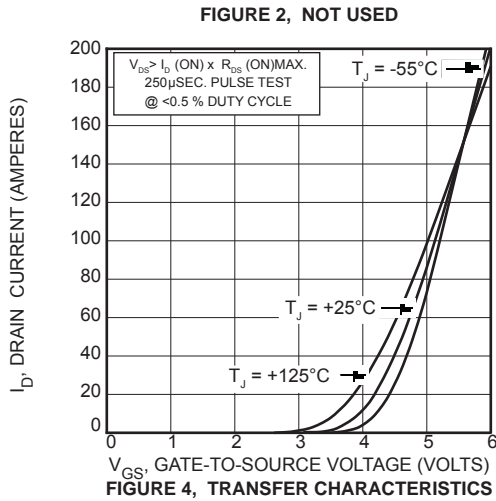

FIGURE 4, TRANSFER CHARACTERISTICS

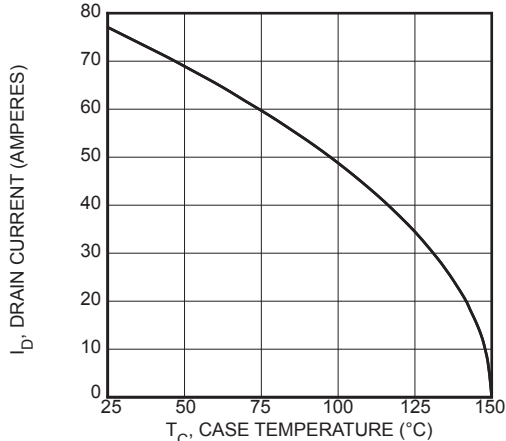

FIGURE 6, MAXIMUM DRAIN CURRENT vs CASE TEMPERATURE

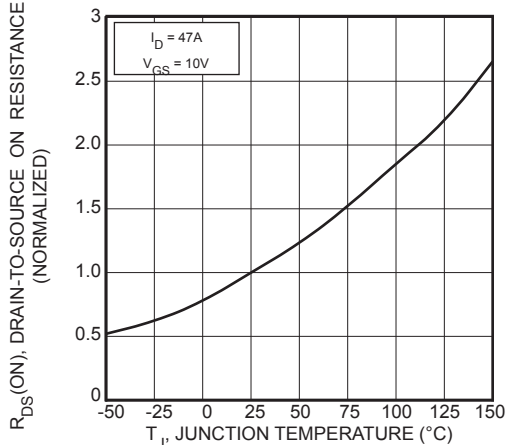

FIGURE 8, ON-RESISTANCE vs. TEMPERATURE

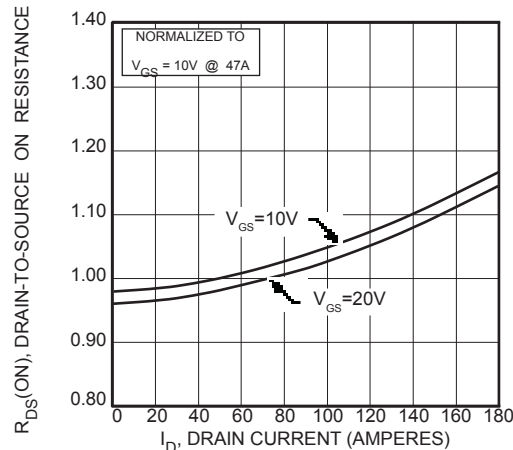

FIGURE 5, $R_{DS(ON)}$ vs DRAIN CURRENT

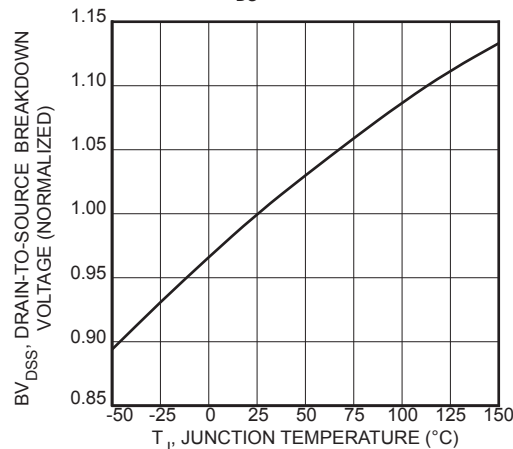

FIGURE 7, BREAKDOWN VOLTAGE vs TEMPERATURE

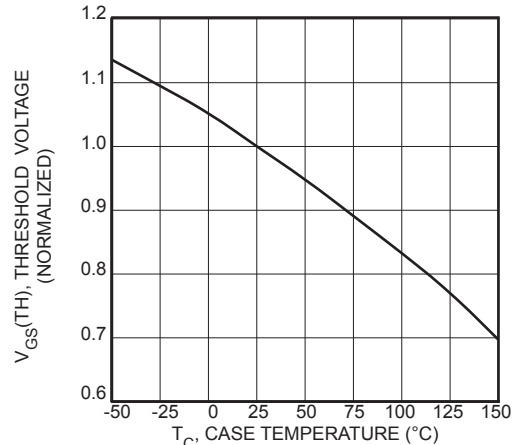

FIGURE 9, THRESHOLD VOLTAGE vs TEMPERATURE

Typical Performance

APT77N60JC3

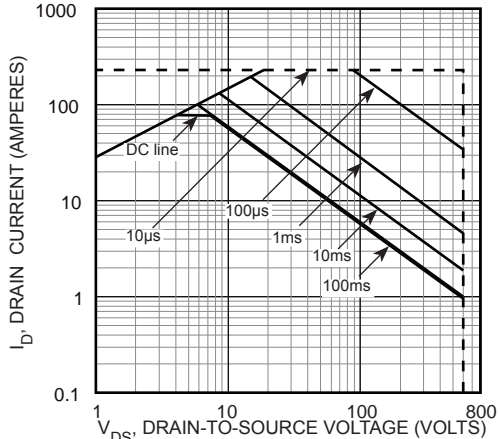

FIGURE 10, MAXIMUM SAFE OPERATING AREA

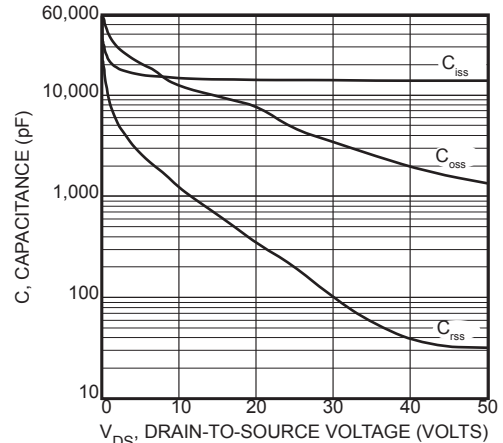

FIGURE 11, CAPACITANCE vs DRAIN-TO-SOURCE VOLTAGE

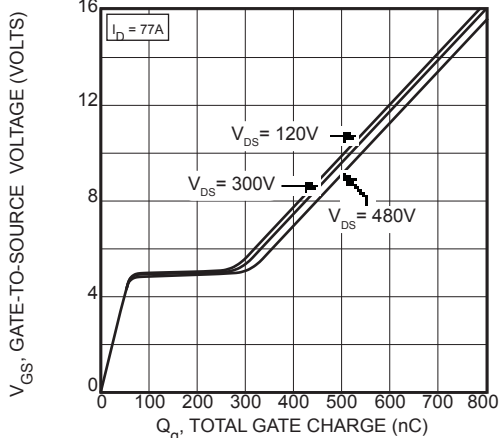

FIGURE 12, GATE CHARGES vs GATE-TO-SOURCE VOLTAGE

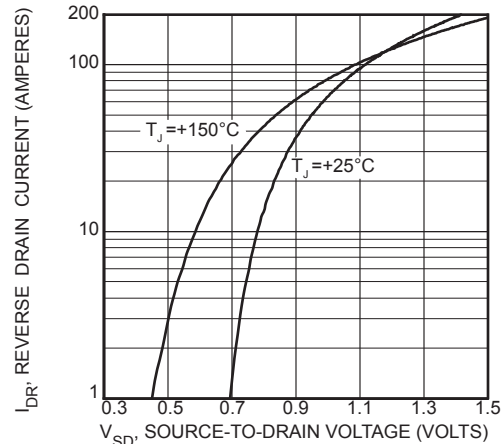

FIGURE 13, SOURCE-DRAIN DIODE FORWARD VOLTAGE

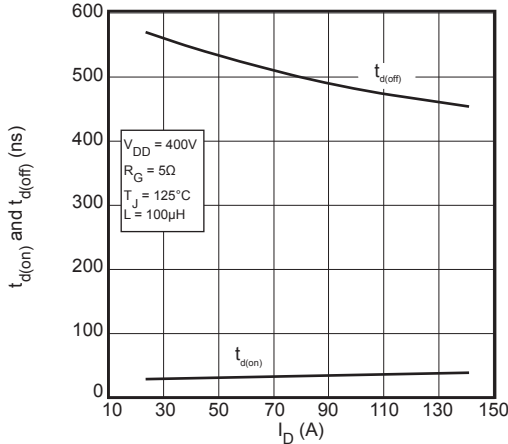

FIGURE 14, DELAY TIMES vs CURRENT

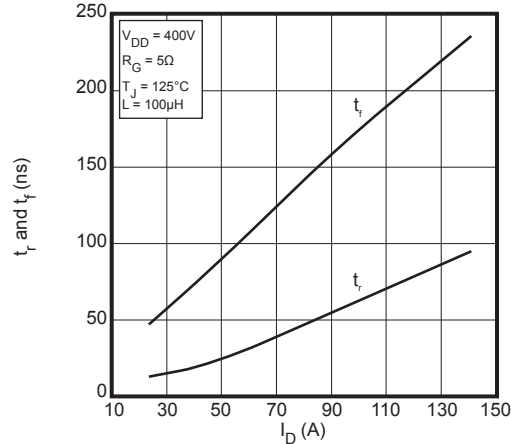

FIGURE 15, RISE AND FALL TIMES vs CURRENT

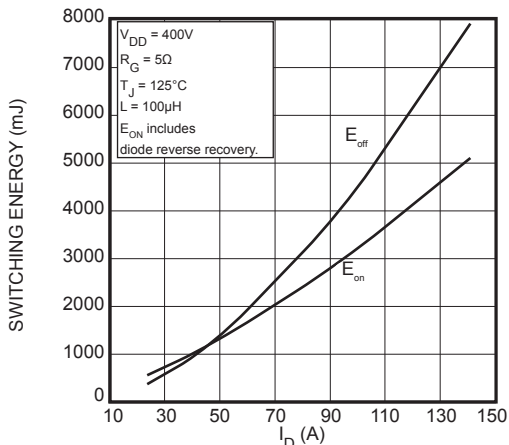

FIGURE 16, SWITCHING ENERGY vs CURRENT

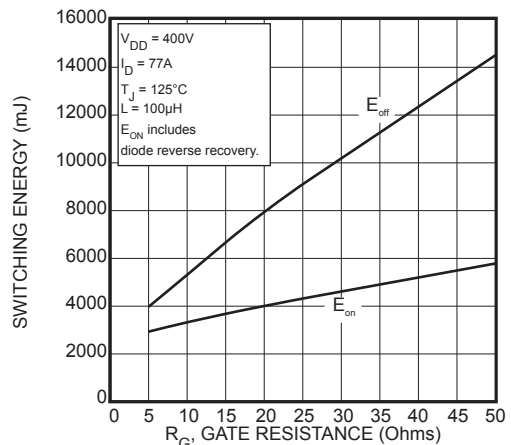

FIGURE 17, SWITCHING ENERGY vs. GATE RESISTANCE

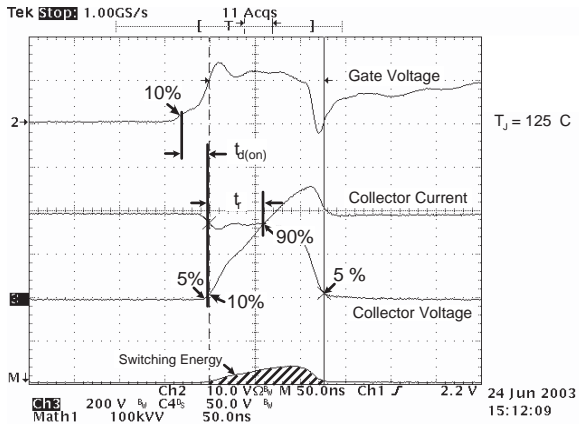

Figure 18, Turn-on Switching Waveforms and Definitions

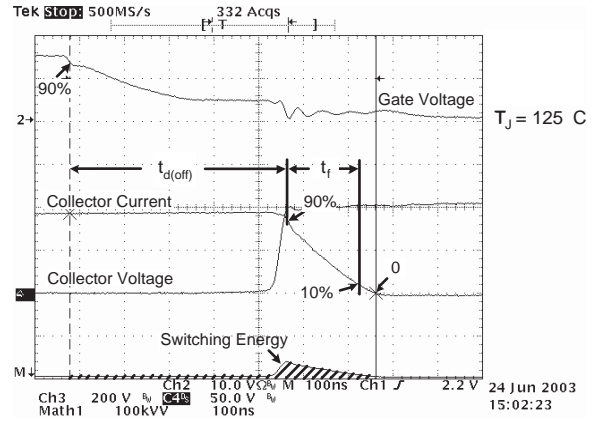

Figure 19, Turn-off Switching Waveforms and Definitions

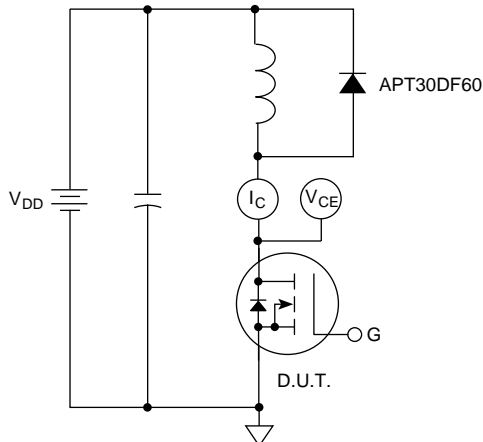
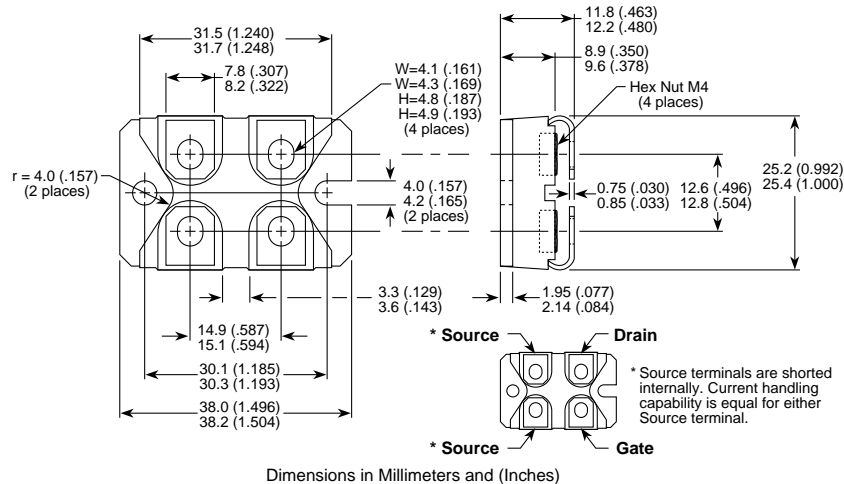

Figure 20, Inductive Switching Test Circuit

SOT-227 (ISOTOP®) Package Outline



Looking for pricing, stock, or lifecycle information?

Click below to explore more details on WIN SOURCE:

- ⊖ [View APT77N60JC3 on WIN SOURCE](#)
- ⊖ [Microchip Technology Information](#)

Optimize Your Supply Chain with WIN SOURCE Solutions

- ✓ Global Sourcing Solution
- ✓ Obsolete Management
- ✓ Cost Control Management
- ✓ Shortage Management
- ✓ Alternative Solution
- ✓ Excess Inventory Management