



**THE DATASHEET OF  
AZ2100-1C-24DEF**



# AZ2100

## MINIATURE POWER RELAY

### FEATURES

- 40 Amp switching capability
- 1 Form A, B and C contacts available
- Both PC and quick-connect terminals for contacts
- Life expectancy to 10 million operations
- Class F (155°C) version available
- Available with an epoxy seal for automatic wave soldering and immersion cleaning
- Proof Tracking Index (PTI/CTI) 175
- UL, CUR file E44211
- VDE certificate 40023154 (some models)



### CONTACTS

<b>Arrangement</b>	SPST-N.O. (1 Form A) SPST-N.C. (1 Form B) SPDT (1 Form C)
<b>Ratings (max.)</b> switched power switched current switched voltage	(resistive load) 900 W or 10000 VA 40 A (Form A), 30 A (Form B) 30VDC* or 300VAC  * Note: If switching voltage is greater than 30 VDC, special precautions must be taken. Please contact the factory.
<b>Rated Loads</b> UL/CUR  VDE	See pg.2 for UL/CUR approved contact ratings  <b>1 Form A - class F coil wire, AgCdO</b> 25 A at 250 VAC, 10k cycles, resistive <b>1 Form A - class B coil wire, AgCdO</b> 20 A at 250 VAC, 10k cycles, resistive <b>1 Form C, AgCdO</b> NO: 20 A at 250 VAC, 10k cycles, resistive NC: 10 A at 250 VAC, 10k cycles, resistive
<b>Contact materials</b>	AgSnO <sub>2</sub> (silver tin oxide) AgCdO (silver cadmium oxide)
<b>Contact resistance</b> initial	(load contact, voltage drop method) ≤ 50 mΩ

### COIL

<b>Nominal coil DC voltages</b>	5, 6, 9, 12, 15, 18, 24, 48, 70, 110
<b>Dropout voltage</b>	> 10% of nominal coil voltage
<b>Holding voltage</b>	> 35% of nominal coil voltage
<b>Coil power</b> nominal max. continuous  at pickup voltage	(at 23°C) 0.9 W 2.2 W at 20°C (68°F) ambient 1.8 W at 40°C (104°F) ambient 500 mW (typ.)
<b>Temperature Rise</b>	38 K (68°F) at nom. coil voltage
<b>Max. temperature</b>	130°C (266°F) - class B coil wire 155°C (311°F) - class F coil wire

### GENERAL DATA

<b>Life Expectancy</b> mechanical electrical	(minimum operations) 1 x 10 <sup>7</sup> 1 x 10 <sup>5</sup> at 30 A 125 VAC resistive (N.O.)
<b>Operate Time</b>	8 ms (typ.), 15 ms (max.) at nominal coil voltage
<b>Release Time</b>	3.5 ms (typ.), 10 ms (max.) at nominal coil voltage, w/o coil suppression
<b>Dielectric Strength</b> coil to load contacts open load contacts	(at sea level for 1 min.) 2500 V <sub>RMS</sub> 1500 V <sub>RMS</sub>
<b>Insulation Resistance</b>	1000 MΩ (min.) at 20°C, 500 VDC, 50% RH
<b>Temperature Range</b> operating	(at nominal coil voltage) -55°C (-67°F) to 85°C (185°F) - class B coil -55°C (-67°F) to 105°C (221°F) - class F coil
<b>Vibration resistance</b>	0.062" (1.5 mm) DA at 10–55 Hz
<b>Shock</b>	10 g
<b>Enclosure</b> flammability	P.B.T. polyester UL94 V-0
<b>Terminals</b>	Tinned copper alloy, P. C. on bottom with quick-connect tabs 0.250" on top Note: Allow suitable slack on leads when wiring, do not subject the QC terminals to excessive force
<b>Soldering</b> max. temperature max. time	270 °C (518°F) 5 s
<b>Cleaning</b> max. Solvent Temp. max. Immersion Time	80°C (176°F) 30 seconds
<b>Dimensions</b> length width height	32.23 mm (1.27") 27.4 mm (1.08") 27.9 mm (1.10")
<b>Weight</b>	35 grams (approx.)
<b>Compliance</b>	UL 508, IEC 61810-1

**ZETTLER**

# AZ2100

## UL/CUR APPROVED CONTACT RATINGS (AgCdO)

Load type	Cycles	Volts	Form A	Form B	Form C	
			N.O.	N.C.	N.O.	N.C.
General purpose (inductive)	100,000	240 VAC	30 A	15 A	30 A	15 A
	30,000	277 VAC	30 A	30 A	30 A	30 A
Resistive	100,000	240 VAC	30 A	15 A	-	-
	100,000	30 VDC	20 A	10 A	20 A	10A
	100,000	277 VAC	20 A	-	-	-
	100,000 <sup>1)</sup>	240 VAC	15 A	-	-	-
	30,000 <sup>1)</sup>	250 VAC	23 A	-	-	-
	25,000	240 VAC	20 A	10 A	20 A	10 A
	6,000	277 VAC	12 A	6 A	12 A	6 A
	6,000	250 VAC	40 A	-	40 A	-
Ballast	6,000	277 VAC	6 A	3 A	6 A	3 A
Pilot Duty	100,000	277 VAC	764 VA	-	764 VA	-
	100,000	125 VAC	690 VA	-	690 VA	-
	30,000	125 VAC	800 VA	-	800 VA	-
	6,000	240 VAC	1152 VA	768 VA	1152 VA	768 VA
	6,000	125 VAC	800 VA	290 VA	800 VA	290 VA
Motor Load	100,000	125 VAC	¾ HP	-	¾ HP	-
	100,000	277 VAC	¾ HP	-	¾ HP	-
	30,000	125 VAC	1 HP	-	1 HP	-
	6,000	125 VAC	1 HP	¼ HP	1 HP	¼ HP
	6,000	240 VAC	2 HP	1 HP	2 HP	2 HP
	6,000 <sup>3)</sup>	240 VAC	3 HP	-	-	-
Tungsten	6,000	120 VAC	5 A	3 A	5 A	3 A
	6,000	240 VAC	5 A	3 A	5 A	3 A
	6,000	125 VAC	15 A	-	15 A	-
TV-5	25,000	120 VAC	TV-5	-	TV-5	TV-3
TV-3	25,000	120 VAC	-	TV-3	-	TV-3
Definite Purpose	100,000	277 VAC	60 LRA 20 FLA	-	60 LRA 20 FLA	-
	100,000	125 VAC	82.8 LRA 27 FLA	-	82.8 LRA 27 FLA	-
	100,000 <sup>2)4)</sup>	240 VAC	75 LRA 15 FLA	-	-	-
	30,000	240 VAC	80 LRA 30 FLA	33 LRA 10 FLA	60 LRA 30 FLA	33 LRA 10 FLA
	30,000	125 VAC	96 LRA 30 FLA	33 LRA 10 FLA	60 LRA 30 FLA	33 LRA 10 FLA
	30,000 <sup>2)</sup>	240 VAC	60 LRA 20 FLA	-	60 LRA 20 FLA	-
	30,000 <sup>2)</sup>	125 VAC	60 LRA 20 FLA	30 LRA 12 FLA	60 LRA 20 FLA	30 LRA 12 FLA
	30,000 <sup>2)</sup>	120 VAC	82.8 LRA 13.8 FLA	-	82.8 LRA 13.8 FLA	-

### Notes to table UL/CUR APPROVED CONTACT RATINGS—AgCdO

- 1) Ambient temperature: 98°C max. for sealed version, 105°C max. for unsealed class F version (reduced contact load)
- 2) Ambient temperature: 85°C
- 3) Ambient temperature: 65°C
- 4) Tested per UL 60730-1A/CSA 60730-1A using 1 sec. On, 9 sec. Off at 0.4 to 0.5 power factor for overload test

## UL/CUR APPROVED CONTACT RATINGS (AgSnO2)

Load type	Cycles	Volts	Form A	Form B	Form C	
			N.O.	N.C.	N.O.	N.C.
General Use	100,000	125 VAC	30 A	15 A	30 A	15 A
	100,000	240 VAC	20 A	15 A	20 A	15 A
	30,000	277 VAC	30 A	30 A	30 A	30 A
	100,000	30 VDC	20 A	10 A	20 A	10 A
Resistive	6,000	250 VAC	40 A	-	-	-
	100,000 <sup>1)</sup>	240 VAC	30 A	-	-	-
	80,000 <sup>2)</sup>	240 VAC	20.3 A	-	20.3 A	-
	100,000 <sup>2)</sup>	240 VAC	18 A	-	18 A	-
	6,000 <sup>2)</sup>	240 VAC	-	17 A	-	17 A
Motor Load	6,000	250 VAC	1 HP	-	1 HP	1 HP

### Notes to table UL/CUR APPROVED CONTACT RATINGS—AgSnO

- 1) Ambient temperature: 70°C
- 2) Ambient temperature: 105°C

## ORDERING DATA

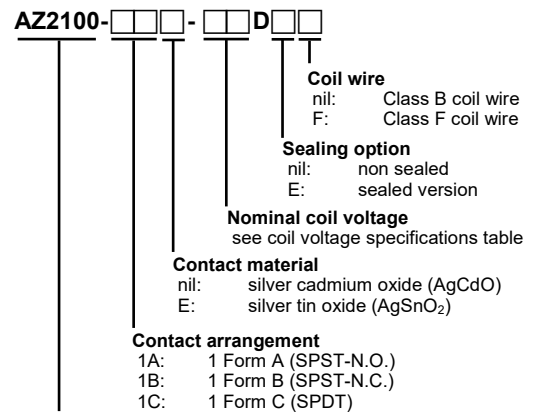

### Series

AZ2100: 1/8" Clearance, 1/4" Creepage meeting UL 508 Group A spacing and UL 873 refrigeration and safety control requirements.

AZ2101: Contact factory for availability & drawings

### Example ordering data

- AZ2100-1A-9D 4 PCB & 2 QC terminals, 1 Form A, AgCdO contacts, 9 VDC coil voltage, non sealed, class B coil wire
- AZ2100-1CE-24DEF 5 PCB & 3 QC terminals, 1 Form C, AgSnO<sub>2</sub> contacts, 24 VDC coil voltage, sealed, class F coil wire

# AZ2100

## COIL VOLTAGE SPECIFICATIONS

Nominal Coil VDC	Must Operate VDC	Max. Continuous VDC	Resistance Ohm $\pm 10\%$
5	3.75	7.3	27
6	4.5	8.9	40
9	6.75	13.9	97
12	9.0	17.5	155
15	11.25	22.5	256
18	13.5	27.4	380
24	18.0	36.1	660
48	36.0	68.4	2560
70	52.5	104.4	5500
110	82.5	163.2	13450

Note: All values at 23°C (73°F), upright position, terminals downward.

## COIL TEMPERATURE RISE

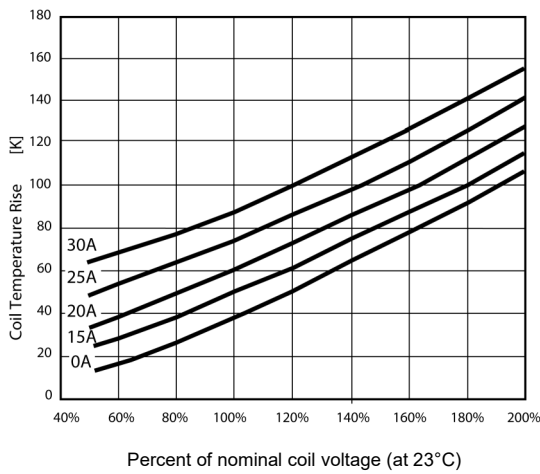

## NOTES

- All values at 23°C (73°F).
- Relay may pull in with less than "Must Operate" value.
- Provide sufficient PCB cross section as heat spreader on terminals.
- Specifications subject to change without notice.

## MECHANICAL DATA

Dimensions in inches with metric equivalents in parentheses. Tolerance:  $\pm .010"$

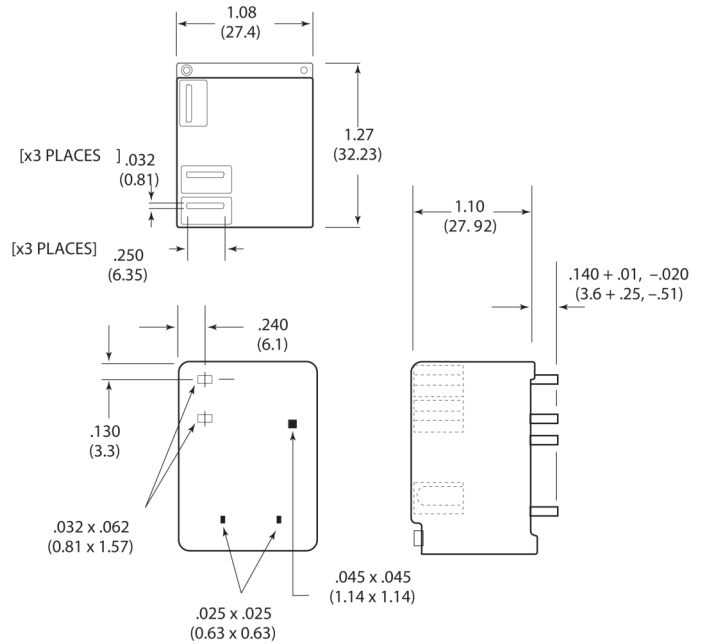

## PC BOARD LAYOUT

Dimensions in inches with metric equivalents in parentheses. Viewed towards terminals.

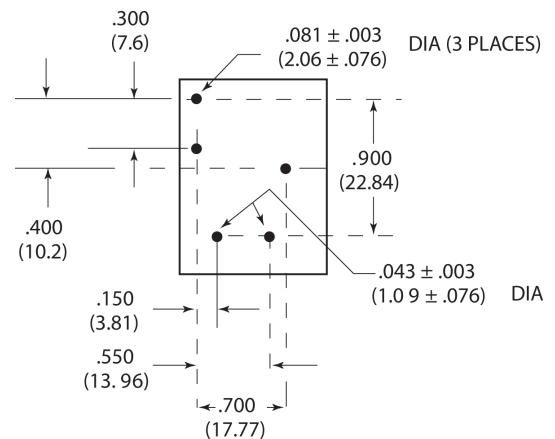

## WIRING DIAGRAMS

Viewed towards terminals

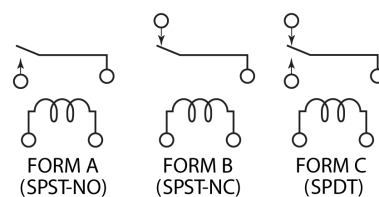

# AZ2100

## DISCLAIMER

This product specification is to be used in conjunction with the application notes which can be downloaded from the regional ZETTLER relay websites. The specification provides an overview of the most significant part features. Any individual applications and operating conditions are not taken into consideration. It is recommended to test the product under application conditions. Responsibility for the application remains with the customer. Proper operation and service life cannot be guaranteed if the part is operated outside the specified limits.

## ZETTLER GROUP

Building on a foundation of more than a century of expertise in German precision engineering, ZETTLER Group is a world-class enterprise, engaged in the design, manufacturing, sales and distribution of electronic components. Our industry leadership is based on a unique combination of engineering competence and global scale.

For more information on other ZETTLER Group companies, please visit [zettler-group.com](http://zettler-group.com). For support on this product or other ZETTLER relays, please visit one of the group sites below.

## SITES FOR ZETTLER RELAYS

### NORTH AMERICA

American Zettler, Inc.  
[www.azettler.com](http://www.azettler.com)  
[sales@azettler.com](mailto:sales@azettler.com)

### EUROPE

Zettler Electronics, GmbH  
[www.zettlerelectronics.com](http://www.zettlerelectronics.com)  
[office@zettlerelectronics.com](mailto:office@zettlerelectronics.com)

Zettler Electronics, Poland  
[www.zettlerelectronics.pl](http://www.zettlerelectronics.pl)  
[office@zettlerelectronics.pl](mailto:office@zettlerelectronics.pl)

### CHINA

Zettler Group, China  
[www.zettlercn.com](http://www.zettlercn.com)  
[relay@zettlercn.com](mailto:relay@zettlercn.com)

### ASIA PACIFIC



Zettler Electronics (HK) Ltd.  
[www.zettlerhk.com](http://www.zettlerhk.com)  
[sales@zettlerhk.com](mailto:sales@zettlerhk.com)



**ZETTLER**

## Looking for pricing, stock, or lifecycle information?

Click below to explore more details on WIN SOURCE:

-  [View AZ2100-1C-24DEF on WIN SOURCE](#)
-  [American Zettler, Inc. Information](#)

## Optimize Your Supply Chain with WIN SOURCE Solutions

-  Global Sourcing Solution
-  Obsolete Management
-  Cost Control Management
-  Shortage Management
-  Alternative Solution
-  Excess Inventory Management