

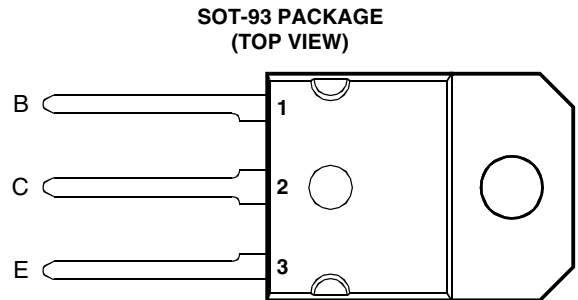

# THE DATASHEET OF BD245C



- Designed for Complementary Use with the BD246 Series
- 80 W at 25°C Case Temperature
- 10 A Continuous Collector Current
- 15 A Peak Collector Current
- Customer-Specified Selections Available



Pin 2 is in electrical contact with the mounting base.

MDTRAAA

**absolute maximum ratings at 25°C case temperature (unless otherwise noted)**

RATING		SYMBOL	VALUE	UNIT
Collector-emitter voltage ( $R_{BE} = 100 \Omega$ )	BD245	$V_{CER}$	55	V
	BD245A		70	
	BD245B		90	
	BD245C		115	
Collector-emitter voltage ( $I_C = 30 \text{ mA}$ )	BD245	$V_{CEO}$	45	V
	BD245A		60	
	BD245B		80	
	BD245C		100	
Emitter-base voltage		$V_{EBO}$	5	V
Continuous collector current		$I_C$	10	A
Peak collector current (see Note 1)		$I_{CM}$	15	A
Continuous base current		$I_B$	3	A
Continuous device dissipation at (or below) 25°C case temperature (see Note 2)		$P_{tot}$	80	W
Continuous device dissipation at (or below) 25°C free air temperature (see Note 3)		$P_{tot}$	3	W
Unclamped inductive load energy (see Note 4)		$\frac{1}{2}LI_C^2$	62.5	mJ
Operating junction temperature range		$T_j$	-65 to +150	°C
Storage temperature range		$T_{stg}$	-65 to +150	°C
Lead temperature 3.2 mm from case for 10 seconds		$T_L$	250	°C

- NOTES: 1. This value applies for  $t_p \leq 0.3 \text{ ms}$ , duty cycle  $\leq 10\%$ .  
 2. Derate linearly to 150°C case temperature at the rate of 0.64 W/°C.  
 3. Derate linearly to 150°C free air temperature at the rate of 24 mW/°C.  
 4. This rating is based on the capability of the transistor to operate safely in a circuit of:  $L = 20 \text{ mH}$ ,  $I_{B(on)} = 0.4 \text{ A}$ ,  $R_{BE} = 100 \Omega$ ,  $V_{BE(off)} = 0$ ,  $R_S = 0.1 \Omega$ ,  $V_{CC} = 20 \text{ V}$ .

**PRODUCT INFORMATION**

# BD245, BD245A, BD245B, BD245C NPN SILICON POWER TRANSISTORS

**BOURNS®**

## electrical characteristics at 25°C case temperature

PARAMETER	TEST CONDITIONS			MIN	TYP	MAX	UNIT
$V_{(BR)CEO}$ Collector-emitter breakdown voltage	$I_C = 30 \text{ mA}$ (see Note 5)	$I_B = 0$	BD245 BD245A BD245B BD245C	45 60 80 100			V
$I_{CES}$ Collector-emitter cut-off current	$V_{CE} = 55 \text{ V}$ $V_{CE} = 70 \text{ V}$ $V_{CE} = 90 \text{ V}$ $V_{CE} = 115 \text{ V}$	$V_{BE} = 0$ $V_{BE} = 0$ $V_{BE} = 0$ $V_{BE} = 0$	BD245 BD245A BD245B BD245C			0.4 0.4 0.4 0.4	mA
$I_{CEO}$ Collector cut-off current	$V_{CE} = 30 \text{ V}$ $V_{CE} = 60 \text{ V}$	$I_B = 0$ $I_B = 0$	BD245/245A BD245B/245C			0.7 0.7	mA
$I_{EBO}$ Emitter cut-off current	$V_{EB} = 5 \text{ V}$	$I_C = 0$				1	mA
$h_{FE}$ Forward current transfer ratio	$V_{CE} = 4 \text{ V}$ $V_{CE} = 4 \text{ V}$ $V_{CE} = 4 \text{ V}$	$I_C = 1 \text{ A}$ $I_C = 3 \text{ A}$ $I_C = 10 \text{ A}$	(see Notes 5 and 6)	40 20 4			
$V_{CE(sat)}$ Collector-emitter saturation voltage	$I_B = 0.3 \text{ A}$ $I_B = 2.5 \text{ A}$	$I_C = 3 \text{ A}$ $I_C = 10 \text{ A}$	(see Notes 5 and 6)			1 4	V
$V_{BE}$ Base-emitter voltage	$V_{CE} = 4 \text{ V}$ $V_{CE} = 4 \text{ V}$	$I_C = 3 \text{ A}$ $I_C = 10 \text{ A}$	(see Notes 5 and 6)			1.6 3	V
$h_{fe}$ Small signal forward current transfer ratio	$V_{CE} = 10 \text{ V}$	$I_C = 0.5 \text{ A}$	$f = 1 \text{ kHz}$	20			
$ h_{fe} $ Small signal forward current transfer ratio	$V_{CE} = 10 \text{ V}$	$I_C = 0.5 \text{ A}$	$f = 1 \text{ MHz}$	3			

NOTES: 5. These parameters must be measured using pulse techniques,  $t_p = 300 \mu\text{s}$ , duty cycle  $\leq 2\%$ .

6. These parameters must be measured using voltage-sensing contacts, separate from the current carrying contacts.

## thermal characteristics

PARAMETER	MIN	TYP	MAX	UNIT
$R_{\theta JC}$ Junction to case thermal resistance			1.56	°C/W
$R_{\theta JA}$ Junction to free air thermal resistance			42	°C/W

## resistive-load-switching characteristics at 25°C case temperature

PARAMETER	TEST CONDITIONS †			MIN	TYP	MAX	UNIT
$t_{on}$ Turn-on time	$I_C = 1 \text{ A}$	$I_{B(on)} = 0.1 \text{ A}$	$I_{B(off)} = -0.1 \text{ A}$		0.3		$\mu\text{s}$
$t_{off}$ Turn-off time	$V_{BE(off)} = -3.7 \text{ V}$	$R_L = 20 \Omega$	$t_p = 20 \mu\text{s}$ , dc $\leq 2\%$		1		$\mu\text{s}$

† Voltage and current values shown are nominal; exact values vary slightly with transistor parameters.

## PRODUCT INFORMATION

JUNE 1973 - REVISED SEPTEMBER 2002  
Specifications are subject to change without notice.

**TYPICAL CHARACTERISTICS**

**TYPICAL DC CURRENT GAIN  
vs  
COLLECTOR CURRENT**

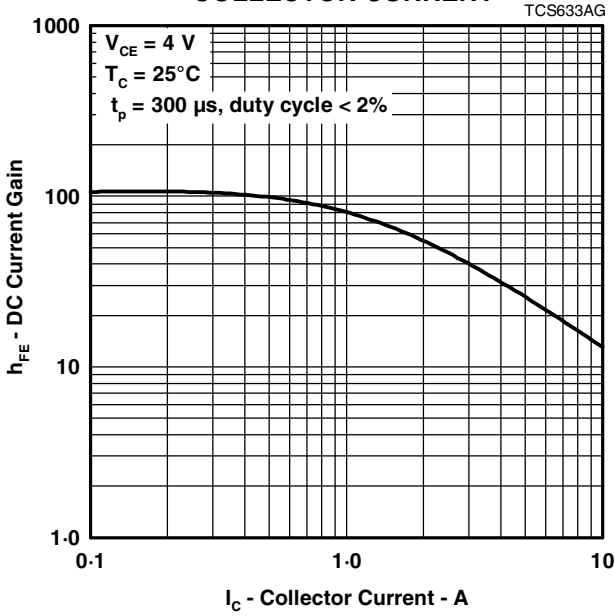

**Figure 1.**

**COLLECTOR-EMITTER SATURATION VOLTAGE  
vs  
BASE CURRENT**

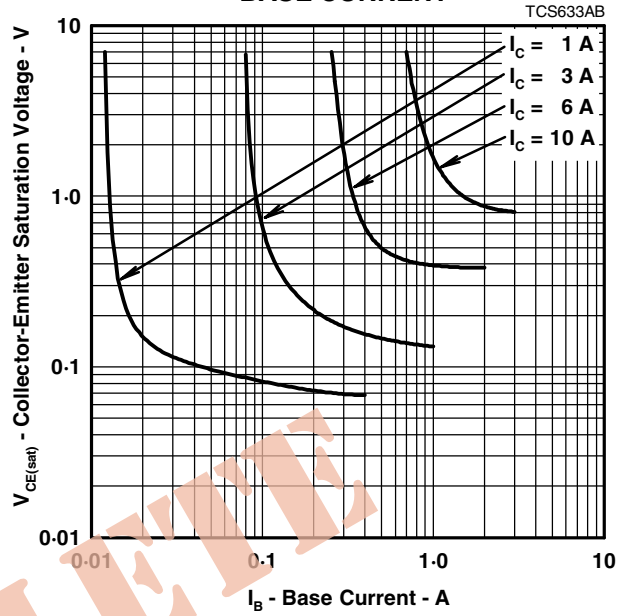

**Figure 2.**

**BASE-EMITTER VOLTAGE  
vs  
COLLECTOR CURRENT**

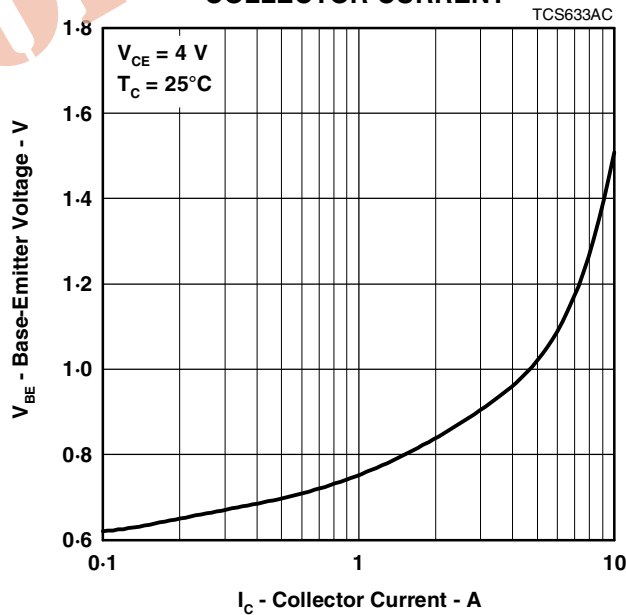

**Figure 3.**

**PRODUCT INFORMATION**

JUNE 1973 - REVISED SEPTEMBER 2002  
Specifications are subject to change without notice.

**MAXIMUM SAFE OPERATING REGIONS**

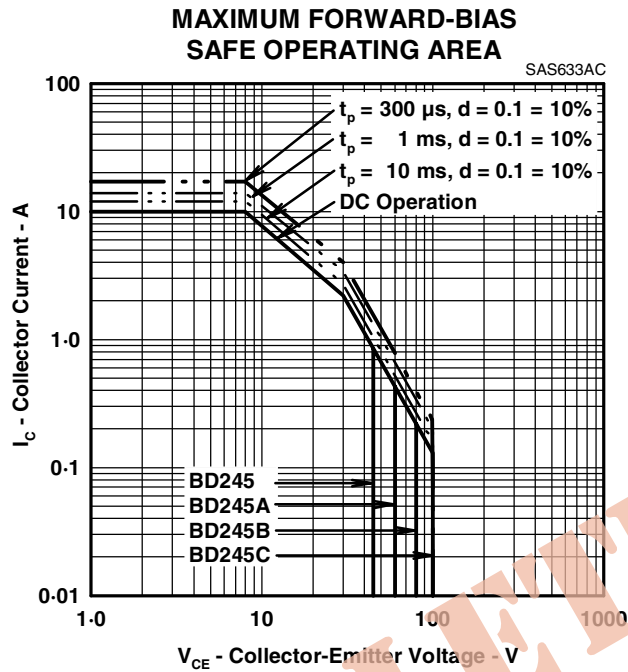

Figure 4.

**THERMAL INFORMATION**

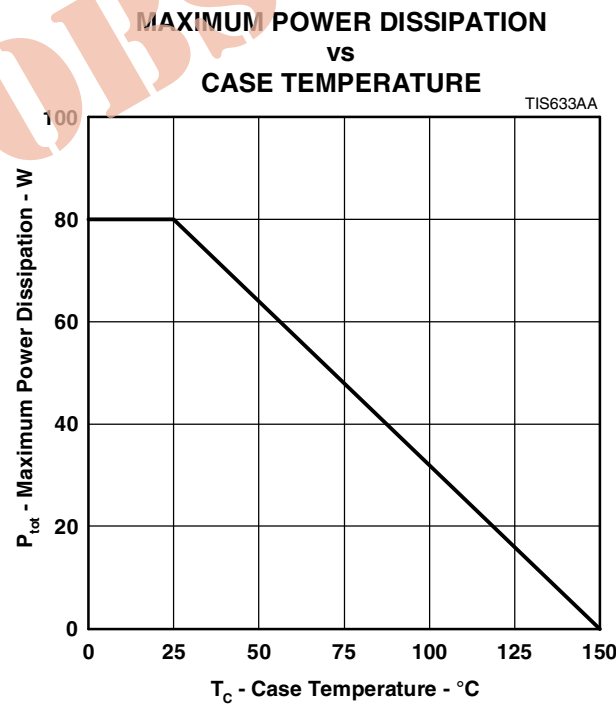



Figure 5.

**PRODUCT INFORMATION**

JUNE 1973 - REVISED SEPTEMBER 2002  
Specifications are subject to change without notice.

## Looking for pricing, stock, or lifecycle information?

Click below to explore more details on WIN SOURCE:

-  [View BD245C on WIN SOURCE](#)
-  [Bourns Inc. Information](#)

## Optimize Your Supply Chain with WIN SOURCE Solutions

-  Global Sourcing Solution
-  Obsolete Management
-  Cost Control Management
-  Shortage Management
-  Alternative Solution
-  Excess Inventory Management