



**THE DATASHEET OF
CHL8328-01CRT**



FEATURES

- 6-phase & 8-phase dual output PWM Controller
- Phases are flexibly assigned between Loops 1 & 2
- Intel® VR12, AMD® 3.4MHz SVI/PVI & Memory modes
- Overclocking & Gaming Mode with Vmax setting
- Switching frequency from 200kHz to 1.2MHz per phase
- IR Efficiency Shaping Features including Variable Gate Drive and Dynamic Phase Control
- Programmable 1-phase or 2-phase for Light Loads and Active Diode Emulation for Very Light Loads
- IR Adaptive Transient Algorithm (ATA) on both loops minimizes output bulk capacitors and system cost
- Auto-Phase Detection with auto-compensation
- Per-Loop Fault Protection: OVP, UVP, OCP, OTP, CFP
- I2C/SMBus/PMBus system interface for telemetry of Temperature, Voltage, Current & Power for both loops
- Non-Volatile Memory (NVM) for custom configuration
- Compatible with IR ATL and 3.3V Tri-state Drivers
- +3.3V supply voltage; -20°C to 85°C ambient operation
- Pb-Free, RoHS, 7x7 48-pin & 8x8 56-pin QFN, MSL2 package

APPLICATIONS

- Intel® VR12 & AMD® SVI & PVI based systems
- DDR Memory with Vtt tracking
- Overclocked & Gaming platforms

DESCRIPTION

The IR3536/CHL8326 and IR3538/CHL8328 are dual-loop digital multi-phase buck controllers. The IR3536/CHL8326 drive up to 6 phases and the IR3538/CHL8328 drives up to 8 phases. The IR3536/CHL8326 and IR3538/CHL8328 are fully Intel® VR12 and AMD® SVI/PVI compliant on both loops and provide a Vtt tracking function for DDR memory.

The IR3536/CHL8326 and IR3538/CHL8328 include the IR Efficiency Shaping Technology to deliver exceptional efficiency at minimum cost across the entire load range. IR Variable Gate Drive optimizes the MOSFET gate drive voltage based on real-time load current. IR Dynamic Phase Control adds/drops phases based upon load current. The IR3536/CHL8326 and IR3538/CHL8328 can be configured to enter 1-phase operation and active diode emulation mode automatically or by command.

IR's unique Adaptive Transient Algorithm (ATA), based on proprietary non-linear digital PWM algorithms, minimizes output bulk capacitors.

The I2C/PMBus interface can communicate with up to 16 IR3536/CHL8326 and IR3538/CHL8328 based VR loops. Device configuration and fault parameters are easily defined using the IR Intuitive Power Designer (DPDC) GUI and stored in on-chip NVM.

The IR3536/CHL8326 and IR3538/CHL8328 provides extensive OVP, UVP, OCP and OTP fault protection and includes thermistor based temperature sensing with VR_HOT signal.

NVM storage saves pins and enables a small package size. The IR3536/CHL8326 and IR3538/CHL8328 also include numerous features like register diagnostics for fast design cycles and platform differentiation, truly simplifying VRD design and enabling fastest time-to-market with its "set-and-forget" methodology.

PIN DIAGRAM

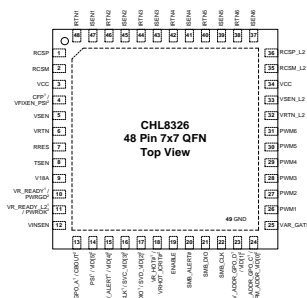

Figure 1: IR3536/CHL8326 Package Top View

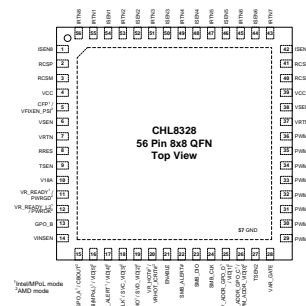
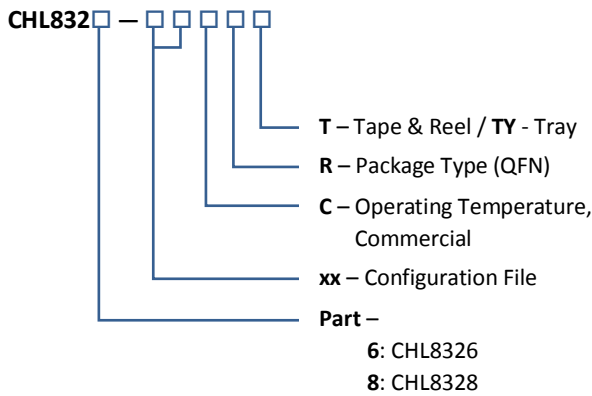
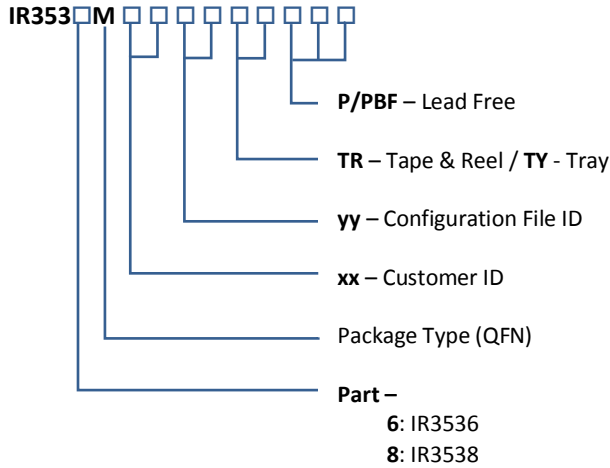

Figure 2: IR3538/CHL8328 Package Top View

ORDERING INFORMATION



Package	Packing Qty	Part Number	Programming
QFN	TR=3000	IR3536MTRPBF	Default
	TY=2600	IR3536MTYPBF	
QFN	TR=3000	IR3538MTRPBF	Default
	TY=2600	IR3538MTYPBF	
QFN	TR=3000	IR3536MxxyyTRP¹	Customer Configuration
QFN	TR=3000	IR3538MxxyyTRP¹	Customer Configuration

Notes:

1. Customer Specific Configuration File, where xx = Customer ID and yy = Configuration File (Codes assigned by IR Marketing).

Package	Packing Qty	Part Number
QFN	T=3000	CHL8326-00CRT
	TY=2600	CHL8326-00CRTY
QFN	T=3000	CHL8326-xxCRT¹
QFN	T=3000	CHL8328-00CRT
	TY=2600	CHL8328-00CRTY
QFN	T=3000	CHL8328-xxCRT¹

Notes:

1. "xx" indicates a customer specific configuration file.

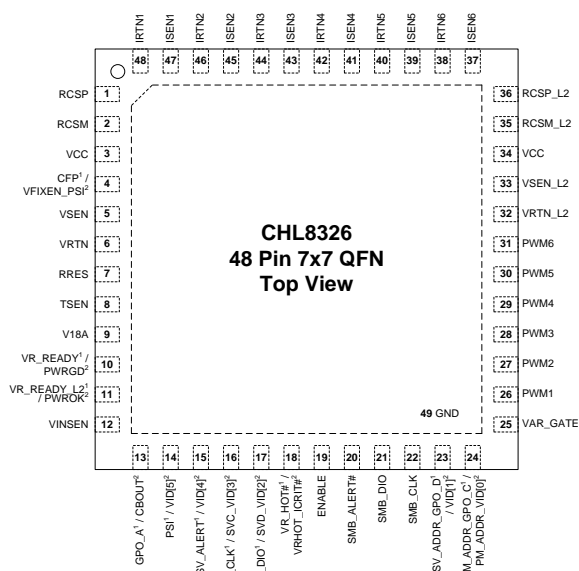

Figure 3: IR3536/CHL8326 Package Top View, Enlarged

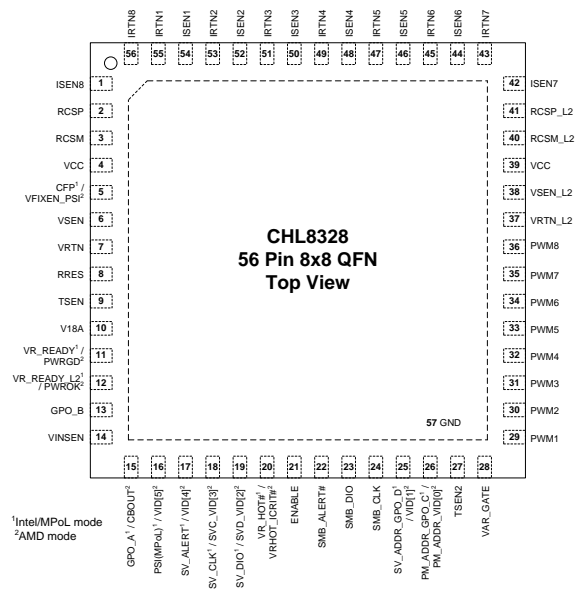

Figure 4: IR3538/CHL8328 Package Top View, Enlarged

FUNCTIONAL BLOCK DIAGRAM

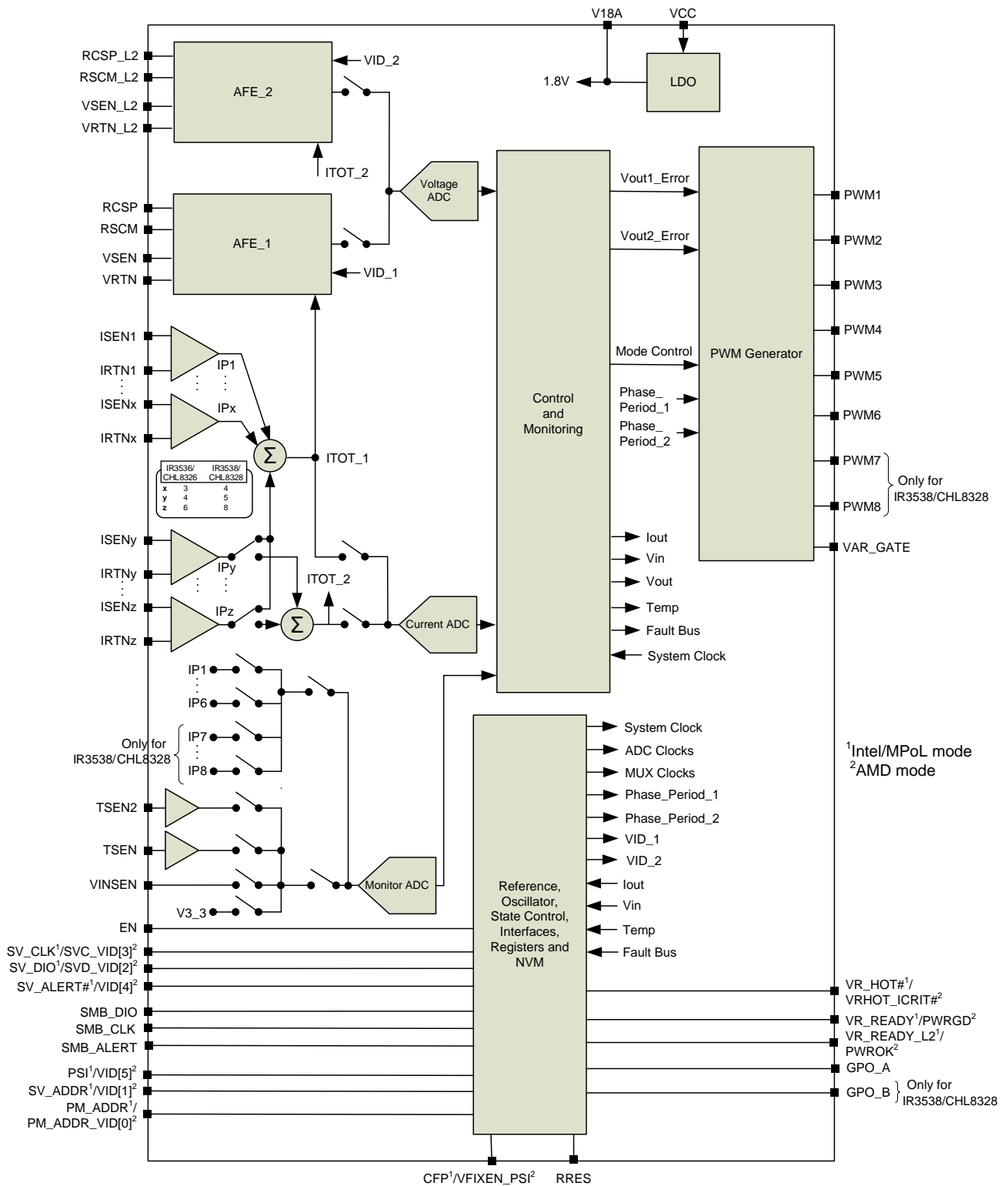

Figure 5: IR3536/CHL8326 and CHL8328 Functional Block Diagram

Looking for pricing, stock, or lifecycle information?

Click below to explore more details on WIN SOURCE:

 [View CHL8328-01CRT on WIN SOURCE](#)

 [Infineon Technologies](#) Information

Optimize Your Supply Chain with WIN SOURCE Solutions

-  Global Sourcing Solution
-  Obsolete Management
-  Cost Control Management
-  Shortage Management
-  Alternative Solution
-  Excess Inventory Management