

BD436G, BD438G, BD440G, BD442G

Plastic Medium Power Silicon PNP Transistor

This series of plastic, medium-power silicon PNP transistors can be used for amplifier and switching applications. Complementary types are BD437 and BD441.

Features

- These Devices are Pb-Free and are RoHS Compliant*

MAXIMUM RATINGS

Rating	Symbol	Value	Unit
Collector-Emitter Voltage BD436G BD438G BD440G BD442G	V_{CEO}	32 45 60 80	Vdc
Collector-Base Voltage BD436G BD438G BD440G BD442G	V_{CBO}	32 45 60 80	Vdc
Emitter-Base Voltage	V_{EBO}	5.0	Vdc
Collector Current	I_C	4.0	Adc
Base Current	I_B	1.0	Adc
Total Device Dissipation @ $T_C = 25^\circ\text{C}$ Derate above 25°C	P_D	36 288	W W/ $^\circ\text{C}$
Operating and Storage Junction Temperature Range	T_J, T_{stg}	-55 to +150	$^\circ\text{C}$

Stresses exceeding those listed in the Maximum Ratings table may damage the device. If any of these limits are exceeded, device functionality should not be assumed, damage may occur and reliability may be affected.

THERMAL CHARACTERISTICS

Characteristic	Symbol	Max	Unit
Thermal Resistance, Junction-to-Case	$R_{\theta JC}$	3.5	$^\circ\text{C/W}$

*For additional information on our Pb-Free strategy and soldering details, please download the ON Semiconductor Soldering and Mounting Techniques Reference Manual, SOLDERRM/D.



ON Semiconductor®

<http://onsemi.com>

4.0 AMP POWER TRANSISTORS PNP SILICON

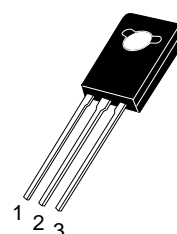
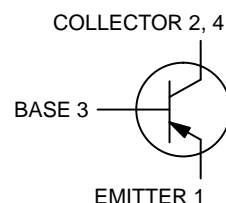

TO-225
CASE 77-09
STYLE 1

MARKING DIAGRAM

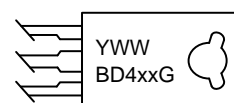

Y = Year
WW = Work Week
BD4xx = Device Code
xx = 36, 36T, 38, 38T, 40, 42
G = Pb-Free Package

ORDERING INFORMATION

Device	Package	Shipping
BD436G	TO-225 (Pb-Free)	500 Units/Box
BD436TG	TO-225 (Pb-Free)	50 Units/Rail
BD438G	TO-225 (Pb-Free)	500 Units/Box
BD438TG	TO-225 (Pb-Free)	50 Units/Rail
BD440G	TO-225 (Pb-Free)	500 Units/Box
BD442G	TO-225 (Pb-Free)	500 Units/Box

BD436G, BD438G, BD440G, BD442G

ELECTRICAL CHARACTERISTICS (T_C = 25°C unless otherwise noted)

Characteristic	Symbol	Min	Typ	Max	Unit
Collector–Emitter Breakdown Voltage (I _C = 100 mA, I _B = 0) BD436G BD438G BD440G BD442G	V _{(BR)CEO}	32 45 60 80	– – – –	– – – –	Vdc
Collector–Base Breakdown Voltage (I _C = 100 μA, I _B = 0) BD436G BD438G BD440G BD442G	V _{(BR)CBO}	32 45 60 80	– – – –	– – – –	Vdc
Emitter–Base Breakdown Voltage (I _E = 100 μA, I _C = 0)	V _{(BR)EBO}	5.0	–	–	Vdc
Collector Cutoff Current (V _{CB} = 32 V, I _E = 0) BD436G (V _{CB} = 45 V, I _E = 0) BD438G (V _{CB} = 60 V, I _E = 0) BD440G (V _{CB} = 80 V, I _E = 0) BD442G	I _{CBO}	– – – –	– – – –	0.1 0.1 0.1 0.1	mAdc
Emitter Cutoff Current (V _{EB} = 5.0 V)	I _{EBO}	–	–	1.0	mAdc
DC Current Gain (I _C = 10 mA, V _{CE} = 5.0 V) BD436G BD438G BD440G BD442G	h _{FE}	40 30 20 15	– – – –	– – – –	–
DC Current Gain (I _C = 500 mA, V _{CE} = 1.0 V) BD436G BD438G BD440G BD442G	h _{FE}	85 85 40 40	– – – –	475 475 475 475	–
DC Current Gain (I _C = 2.0 A, V _{CE} = 1.0 V) BD436G BD438G BD440G BD442G	h _{FE}	50 40 25 15	– – – –	– – – –	–
Collector Saturation Voltage (I _C = 2.0 A, I _B = 0.2 A) BD436G (I _C = 3.0 A, I _B = 0.3 A) BD438G BD440G BD442G	V _{CE(sat)}	– – – –	– – – –	0.5 0.7 0.8 0.8	Vdc
Base–Emitter On Voltage (I _C = 2.0 A, V _{CE} = 1.0 V) BD436G/BD438G BD440G/BD442G	V _{BE(ON)}	– –	– –	1.1 1.5	Vdc
Current–Gain – Bandwidth Product (V _{CE} = 1.0 V, I _C = 250 mA, f = 1.0 MHz)	f _T	3.0	–	–	MHz

Product parametric performance is indicated in the Electrical Characteristics for the listed test conditions, unless otherwise noted. Product performance may not be indicated by the Electrical Characteristics if operated under different conditions.

BD436G, BD438G, BD440G, BD442G

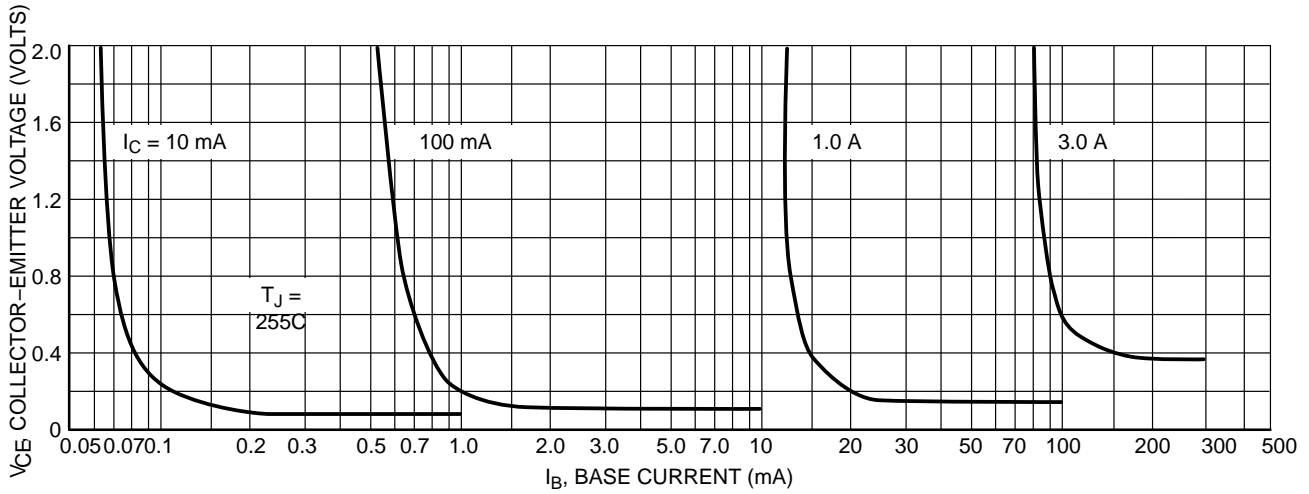

Figure 1. Collector Saturation Region

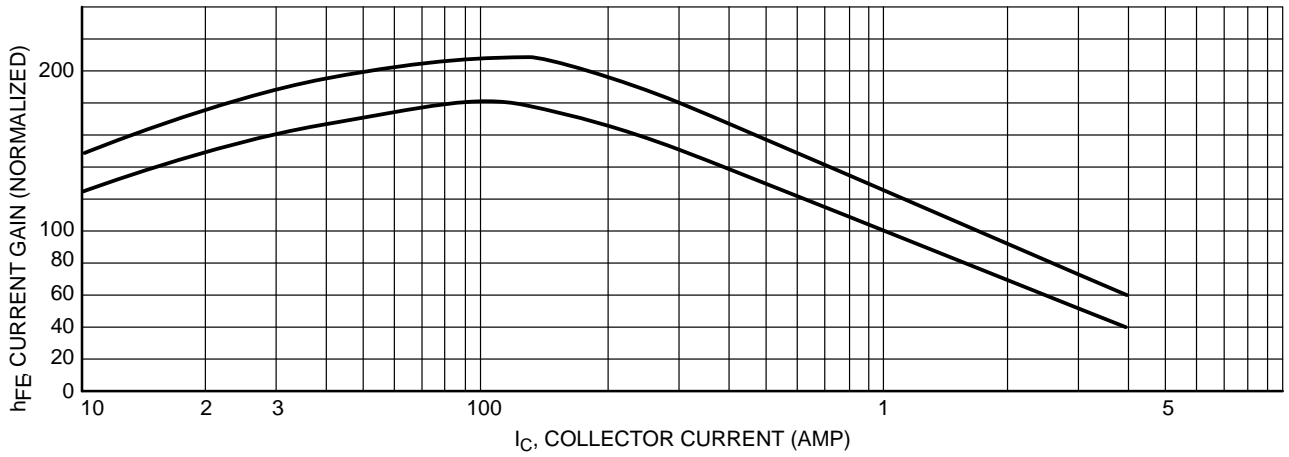

Figure 2. Current Gain

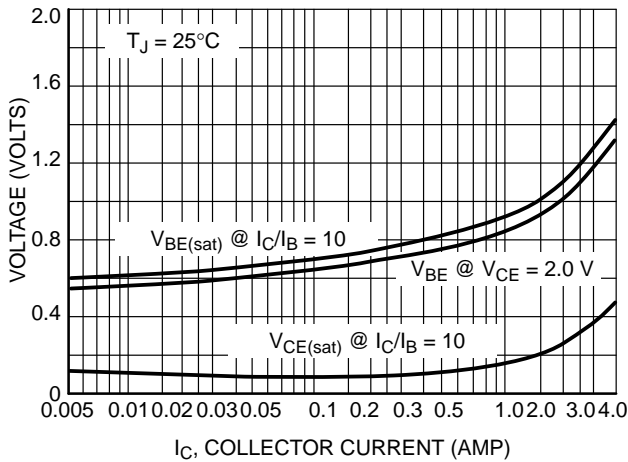

Figure 3. "On" Voltage

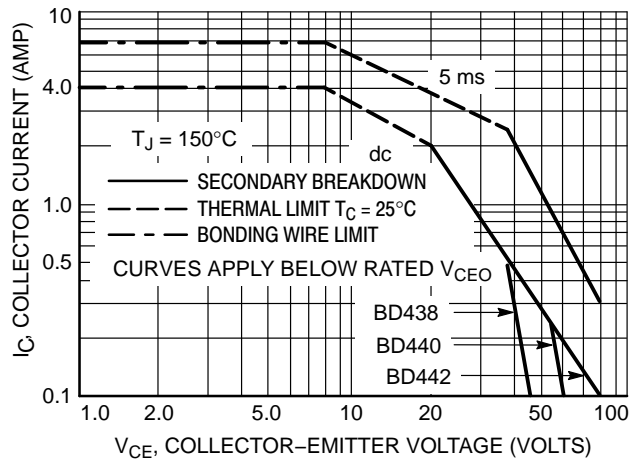
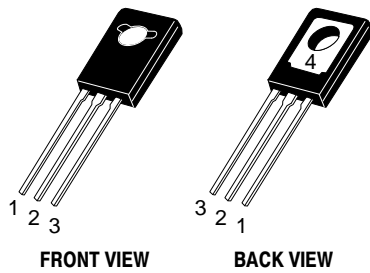

Figure 4. Active Region Safe Operating Area

BD436G, BD438G, BD440G, BD442G

PACKAGE DIMENSIONS



TO-225
CASE 77-09
ISSUE AC

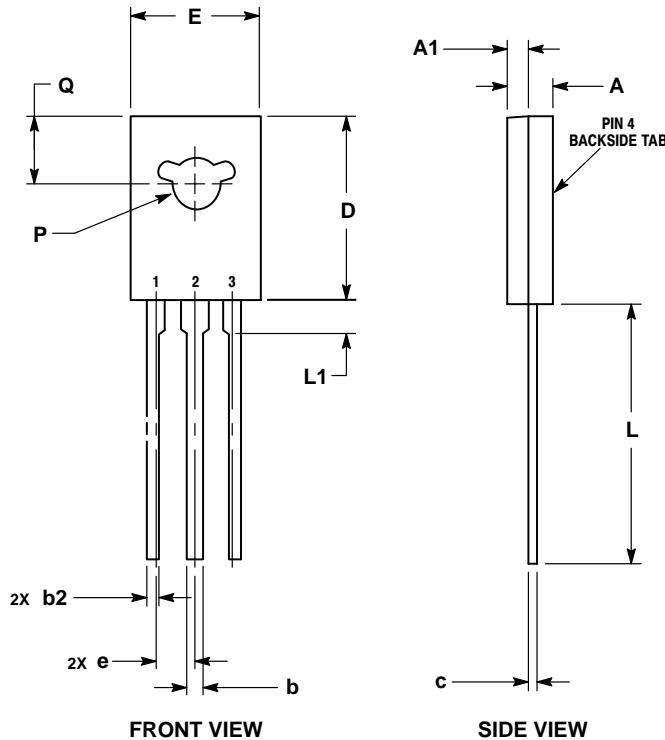

NOTES:

1. DIMENSIONING AND TOLERANCING PER ASME Y14.5M, 1994.
2. CONTROLLING DIMENSION: MILLIMETERS.
3. NUMBER AND SHAPE OF LUGS OPTIONAL.

DIM	MILLIMETERS	
	MIN	MAX
A	2.40	3.00
A1	1.00	1.50
b	0.60	0.90
b2	0.51	0.88
c	0.39	0.63
D	10.60	11.10
E	7.40	7.80
e	2.04	2.54
L	14.50	16.63
L1	1.27	2.54
P	2.90	3.30
Q	3.80	4.20

STYLE 1:

- PIN 1. EMITTER
- 2, 4. COLLECTOR
3. BASE

ON Semiconductor and are registered trademarks of Semiconductor Components Industries, LLC (SCILLC). SCILLC owns the rights to a number of patents, trademarks, copyrights, trade secrets, and other intellectual property. A listing of SCILLC's product/patent coverage may be accessed at www.onsemi.com/site/pdf/Patent-Marking.pdf. SCILLC reserves the right to make changes without further notice to any products herein. SCILLC makes no warranty, representation or guarantee regarding the suitability of its products for any particular purpose, nor does SCILLC assume any liability arising out of the application or use of any product or circuit, and specifically disclaims any and all liability, including without limitation special, consequential or incidental damages. "Typical" parameters which may be provided in SCILLC data sheets and/or specifications can and do vary in different applications and actual performance may vary over time. All operating parameters, including "Typicals" must be validated for each customer application by customer's technical experts. SCILLC does not convey any license under its patent rights nor the rights of others. SCILLC products are not designed, intended, or authorized for use as components in systems intended for surgical implant into the body, or other applications intended to support or sustain life, or for any other application in which the failure of the SCILLC product could create a situation where personal injury or death may occur. Should Buyer purchase or use SCILLC products for any such unintended or unauthorized application, Buyer shall indemnify and hold SCILLC and its officers, employees, subsidiaries, affiliates, and distributors harmless against all claims, costs, damages, and expenses, and reasonable attorney fees arising out of, directly or indirectly, any claim of personal injury or death associated with such unintended or unauthorized use, even if such claim alleges that SCILLC was negligent regarding the design or manufacture of the part. SCILLC is an Equal Opportunity/Affirmative Action Employer. This literature is subject to all applicable copyright laws and is not for resale in any manner.

PUBLICATION ORDERING INFORMATION

LITERATURE FULFILLMENT:

Literature Distribution Center for ON Semiconductor
P.O. Box 5163, Denver, Colorado 80217 USA
Phone: 303-675-2175 or 800-344-3860 Toll Free USA/Canada
Fax: 303-675-2176 or 800-344-3867 Toll Free USA/Canada
Email: orderlit@onsemi.com

N. American Technical Support: 800-282-9855 Toll Free
USA/Canada
Europe, Middle East and Africa Technical Support:
Phone: 421 33 790 2910
Japan Customer Focus Center
Phone: 81-3-5817-1050



ON Semiconductor Website: www.onsemi.com

Order Literature: <http://www.onsemi.com/orderlit>

For additional information, please contact your local Sales Representative

Looking for pricing, stock, or lifecycle information?

Click below to explore more details on WIN SOURCE:

-  [View BD440G on WIN SOURCE](#)
-  [ON Semiconductor Information](#)

Optimize Your Supply Chain with WIN SOURCE Solutions

-  Global Sourcing Solution
-  Obsolete Management
-  Cost Control Management
-  Shortage Management
-  Alternative Solution
-  Excess Inventory Management