



**THE DATASHEET OF  
DS1811-10**



### FEATURES

- Automatically restarts a microprocessor after power failure
- Maintains reset for 150 ms after  $V_{CC}$  returns to an in-tolerance condition
- Reduces need for discrete components
- Precision temperature-compensated voltage reference and voltage sensor
- Low-cost TO-92 or space saving SOT-23 packages available
- Efficient open-drain output with internal 5.5 k $\Omega$  pull-up resistor
- Operating temperature -40°C to +85°C

### PIN ASSIGNMENT

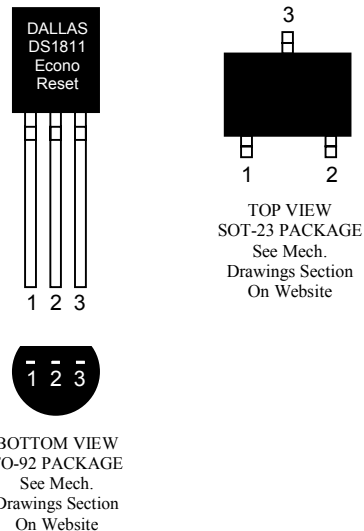

### PIN DESCRIPTION

#### TO-92

1	$\overline{RST}$	Active Low Reset Output
2	$V_{CC}$	Power Supply
3	GND	Ground

#### SOT-23

1	$\overline{RST}$	Active Low Reset Output
2	$V_{CC}$	Power Supply
3	GND	Ground

### DESCRIPTION

The DS1811 EconoReset uses a precision temperature reference and comparator circuit to monitor the status of the power supply ( $V_{CC}$ ). When an out-of-tolerance condition is detected, an internal power-fail signal is generated which forces reset to the active state. When  $V_{CC}$  returns to an in-tolerance condition, the reset signal is kept in the active state for approximately 150 ms to allow the power supply and processor to stabilize.

## OPERATION - POWER MONITOR

The DS1811 provides the functions of detecting out-of-tolerance power supply conditions and warning a processor-based system of impending power failure. When  $V_{CC}$  is detected as out-of-tolerance, the  $\overline{RST}$  signal is asserted. On power-up,  $\overline{RST}$  is kept active for approximately 150 ms after the power supply has reached the selected tolerance. This allows the power supply and microprocessor to stabilize before  $\overline{RST}$  is released.

## BLOCK DIAGRAM (OPEN-DRAIN OUTPUT) Figure 1

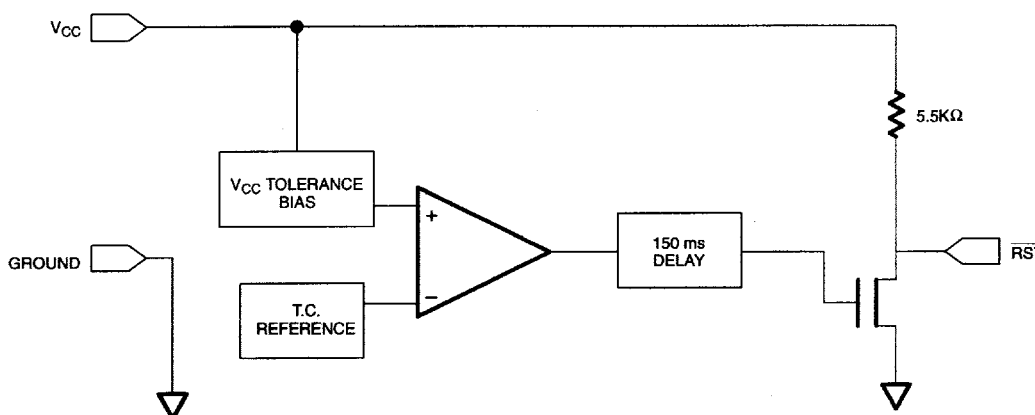

## APPLICATION EXAMPLE Figure 2

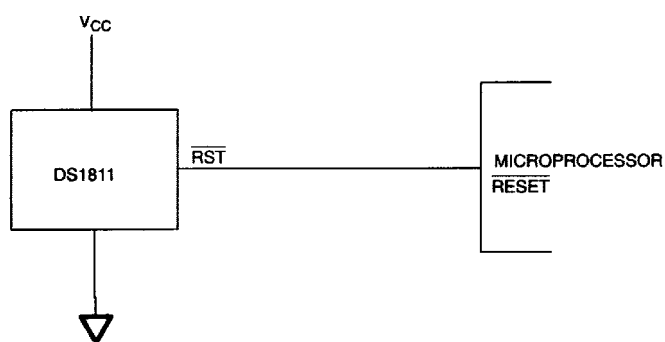

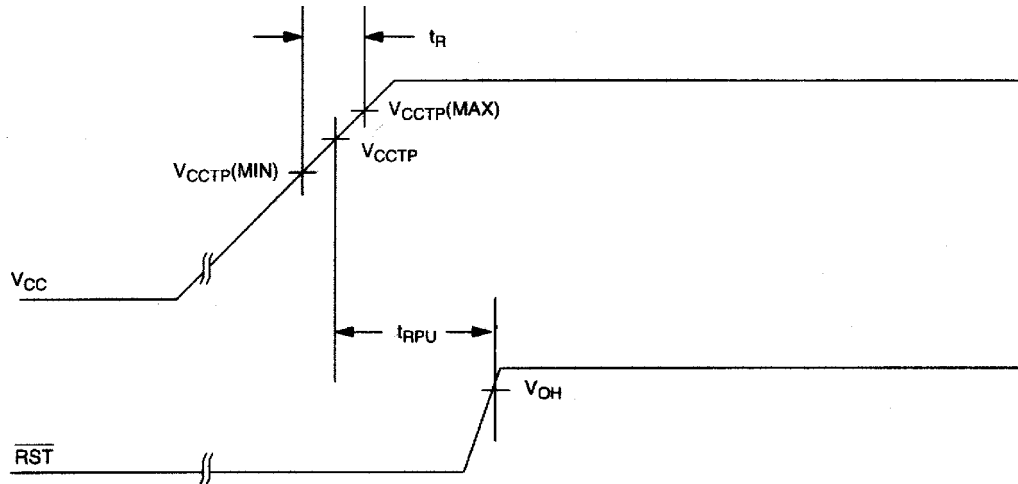
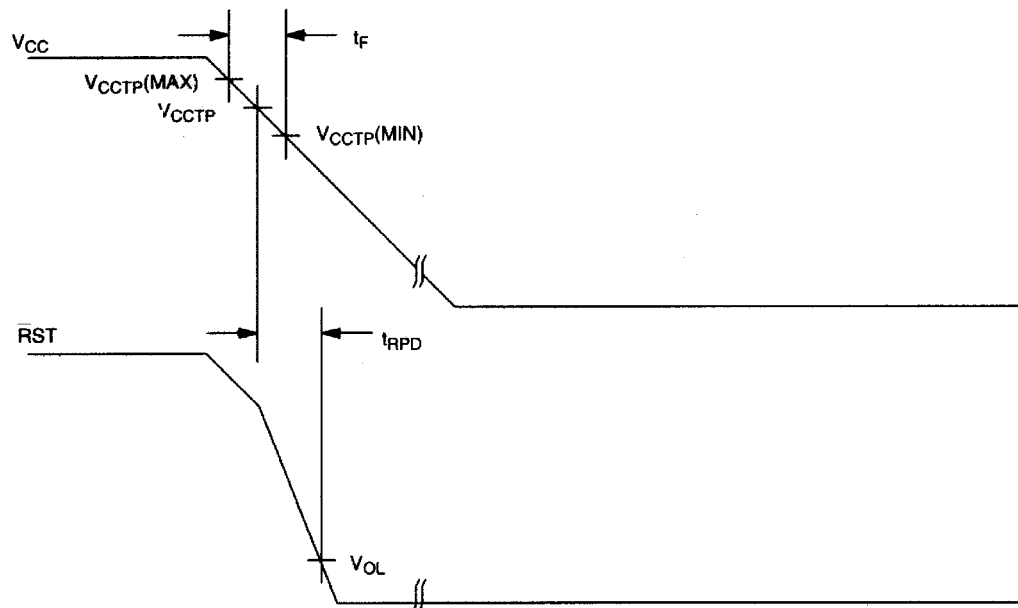
**TIMING DIAGRAM: POWER-UP** Figure 3**TIMING DIAGRAM: POWER-DOWN** Figure 4

**ABSOLUTE MAXIMUM RATINGS\***

Voltage on $V_{CC}$ Pin Relative to Ground	-0.5V to +7.0V
Voltage on $RST$ Relative to Ground	-0.5V to $V_{CC} + 0.5V$
Operating Temperature	-40°C to +85°C
Storage Temperature	-55°C to +125°C
Soldering Temperature	260°C for 10 seconds

\* This is a stress rating only and functional operation of the device at these or any other conditions above those indicated in the operation sections of this specification is not implied. Exposure to absolute maximum rating conditions for extended periods of time may affect reliability.

**RECOMMENDED DC OPERATING CONDITIONS** (-40°C to +85°C)

PARAMETER	SYMBOL	MIN	TYP	MAX	UNITS	NOTES
Supply Voltage	$V_{CC}$	0.0		5.5	V	1

**DC ELECTRICAL CHARACTERISTICS** (-40°C to +85°C;  $V_{CC}=1.2V$  to 5.5V)

PARAMETER	SYMBOL	MIN	TYP	MAX	UNITS	NOTES
Output Current @ 0.4 volts	$I_{OL}$	+10			mA	2, 3
Operating Current $V_{CC} < 5.5$ volts	$I_{CC}$		30	40	$\mu A$	4
$V_{CC}$ Trip Point (DS1811-5)	$V_{CCTP}$	4.50	4.62	4.75	V	1
$V_{CC}$ Trip Point (DS1811-10)	$V_{CCTP}$	4.25	4.35	4.49	V	1
$V_{CC}$ Trip Point (DS1811-15)	$V_{CCTP}$	4.00	4.13	4.24	V	1
Internal Pull-Up Resistor	$R_P$	3.5	5.5	7.5	k $\Omega$	
Output Capacitance	$C_{OUT}$			10	pF	

**AC ELECTRICAL CHARACTERISTICS** (-40°C to +85°C;  $V_{CC}=1.2V$  to 5.5V)

PARAMETER	SYMBOL	MIN	TYP	MAX	UNITS	NOTES
RESET Active Time	$t_{RST}$	100	150	300	ms	
$V_{CC}$ Detect to $\overline{RST}$	$t_{RPD}$		2	5	$\mu s$	
$V_{CC}$ Slew Rate ( $V_{CCTP}$ (MAX) to $V_{CCTP}$ (MIN))	$t_F$	300			$\mu s$	
$V_{CC}$ Slew Rate ( $V_{CCTP}$ (MIN) to $V_{CCTP}$ (MAX))	$t_R$	0			ns	
$V_{CC}$ Detect to $\overline{RST}$	$t_{RPU}$	100	150	300	ms	5

**NOTES:**

1. All voltages are referenced to ground.
2. Measured with  $V_{CC} \geq 2.7$  volts.
3. A  $1k\Omega$  external resistor may be required in some applications for proper operation of the microprocessor reset control circuit.
4. Measured with  $\overline{RST}$  output open.
5.  $t_R = 5 \mu s$ .

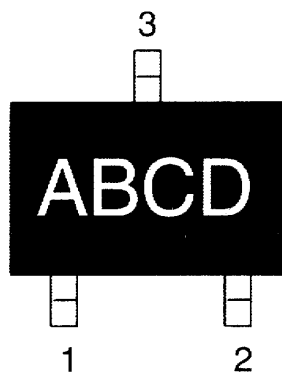
**PART MARKING CODES**

“A”, “B”, & “C” represent the device type.



810 . . . . DS1810  
 811 . . . . DS1811  
 812 . . . . DS1812  
 813 . . . . DS1813  
 815 . . . . DS1815  
 816 . . . . DS1816  
 817 . . . . DS1817  
 818 . . . . DS1818

“D” represents the device tolerance.

A . . . . . 5%  
 B . . . . . 10%  
 C . . . . . 15%  
 D . . . . . 20%

## Looking for pricing, stock, or lifecycle information?

Click below to explore more details on WIN SOURCE:

-  [View DS1811-10 on WIN SOURCE](#)
-  [Maxim Integrated Information](#)

## Optimize Your Supply Chain with WIN SOURCE Solutions

-  Global Sourcing Solution
-  Obsolete Management
-  Cost Control Management
-  Shortage Management
-  Alternative Solution
-  Excess Inventory Management