



# THE DATASHEET OF EE-SX1046



## Photomicrosensor (Transmissive) EE-SX1046

**⚠ Be sure to read *Precautions* on page 24.**

### ■ Dimensions

**Note:** All units are in millimeters unless otherwise indicated.

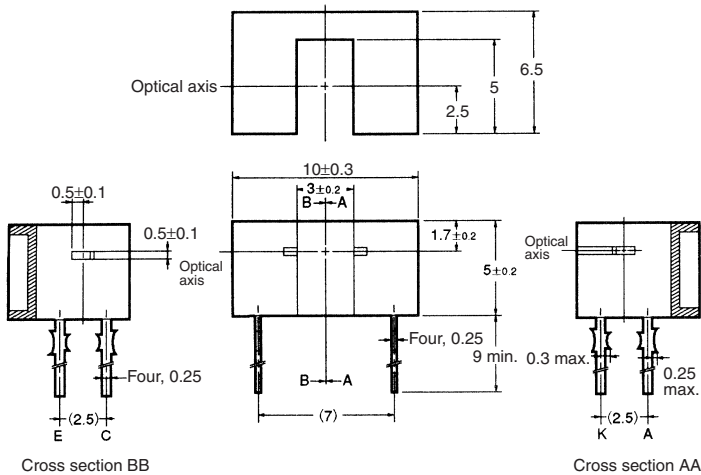

#### Internal Circuit

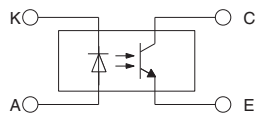

Unless otherwise specified, the tolerances are as shown below.

Dimensions	Tolerance
3 mm max.	±0.3
3 < mm ≤ 6	±0.375
6 < mm ≤ 10	±0.45
10 < mm ≤ 18	±0.55
18 < mm ≤ 30	±0.65

Terminal No.	Name
A	Anode
K	Cathode
C	Collector
E	Emitter

### ■ Features

- With a horizontal sensing aperture.
- PCB mounting type.
- High resolution with a 0.5-mm-wide aperture.

### ■ Absolute Maximum Ratings (Ta = 25°C)

Item	Symbol	Rated value
<b>Emitter</b>	<b>Forward current</b>	$I_F$ 50 mA (see note 1)
	<b>Pulse forward current</b>	$I_{FP}$ 1 A (see note 2)
	<b>Reverse voltage</b>	$V_R$ 4 V
<b>Detector</b>	<b>Collector–Emitter voltage</b>	$V_{CEO}$ 30 V
	<b>Emitter–Collector voltage</b>	$V_{ECO}$ ---
	<b>Collector current</b>	$I_C$ 20 mA
	<b>Collector dissipation</b>	$P_C$ 100 mW (see note 1)
<b>Ambient temperature</b>	<b>Operating</b>	$T_{opr}$ -25°C to 85°C
	<b>Storage</b>	$T_{stg}$ -30°C to 100°C
<b>Soldering temperature</b>	$T_{sol}$	260°C (see note 3)

- Note:**
1. Refer to the temperature rating chart if the ambient temperature exceeds 25°C.
  2. The pulse width is 10  $\mu$ s maximum with a frequency of 100 Hz.
  3. Complete soldering within 10 seconds.

### ■ Electrical and Optical Characteristics (Ta = 25°C)

Item	Symbol	Value	Condition
<b>Emitter</b>	<b>Forward voltage</b>	$V_F$ 1.2 V typ., 1.5 V max.	$I_F = 30$ mA
	<b>Reverse current</b>	$I_R$ 0.01 $\mu$ A typ., 10 $\mu$ A max.	$V_R = 4$ V
	<b>Peak emission wavelength</b>	$\lambda_P$ 920 nm typ.	$I_F = 20$ mA
<b>Detector</b>	<b>Light current</b>	$I_L$ 1.2 mA min., 14 mA max.	$I_F = 20$ mA, $V_{CE} = 5$ V
	<b>Dark current</b>	$I_D$ 2 nA typ., 200 nA max.	$V_{CE} = 10$ V, 0 lx
	<b>Leakage current</b>	$I_{LEAK}$ ---	---
	<b>Collector–Emitter saturated voltage</b>	$V_{CE(sat)}$ 0.1 V typ., 0.4 V max.	$I_F = 20$ mA, $I_L = 0.1$ mA
	<b>Peak spectral sensitivity wavelength</b>	$\lambda_P$ 850 nm typ.	$V_{CE} = 10$ V
<b>Rising time</b>	$t_r$ 4 $\mu$ s typ.	$V_{CC} = 5$ V, $R_L = 100 \Omega$ , $I_L = 5$ mA	
<b>Falling time</b>	$t_f$ 4 $\mu$ s typ.	$V_{CC} = 5$ V, $R_L = 100 \Omega$ , $I_L = 5$ mA	

Engineering Data

Forward Current vs. Collector Dissipation Temperature Rating

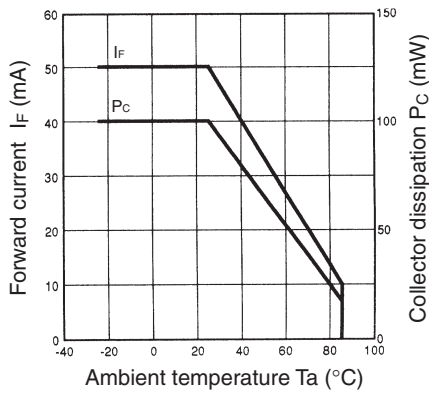

Forward Current vs. Forward Voltage Characteristics (Typical)

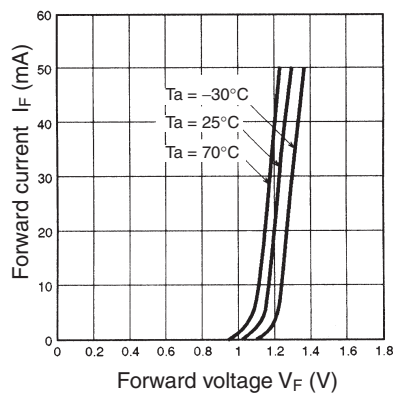

Light Current vs. Forward Current Characteristics (Typical)

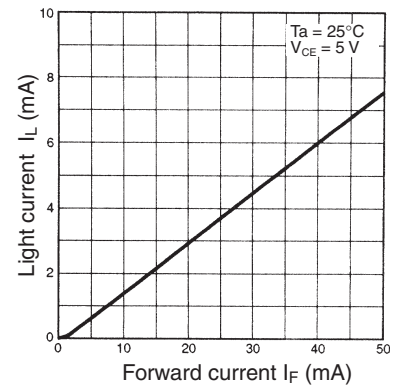

Light Current vs. Collector-Emitter Voltage Characteristics (Typical)

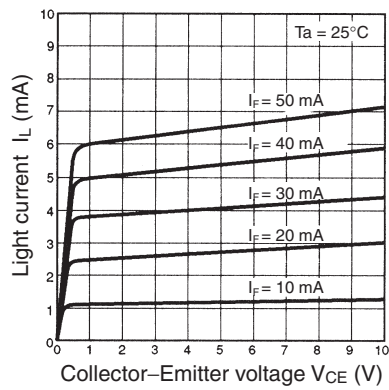

Relative Light Current vs. Ambient Temperature Characteristics (Typical)

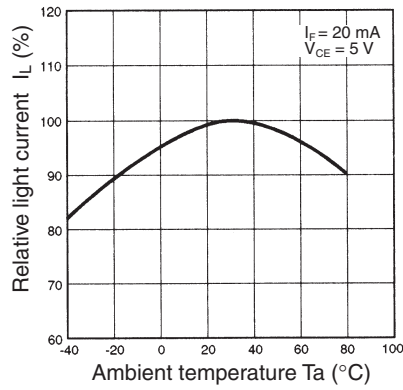

Dark Current vs. Ambient Temperature Characteristics (Typical)

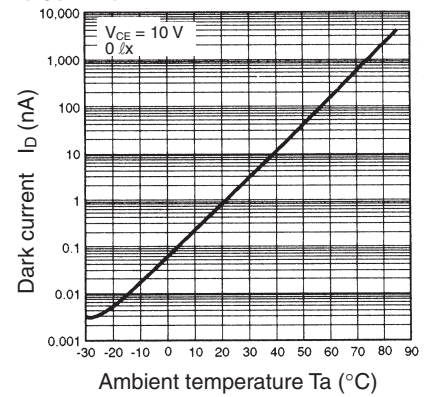

Response Time vs. Load Resistance Characteristics (Typical)

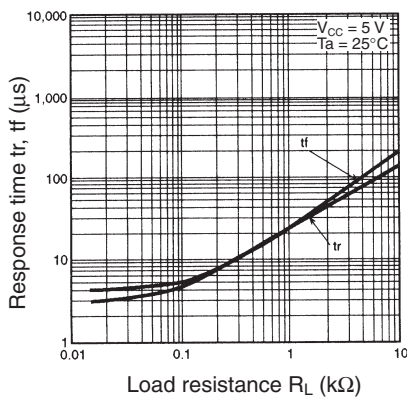

Sensing Position Characteristics (Typical)

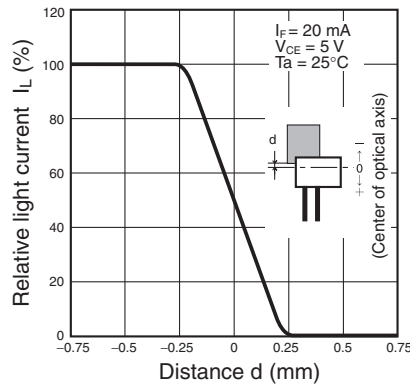

Sensing Position Characteristics (Typical)

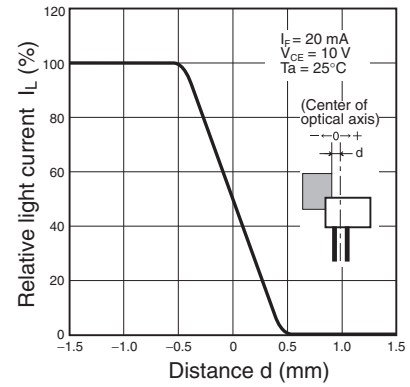

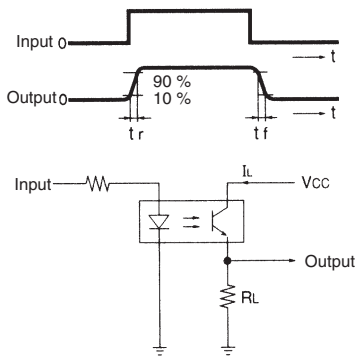

Response Time Measurement Circuit



## Looking for pricing, stock, or lifecycle information?

Click below to explore more details on WIN SOURCE:

-  [View EE-SX1046 on WIN SOURCE](#)
-  [Omron Information](#)

## Optimize Your Supply Chain with WIN SOURCE Solutions

-  Global Sourcing Solution
-  Obsolete Management
-  Cost Control Management
-  Shortage Management
-  Alternative Solution
-  Excess Inventory Management