



# ON Semiconductor

## Is Now

# onsemi™

To learn more about onsemi™, please visit our website at  
[www.onsemi.com](http://www.onsemi.com)

---

**onsemi** and **onsemi** and other names, marks, and brands are registered and/or common law trademarks of Semiconductor Components Industries, LLC dba "**onsemi**" or its affiliates and/or subsidiaries in the United States and/or other countries. **onsemi** owns the rights to a number of patents, trademarks, copyrights, trade secrets, and other intellectual property. A listing of **onsemi** product/patent coverage may be accessed at [www.onsemi.com/site/pdf/Patent-Marking.pdf](http://www.onsemi.com/site/pdf/Patent-Marking.pdf). **onsemi** reserves the right to make changes at any time to any products or information herein, without notice. The information herein is provided "as-is" and **onsemi** makes no warranty, representation or guarantee regarding the accuracy of the information, product features, availability, functionality, or suitability of its products for any particular purpose, nor does **onsemi** assume any liability arising out of the application or use of any product or circuit, and specifically disclaims any and all liability, including without limitation special, consequential or incidental damages. Buyer is responsible for its products and applications using **onsemi** products, including compliance with all laws, regulations and safety requirements or standards, regardless of any support or applications information provided by **onsemi**. "Typical" parameters which may be provided in **onsemi** data sheets and/or specifications can and do vary in different applications and actual performance may vary over time. All operating parameters, including "Typicals" must be validated for each customer application by customer's technical experts. **onsemi** does not convey any license under any of its intellectual property rights nor the rights of others. **onsemi** products are not designed, intended, or authorized for use as a critical component in life support systems or any FDA Class 3 medical devices or medical devices with a same or similar classification in a foreign jurisdiction or any devices intended for implantation in the human body. Should Buyer purchase or use **onsemi** products for any such unintended or unauthorized application, Buyer shall indemnify and hold **onsemi** and its officers, employees, subsidiaries, affiliates, and distributors harmless against all claims, costs, damages, and expenses, and reasonable attorney fees arising out of, directly or indirectly, any claim of personal injury or death associated with such unintended or unauthorized use, even if such claim alleges that **onsemi** was negligent regarding the design or manufacture of the part. **onsemi** is an Equal Opportunity/Affirmative Action Employer. This literature is subject to all applicable copyright laws and is not for resale in any manner. Other names and brands may be claimed as the property of others.



ON Semiconductor®

## FDD13AN06A0-F085

### N-Channel PowerTrench® MOSFET

60V, 50A, 13.5mΩ

#### Features

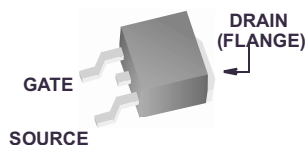
- $r_{DS(ON)} = 11.5m\Omega$  (Typ.),  $V_{GS} = 10V$ ,  $I_D = 50A$
- $Q_g(tot) = 22nC$  (Typ.),  $V_{GS} = 10V$
- Low Miller Charge
- Low  $Q_{RR}$  Body Diode
- UIS Capability (Single Pulse and Repetitive Pulse)
- Qualified to AEC Q101
- RoHS Compliant

Formerly developmental type 82555

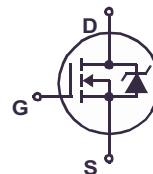


#### Applications

- Motor / Body Load Control
- ABS Systems
- Powertrain Management
- Injection Systems
- DC-DC converters and Off-line UPS
- Distributed Power Architectures and VRMs
- Primary Switch for 12V and 24V systems



TO-252AA  
FDD SERIES



#### MOSFET Maximum Ratings $T_C = 25^\circ C$ unless otherwise noted

| Symbol         | Parameter   | Ratings    | Units        |
|----------------|---|------------|--------------|
| $V_{DSS}$      | Drain to Source Voltage   | 60         | V            |
| $V_{GS}$       | Gate to Source Voltage  | $\pm 20$   | V            |
| $I_D$          | Drain Current   |            |              |
|                | Continuous ( $T_C < 80^\circ C$ , $V_{GS} = 10V$ )                                  | 50         | A            |
|                | Continuous ( $T_A = 25^\circ C$ , $V_{GS} = 10V$ , $R_{\theta JA} = 52^\circ C/W$ ) | 9.9        | A            |
|                | Pulsed  | Figure 4   | A            |
| $E_{AS}$       | Single Pulse Avalanche Energy ( Note 1)   | 56         | mJ           |
| $P_D$          | Power dissipation   | 115        | W            |
|                | Derate above $25^\circ C$   | 0.77       | $W/^\circ C$ |
| $T_J, T_{STG}$ | Operating and Storage Temperature   | -55 to 175 | $^\circ C$   |

#### Thermal Characteristics

|                 |   |     |              |
|-----------------|---|-----|--------------|
| $R_{\theta JC}$ | Thermal Resistance Junction to Case TO-252                                      | 1.3 | $^\circ C/W$ |
| $R_{\theta JA}$ | Thermal Resistance Junction to Ambient TO-252                                   | 100 | $^\circ C/W$ |
| $R_{\theta JA}$ | Thermal Resistance Junction to Ambient TO-252, 1in <sup>2</sup> copper pad area | 52  | $^\circ C/W$ |

This product has been designed to meet the extreme test conditions and environment demanded by the automotive industry. For a copy of the requirements, see AEC Q101 at: <http://www.aecouncil.com/>

FDD13AN06A0-F085 N-Channel PowerTrench® MOSFET

## Package Marking and Ordering Information

| Device Marking | Device           | Package  | Reel Size | Tape Width | Quantity   |
|----------------|------------------|----------|-----------|------------|------------|
| FDD13AN06A0    | FDD13AN06A0-F085 | TO-252AA | 330mm     | 16mm       | 2500 units |

## Electrical Characteristics $T_C = 25^\circ\text{C}$ unless otherwise noted

| Symbol | Parameter | Test Conditions | Min | Typ | Max | Units |
|--------|-----------|-----------------|-----|-----|-----|-------|
|--------|-----------|-----------------|-----|-----|-----|-------|

### Off Characteristics

|            |                                   |  |    |   |           |               |
|------------|-----------------------------------|--|----|---|-----------|---------------|
| $B_{VDSS}$ | Drain to Source Breakdown Voltage | $I_D = 250\mu\text{A}$ , $V_{GS} = 0\text{V}$  | 60 | - | -         | V             |
| $I_{DSS}$  | Zero Gate Voltage Drain Current   | $V_{DS} = 50\text{V}$                          | -  | - | 1         | $\mu\text{A}$ |
|            |                                   | $V_{GS} = 0\text{V}$ $T_C = 150^\circ\text{C}$ | -  | - | 250       |               |
| $I_{GSS}$  | Gate to Source Leakage Current    | $V_{GS} = \pm 20\text{V}$                      | -  | - | $\pm 100$ | nA            |

### On Characteristics

|              |                                  |   |   |        |        |          |
|--------------|----------------------------------|---|---|--------|--------|----------|
| $V_{GS(TH)}$ | Gate to Source Threshold Voltage | $V_{GS} = V_{DS}$ , $I_D = 250\mu\text{A}$                                | 2 | -      | 4      | V        |
| $r_{DS(ON)}$ | Drain to Source On Resistance    | $I_D = 50\text{A}$ , $V_{GS} = 10\text{V}$                                | - | 0.0115 | 0.0135 | $\Omega$ |
|              |                                  | $I_D = 25\text{A}$ , $V_{GS} = 6\text{V}$                                 | - | 0.022  | 0.034  |          |
|              |                                  | $I_D = 50\text{A}$ , $V_{GS} = 10\text{V}$ ,<br>$T_J = 175^\circ\text{C}$ | - | 0.026  | 0.030  |          |

### Dynamic Characteristics

|              |                                  |   |   |      |     |    |
|--------------|----------------------------------|---|---|------|-----|----|
| $C_{ISS}$    | Input Capacitance                | $V_{DS} = 25\text{V}$ , $V_{GS} = 0\text{V}$ ,<br>$f = 1\text{MHz}$ | - | 1350 | -   | pF |
| $C_{OSS}$    | Output Capacitance               |   | - | 260  | -   | pF |
| $C_{RSS}$    | Reverse Transfer Capacitance     |   | - | 90   | -   | pF |
| $Q_{g(TOT)}$ | Total Gate Charge at 10V         | $V_{GS} = 0\text{V}$ to 10V   | - | 22   | 29  | nC |
| $Q_{g(TH)}$  | Threshold Gate Charge            | $V_{GS} = 0\text{V}$ to 2V  | - | 2.6  | 3.4 | nC |
| $Q_{gs}$     | Gate to Source Gate Charge       | $V_{DD} = 30\text{V}$<br>$I_D = 50\text{A}$<br>$I_g = 1.0\text{mA}$ | - | 8.2  | -   | nC |
| $Q_{gs2}$    | Gate Charge Threshold to Plateau |   | - | 5.6  | -   | nC |
| $Q_{gd}$     | Gate to Drain "Miller" Charge    |   | - | 6.4  | -   | nC |

### Switching Characteristics ( $V_{GS} = 10\text{V}$ )

|              |                     |   |   |    |     |    |
|--------------|---------------------|---|---|----|-----|----|
| $t_{ON}$     | Turn-On Time        | $V_{DD} = 30\text{V}$ , $I_D = 50\text{A}$<br>$V_{GS} = 10\text{V}$ , $R_{GS} = 12\Omega$ | - | -  | 130 | ns |
| $t_{d(ON)}$  | Turn-On Delay Time  |   | - | 9  | -   | ns |
| $t_r$        | Rise Time           |   | - | 77 | -   | ns |
| $t_{d(OFF)}$ | Turn-Off Delay Time |   | - | 26 | -   | ns |
| $t_f$        | Fall Time           |   | - | 25 | -   | ns |
| $t_{OFF}$    | Turn-Off Time       |   | - | -  | 77  | ns |

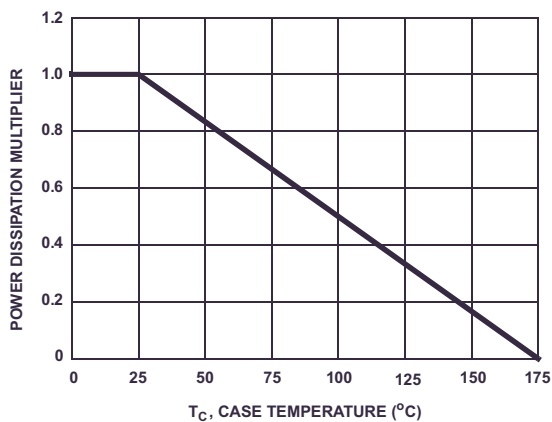
### Drain-Source Diode Characteristics

|          |                               |  |   |   |      |    |
|----------|-------------------------------|--|---|---|------|----|
| $V_{SD}$ | Source to Drain Diode Voltage | $I_{SD} = 50\text{A}$  | - | - | 1.25 | V  |
|          |                               | $I_{SD} = 25\text{A}$  | - | - | 1.0  | V  |
| $t_{rr}$ | Reverse Recovery Time         | $I_{SD} = 50\text{A}$ , $dI_{SD}/dt = 100\text{A}/\mu\text{s}$ | - | - | 24   | ns |
| $Q_{RR}$ | Reverse Recovered Charge      | $I_{SD} = 50\text{A}$ , $dI_{SD}/dt = 100\text{A}/\mu\text{s}$ | - | - | 15   | nC |

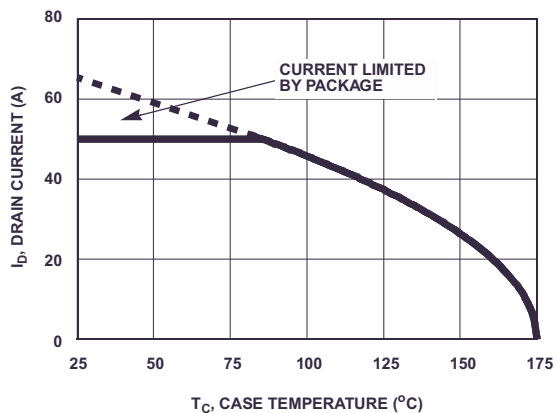
#### Notes:

1: Starting  $T_J = 25^\circ\text{C}$ ,  $L = 45\mu\text{H}$ ,  $I_{AS} = 50\text{A}$ .

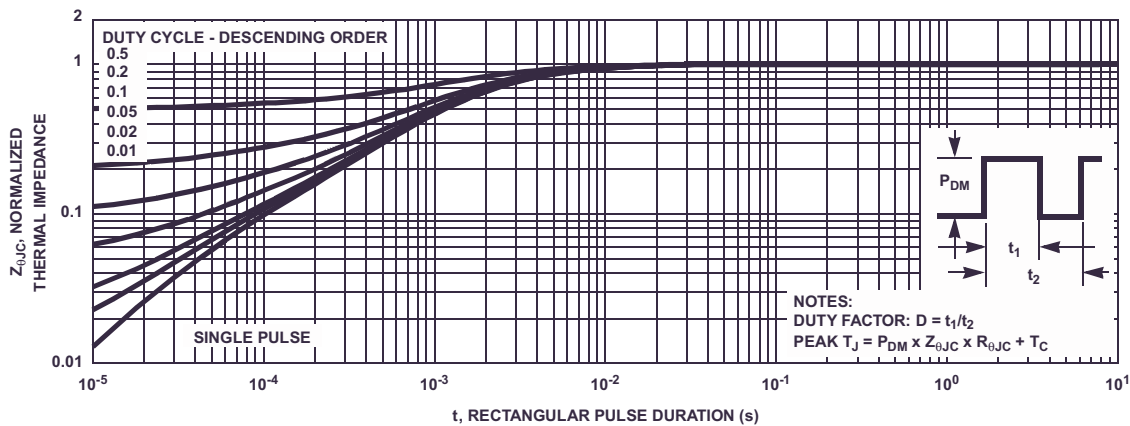
**Typical Characteristics**  $T_C = 25^\circ\text{C}$  unless otherwise noted



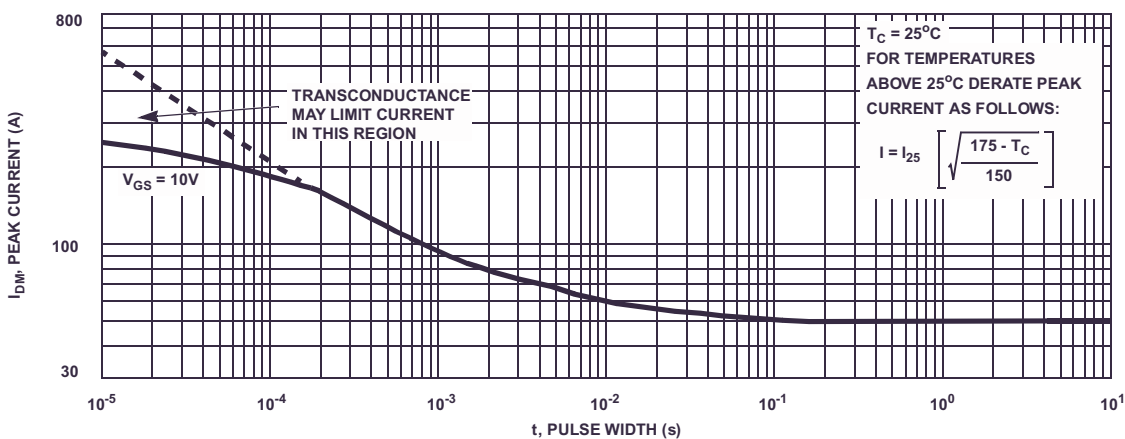
**Figure 1. Normalized Power Dissipation vs Ambient Temperature**



**Figure 2. Maximum Continuous Drain Current vs Case Temperature**

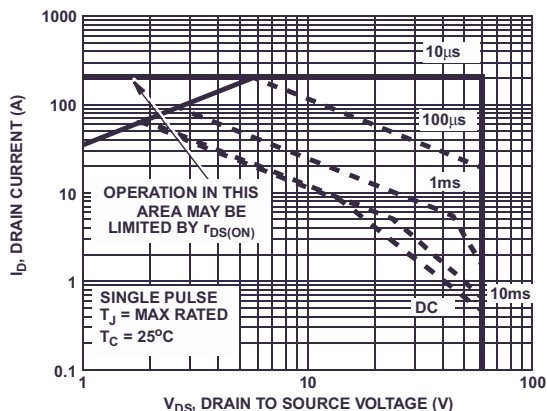


**Figure 3. Normalized Maximum Transient Thermal Impedance**

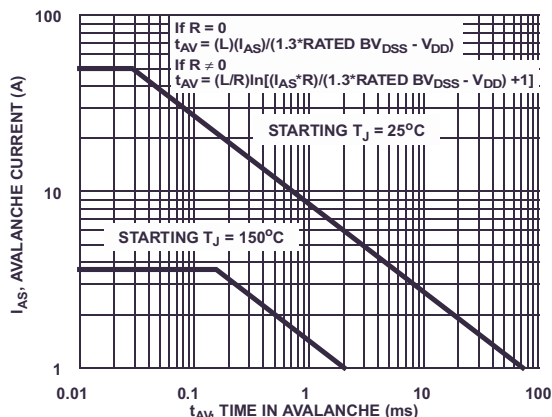


**Figure 4. Peak Current Capability**

**Typical Characteristics**  $T_C = 25^\circ\text{C}$  unless otherwise noted

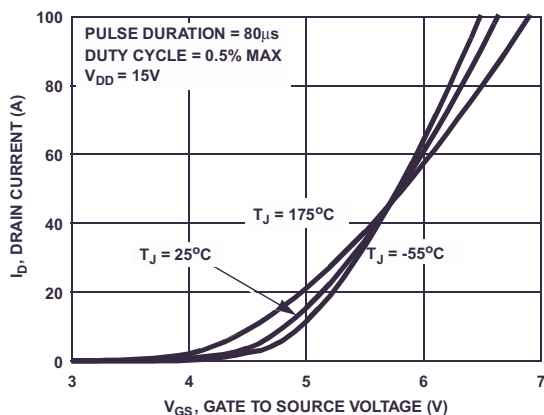


**Figure 5. Forward Bias Safe Operating Area**

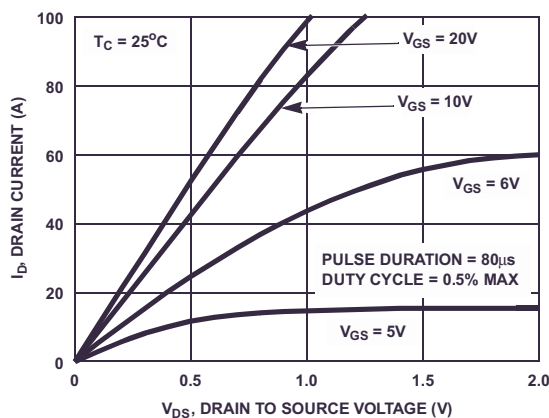


NOTE: Refer to ON Semiconductor Application Notes AN7514 and AN7515

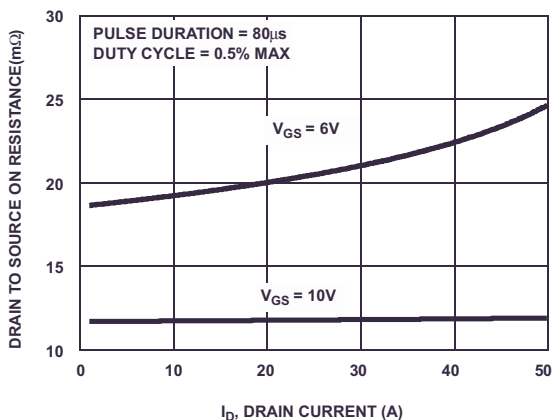
**Figure 6. Unclamped Inductive Switching Capability**



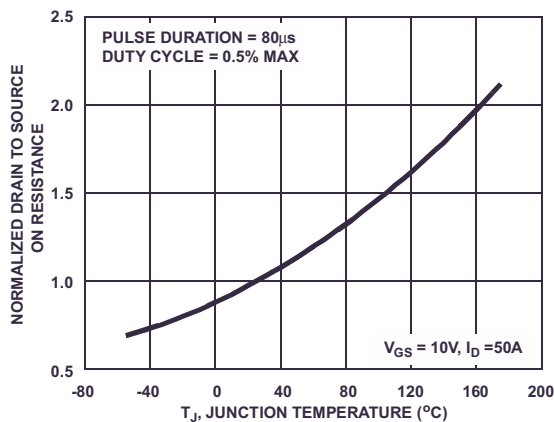
**Figure 7. Transfer Characteristics**



**Figure 8. Saturation Characteristics**

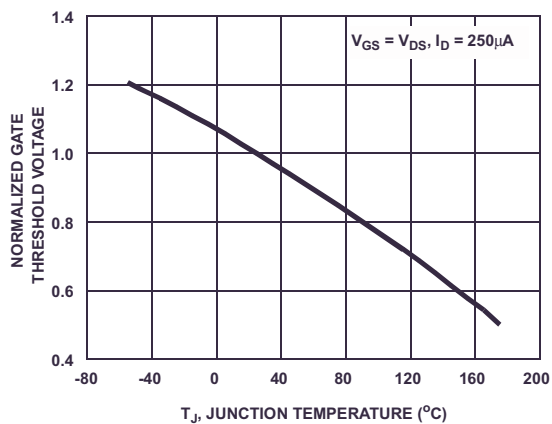


**Figure 9. Drain to Source On Resistance vs Drain Current**

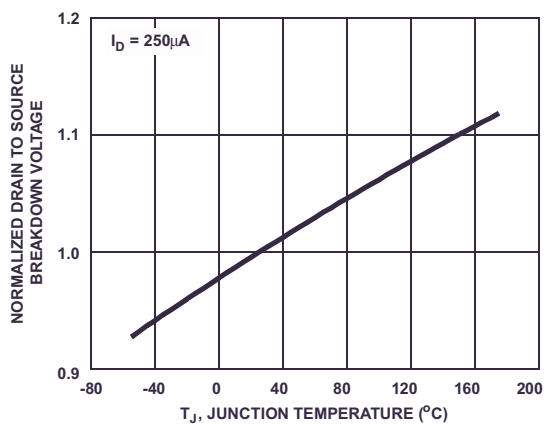


**Figure 10. Normalized Drain to Source On Resistance vs Junction Temperature**

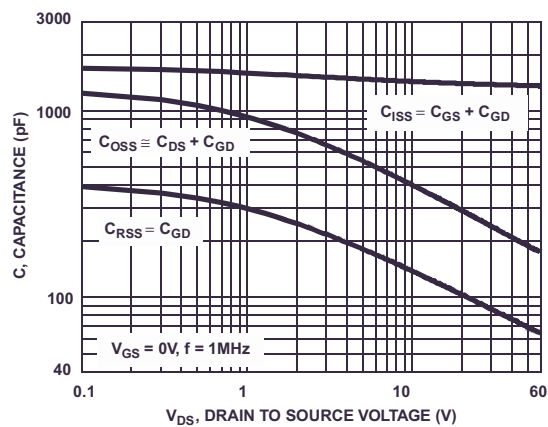
**Typical Characteristics**  $T_C = 25^\circ\text{C}$  unless otherwise noted



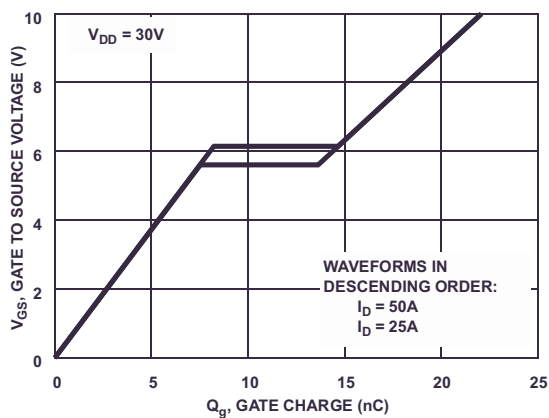
**Figure 11. Normalized Gate Threshold Voltage vs Junction Temperature**



**Figure 12. Normalized Drain to Source Breakdown Voltage vs Junction Temperature**



**Figure 13. Capacitance vs Drain to Source Voltage**



**Figure 14. Gate Charge Waveforms for Constant Gate Current**

### Test Circuits and Waveforms

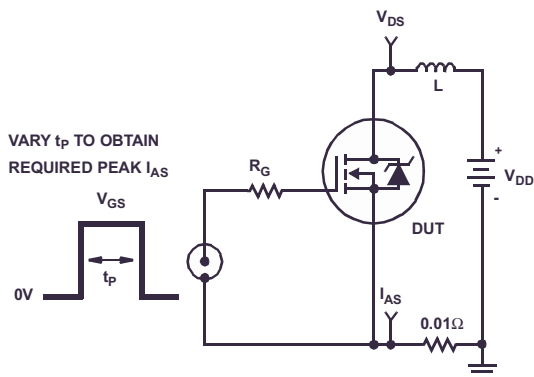


Figure 15. Unclamped Energy Test Circuit

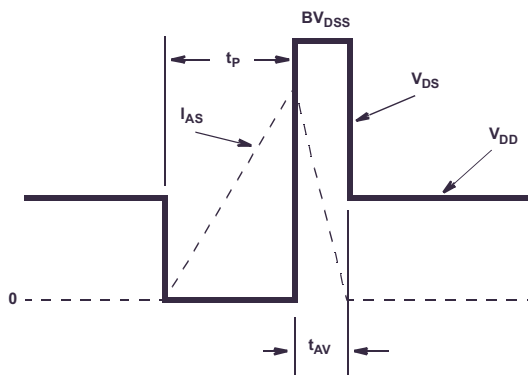


Figure 16. Unclamped Energy Waveforms

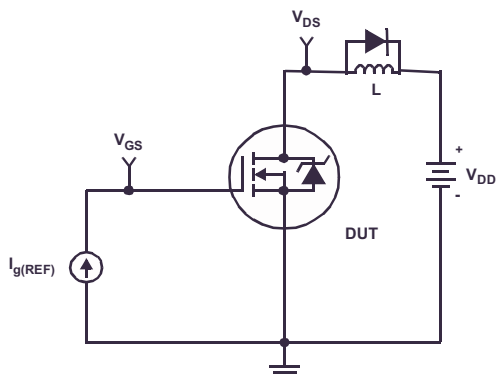


Figure 17. Gate Charge Test Circuit

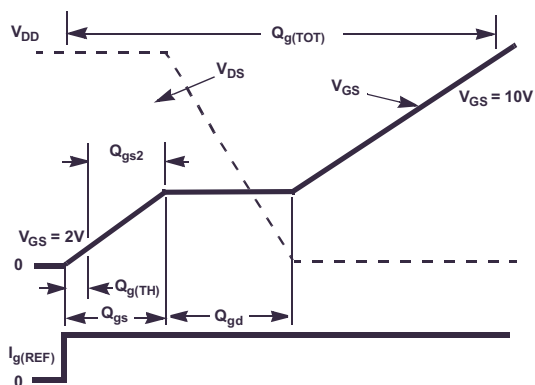


Figure 18. Gate Charge Waveforms

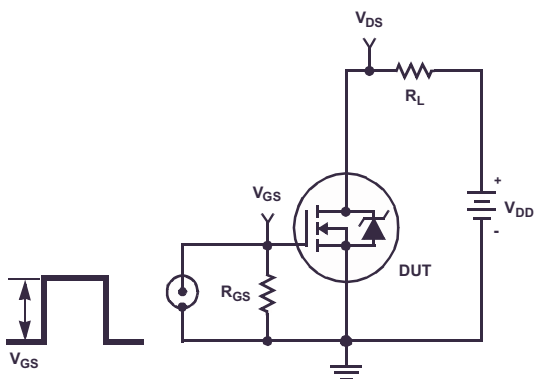


Figure 19. Switching Time Test Circuit

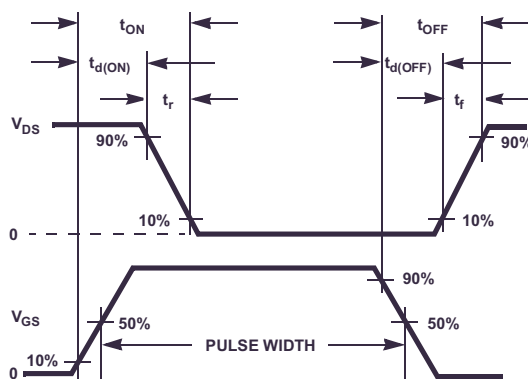


Figure 20. Switching Time Waveforms

### Thermal Resistance vs. Mounting Pad Area

The maximum rated junction temperature,  $T_{JM}$ , and the thermal resistance of the heat dissipating path determines the maximum allowable device power dissipation,  $P_{DM}$ , in an application. Therefore the application's ambient temperature,  $T_A$  ( $^{\circ}C$ ), and thermal resistance  $R_{\theta JA}$  ( $^{\circ}C/W$ ) must be reviewed to ensure that  $T_{JM}$  is never exceeded. Equation 1 mathematically represents the relationship and serves as the basis for establishing the rating of the part.

$$P_{DM} = \frac{(T_{JM} - T_A)}{R_{\theta JA}} \quad (\text{EQ. 1})$$

In using surface mount devices such as the TO-252 package, the environment in which it is applied will have a significant influence on the part's current and maximum power dissipation ratings. Precise determination of  $P_{DM}$  is complex and influenced by many factors:

1. Mounting pad area onto which the device is attached and whether there is copper on one side or both sides of the board.
2. The number of copper layers and the thickness of the board.
3. The use of external heat sinks.
4. The use of thermal vias.
5. Air flow and board orientation.
6. For non steady state applications, the pulse width, the duty cycle and the transient thermal response of the part, the board and the environment they are in.

ON Semiconductor provides thermal information to assist the designer's preliminary application evaluation. Figure 21

defines the  $R_{\theta JA}$  for the device as a function of the top copper (component side) area. This is for a horizontally positioned FR-4 board with 1oz copper after 1000 seconds of steady state power with no air flow. This graph provides the necessary information for calculation of the steady state junction temperature or power dissipation. Pulse applications can be evaluated using the ON Semiconductor device Spice thermal model or manually utilizing the normalized maximum transient thermal impedance curve.

Thermal resistances corresponding to other copper areas can be obtained from Figure 21 or by calculation using Equation 2 or 3. Equation 2 is used for copper area defined in inches square and equation 3 is for area in centimeters square. The area, in square inches or square centimeters is the top copper area including the gate and source pads.

$$R_{\theta JA} = 33.32 + \frac{23.84}{(0.268 + Area)} \quad (\text{EQ. 2})$$

Area in Inches Squared

$$R_{\theta JA} = 33.32 + \frac{154}{(1.73 + Area)} \quad (\text{EQ. 3})$$

Area in Centimeters Squared

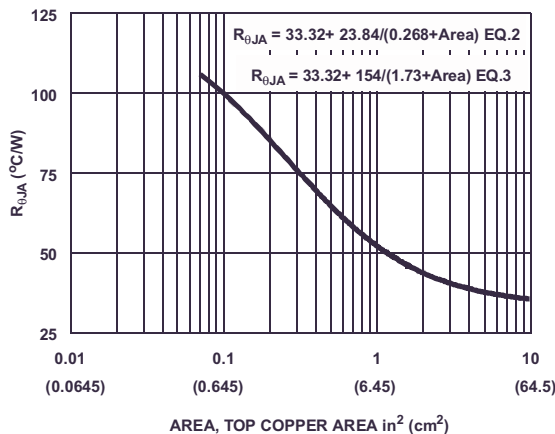


Figure 21. Thermal Resistance vs Mounting Pad Area



# SABER Electrical Model

rev August 2002  
 template FDD13AN06A0 n2,n1,n3  
 electrical n2,n1,n3

```

{
var i iscl
dp..model dbodymod = (isl=1.0e-11,nl=1.08,rs=3.5e-3,trs1=2.2e-3,trs2=2.5e-9,cjo=.9e-9,m=5.1e-1,tt=1e-9,xti=3.9)
dp..model dbreakmod = (rs=1.5e-1,trs1=1e-3,trs2=-8.9e-6)
dp..model dplcapmod = (cjo=4.1e-10,isl=10e-30,nl=10,m=0.45)
m..model mmedmod = (type=_n,vto=3.5,kp=6,is=1e-30,tox=1)
m..model mstrongmod = (type=_n,vto=4.3,kp=50,is=1e-30,tox=1)
m..model mweakmod = (type=_n,vto=2.91,kp=0.05,is=1e-30,tox=1,rs=0.1)
sw_vcsp..model s1amod = (ron=1e-5,roff=0.1,von=-5,voff=-2)
sw_vcsp..model s1bmod = (ron=1e-5,roff=0.1,von=-2,voff=-5)
sw_vcsp..model s2amod = (ron=1e-5,roff=0.1,von=-1.5,voff=.5)
sw_vcsp..model s2bmod = (ron=1e-5,roff=0.1,von=.5,voff=-1.5)
c.ca n12 n8 = 5.1e-10
c.cb n15 n14 = 5.8e-10
c.cin n6 n8 = 1.3e-9
  
```

```

dp.dbody n7 n5 = model=dbodymod
dp.dbreak n5 n11 = model=dbreakmod
dp.dplcap n10 n5 = model=dplcapmod
  
```

```

spe.ebreak n11 n7 n17 n18 = 65.40
spe.eds n14 n8 n5 n8 = 1
spe.egs n13 n8 n6 n8 = 1
spe.esg n6 n10 n6 n8 = 1
spe.evthres n6 n21 n19 n8 = 1
spe.evtemp n20 n6 n18 n22 = 1
  
```

```
i.it n8 n17 = 1
```

```

l.lgate n1 n9 = 5.2e-9
l.ldrain n2 n5 = 1.0e-9
l.lsource n3 n7 = 2.14e-9
  
```

```

res.rlgate n1 n9 = 52
res.rldrain n2 n5 = 10
res.rlsource n3 n7 = 21.4
  
```

```

m.mmed n16 n6 n8 n8 = model=mmedmod, l=1u, w=1u
m.mstrong n16 n6 n8 n8 = model=mstrongmod, l=1u, w=1u
m.mweak n16 n21 n8 n8 = model=mweakmod, l=1u, w=1u
  
```

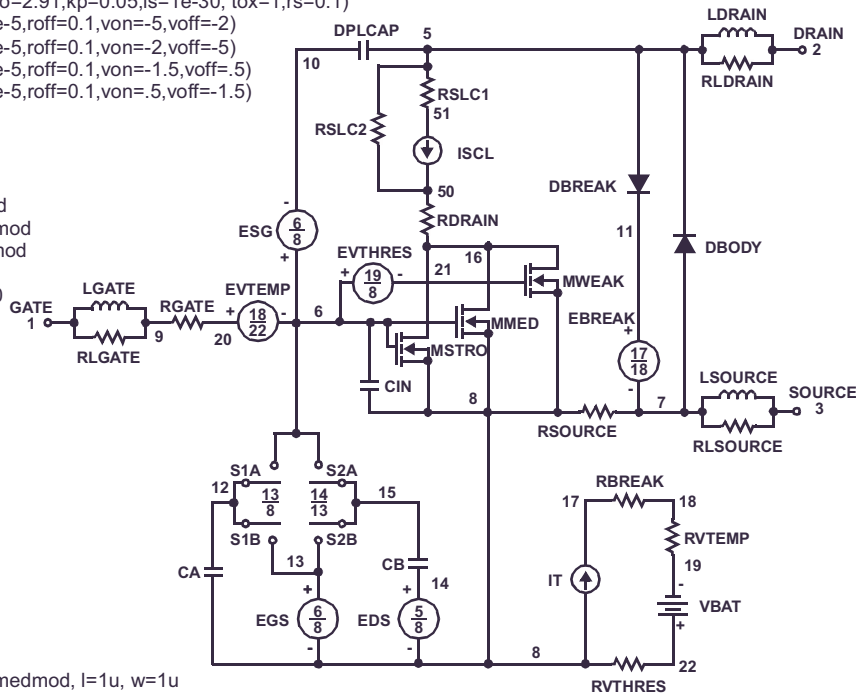
```

res.rbreak n17 n18 = 1, tc1=9e-4,tc2=-5e-7
res.rdrain n50 n16 = 3.1e-3, tc1=1.3e-2,tc2=5.2e-5
res.rgate n9 n20 = 3.71
res.rslc1 n5 n51 = 1e-6, tc1=1.8e-3,tc2=1.7e-5
res.rslc2 n5 n50 = 1e3
res.rsource n8 n7 = 5.5e-3, tc1=1e-3,tc2=1e-6
res.rvthres n22 n8 = 1, tc1=-5.3e-3,tc2=-1.0e-5
res.rvtemp n18 n19 = 1, tc1=-2.5e-3,tc2=1e-6
sw_vcsp.s1a n6 n12 n13 n8 = model=s1amod
sw_vcsp.s1b n13 n12 n13 n8 = model=s1bmod
sw_vcsp.s2a n6 n15 n14 n13 = model=s2amod
sw_vcsp.s2b n13 n15 n14 n13 = model=s2bmod
  
```

```
v.vbat n22 n19 = dc=1
```

```

equations {
i (n51->n50) += iscl
iscl: v(n51,n50) = (((v(n5,n51))/(1e-9+abs(v(n5,n51))))*((abs(v(n5,n51))*1e6/160)** 6))
}}
  
```



FDD13AN06A0-F085 N-Channel PowerTrench® MOSFET

### PSPICE Thermal Model

REV 22 August 2002

FDD13AN06A0T

CTHERM1 TH 6 9.7e-4  
 CTHERM2 6 5 6.2e-3  
 CTHERM3 5 4 4.6e-3  
 CTHERM4 4 3 4.9e-3  
 CTHERM5 3 2 8e-3  
 CTHERM6 2 TL 4.2e-2

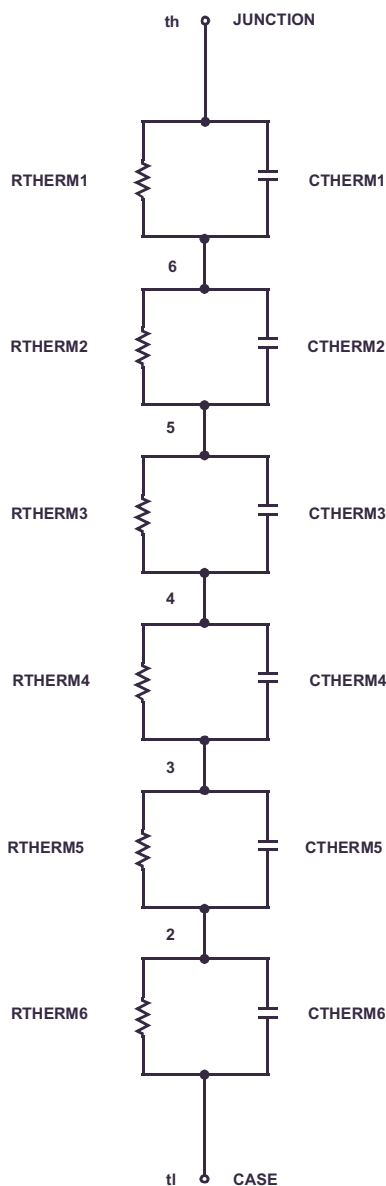
RTHERM1 TH 6 5.24e-2  
 RTHERM2 6 5 10.08e-2  
 RTHERM3 5 4 4.28e-1  
 RTHERM4 4 3 1.8e-1  
 RTHERM5 3 2 1.9e-1  
 RTHERM6 2 TL 2.1e-1

### SABER Thermal Model

SABER thermal model FDD13AN06A0T  
 template thermal\_model th tl  
 thermal\_c th, tl

```
{
ctherm.ctherm1 th 6 =9.7e-4
ctherm.ctherm2 6 5 =6.2e-3
ctherm.ctherm3 5 4 =4.6e-3
ctherm.ctherm4 4 3 =4.9e-3
ctherm.ctherm5 3 2 =8e-3
ctherm.ctherm6 2 tl =4.2e-2
```

```
rtherm.rtherm1 th 6 =5.24e-2
rtherm.rtherm2 6 5 =10.08e-2
rtherm.rtherm3 5 4 =4.28e-1
rtherm.rtherm4 4 3 =1.8e-1
rtherm.rtherm5 3 2 =1.9e-1
rtherm.rtherm6 2 tl =2.1e-1
}
```



ON Semiconductor and  are trademarks of Semiconductor Components Industries, LLC dba ON Semiconductor or its subsidiaries in the United States and/or other countries. ON Semiconductor owns the rights to a number of patents, trademarks, copyrights, trade secrets, and other intellectual property. A listing of ON Semiconductor's product/patent coverage may be accessed at [www.onsemi.com/site/pdf/Patent-Marking.pdf](http://www.onsemi.com/site/pdf/Patent-Marking.pdf). ON Semiconductor reserves the right to make changes without further notice to any products herein. ON Semiconductor makes no warranty, representation or guarantee regarding the suitability of its products for any particular purpose, nor does ON Semiconductor assume any liability arising out of the application or use of any product or circuit, and specifically disclaims any and all liability, including without limitation special, consequential or incidental damages. Buyer is responsible for its products and applications using ON Semiconductor products, including compliance with all laws, regulations and safety requirements or standards, regardless of any support or applications information provided by ON Semiconductor. "Typical" parameters which may be provided in ON Semiconductor data sheets and/or specifications can and do vary in different applications and actual performance may vary over time. All operating parameters, including "Typicals" must be validated for each customer application by customer's technical experts. ON Semiconductor does not convey any license under its patent rights nor the rights of others. ON Semiconductor products are not designed, intended, or authorized for use as a critical component in life support systems or any FDA Class 3 medical devices or medical devices with a same or similar classification in a foreign jurisdiction or any devices intended for implantation in the human body. Should Buyer purchase or use ON Semiconductor products for any such unintended or unauthorized application, Buyer shall indemnify and hold ON Semiconductor and its officers, employees, subsidiaries, affiliates, and distributors harmless against all claims, costs, damages, and expenses, and reasonable attorney fees arising out of, directly or indirectly, any claim of personal injury or death associated with such unintended or unauthorized use, even if such claim alleges that ON Semiconductor was negligent regarding the design or manufacture of the part. ON Semiconductor is an Equal Opportunity/Affirmative Action Employer. This literature is subject to all applicable copyright laws and is not for resale in any manner.

## PUBLICATION ORDERING INFORMATION

### LITERATURE FULFILLMENT:



Literature Distribution Center for ON Semiconductor  
19521 E. 32nd Pkwy, Aurora, Colorado 80011 USA  
**Phone:** 303-675-2175 or 800-344-3860 Toll Free USA/Canada  
**Fax:** 303-675-2176 or 800-344-3867 Toll Free USA/Canada  
**Email:** [orderlit@onsemi.com](mailto:orderlit@onsemi.com)

**N. American Technical Support:** 800-282-9855 Toll Free  
USA/Canada  
**Europe, Middle East and Africa Technical Support:**  
Phone: 421 33 790 2910  
**Japan Customer Focus Center**  
Phone: 81-3-5817-1050

**ON Semiconductor Website:** [www.onsemi.com](http://www.onsemi.com)  
**Order Literature:** <http://www.onsemi.com/orderlit>  
For additional information, please contact your local  
Sales Representative

## Looking for pricing, stock, or lifecycle information?

Click below to explore more details on WIN SOURCE:

-  [View FDD13AN06A0-F085 on WIN SOURCE](#)
-  [ON Semiconductor](#) Information

## Optimize Your Supply Chain with WIN SOURCE Solutions

-  Global Sourcing Solution
-  Obsolete Management
-  Cost Control Management
-  Shortage Management
-  Alternative Solution
-  Excess Inventory Management