



THE DATASHEET OF FFM201-W



**SURFACE MOUNT GLASS PASSIVATED
FAST RECOVERY SILICON RECTIFIER**
VOLTAGE RANGE 50 to 1000 Volts CURRENT 2.0 Amperes

FEATURES

- * Glass passivated device
- * Ideal for surface mounted applications
- * Low leakage current
- * Metallurgically bonded construction
- * Mounting position: Any
- * Weight: 0.098 gram
- * P/N suffix V means AEC-Q101 qualified, e.g:FFM201V
- * P/N suffix V means Halogen-free

MECHANICAL DATA

- * Epoxy : Device has UL flammability classification 94V-0

MAXIMUM RATINGS AND ELECTRICAL CHARACTERISTICS

Ratings at 25 °C ambient temperature unless otherwise specified.
Single phase, half wave, 60 Hz, resistive or inductive load.
For capacitive load, derate current by 20%.



DO-214AA

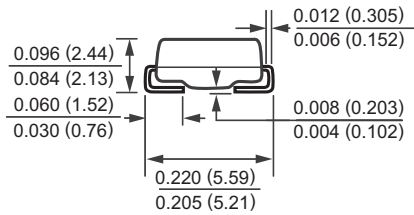
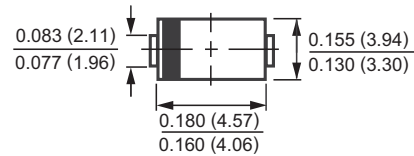

Dimensions in inches and (millimeters)

MAXIMUM RATINGS (At TA = 25°C unless otherwise noted)

RATINGS	SYMBOL	FFM201	FFM202	FFM203	FFM204	FFM205	FFM206	FFM207	UNITS
Maximum Recurrent Peak Reverse Voltage	VRRM	50	100	200	400	600	800	1000	Volts
Maximum RMS Voltage	VRMS	35	70	140	280	420	560	700	Volts
Maximum DC Blocking Voltage	Vdc	50	100	200	400	600	800	1000	Volts
Maximum Average Forward Rectified Current at TA = 55°C	Io	2.0							Amps
Peak Forward Surge Current 8.3 ms single half sine-wave superimposed on rated load (JEDEC method)	IFSM	60							Amps
Typical Current Squared Time	I ² T	15							A ² S
Maximum Thermal Resistance	(Note 2) RθJL	20							°C/W
	(Note 3) RθJA	60							°C/W
Typical Junction Capacitance (Note 1)	CJ	50							pF
Operating and Storage Temperature Range	TJ, TSTG	-55 to + 150							°C

ELECTRICAL CHARACTERISTICS (At TA = 25°C unless otherwise noted)

CHARACTERISTICS	SYMBOL	FFM201	FFM202	FFM203	FFM204	FFM205	FFM206	FFM207	UNITS	
Maximum Forward Voltage at 2.0A DC	VF					1.3				Volts
Maximum Full Load Reverse Current, Full cycle Average at TA=55°C						20				uAmps
Maximum DC Reverse Current at	@TA = 25°C					2.0				uAmps
	Rated DC Blocking Voltage	@TA = 150°C					2.0			
Maximum Reverse Recovery Time (Note 4)	trr	150			250		500		nSec	

- NOTES : 1. Measured at 1.0 MHz and applied average voltage of 4.0VDC
 2. Thermal resistance junction to terminal 6.0mm² copper pads to each terminal.
 3. Thermal resistance junction to ambient, 6.0mm² copper pads to each terminal.
 4. Test Conditions: IF = 0.5A, IR = -1.0A, IRR = -0.25A

RATING AND CHARACTERISTIC CURVES (FFM201 THRU FFM207)

FIG. 1 - TYPICAL FORWARD CURRENT DERATING CURVE

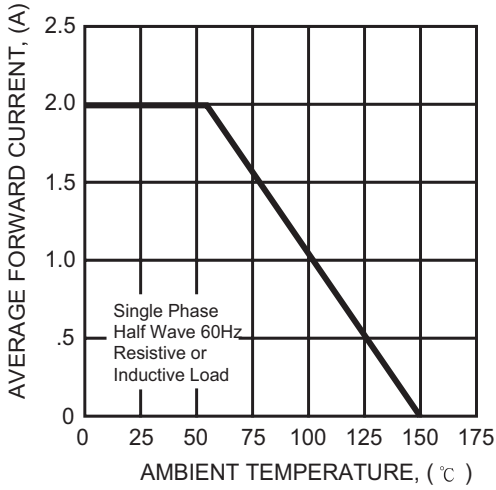

FIG. 2 - MAXIMUM NON-REPETITIVE FORWARD SURGE CURRENT

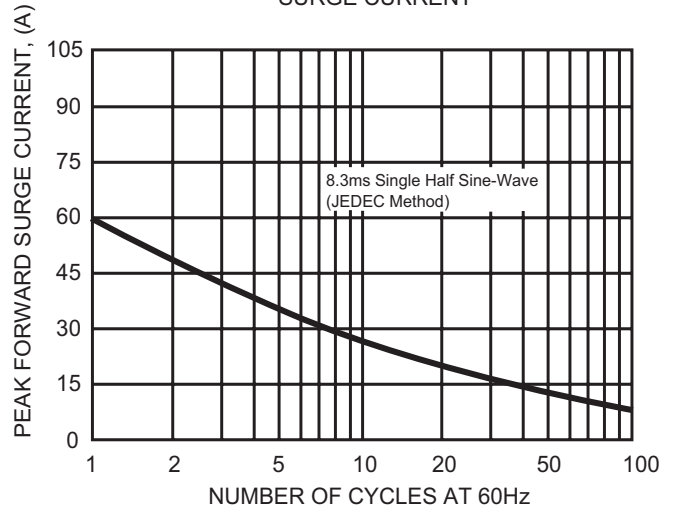

FIG. 3 - MAXIMUM INSTANTANEOUS FORWARD CHARACTERISTICS

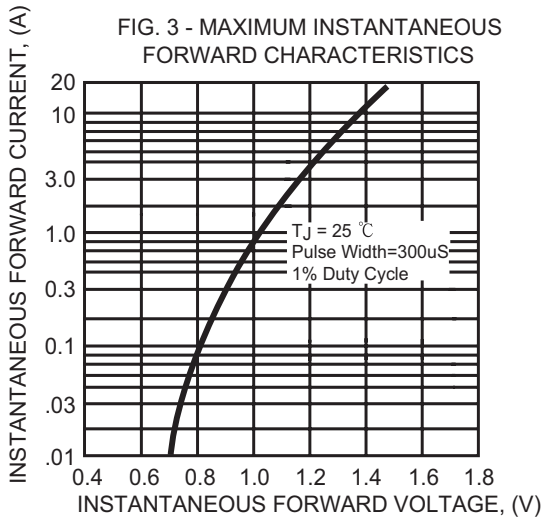

FIG. 4 - TYPICAL JUNCTION CAPACITANCE

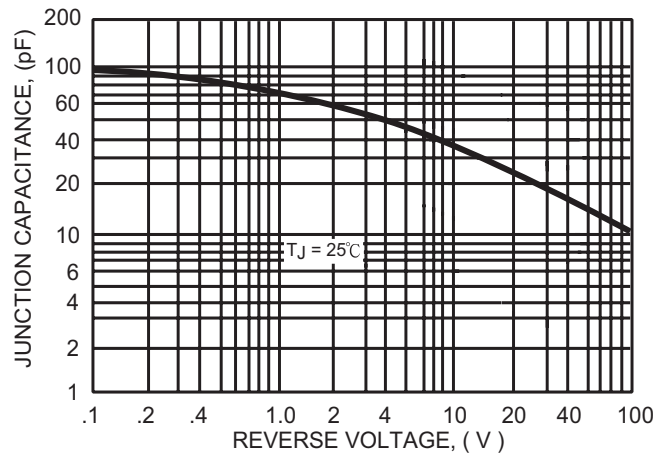
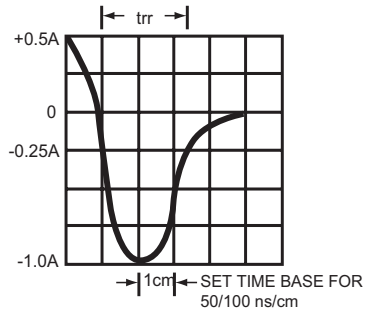
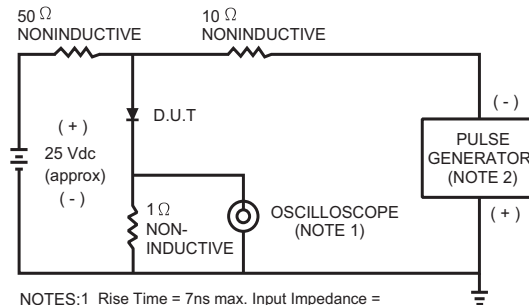
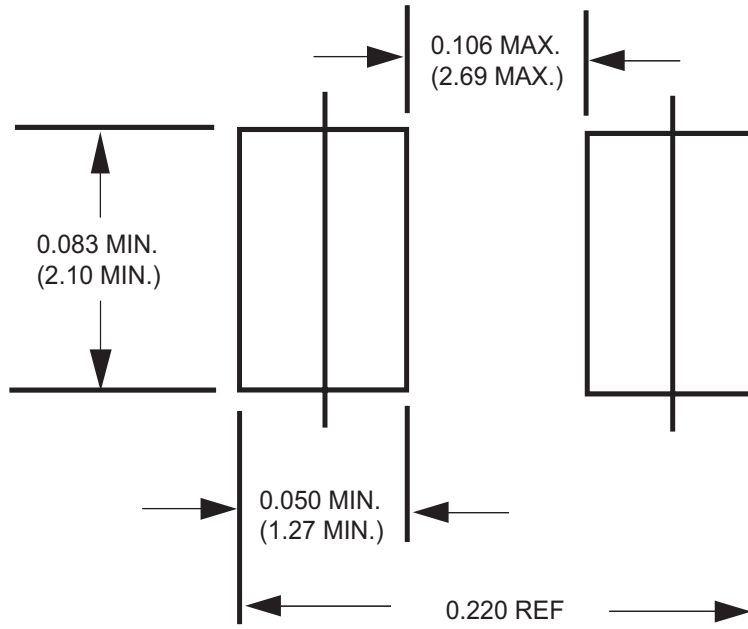

FIG. 5 - TEST CIRCUIT DIAGRAM AND REVERSE RECOVERY TIME CHARACTERISTIC



Mounting Pad Layout



Dimensions in inches and (millimeters)

PACKAGING OF DIODE AND BRIDGE RECTIFIERS

REEL PACK

PACKAGE	PACKING CODE	EA PER REEL	EA PER INNER BOX	COMPONENT SPACE (mm)	TAPE SPACE (mm)	REEL DIA (mm)	CARTON SIZE (mm)	EA PER CARTON	GROSS WEIGHT(Kg)
SMB	-W/T	3,000	6,000	---	---	330	360*355*360	48,000	13.90



Attachment information about FFM20X

1. Internal Circuit



2. Marking on the body

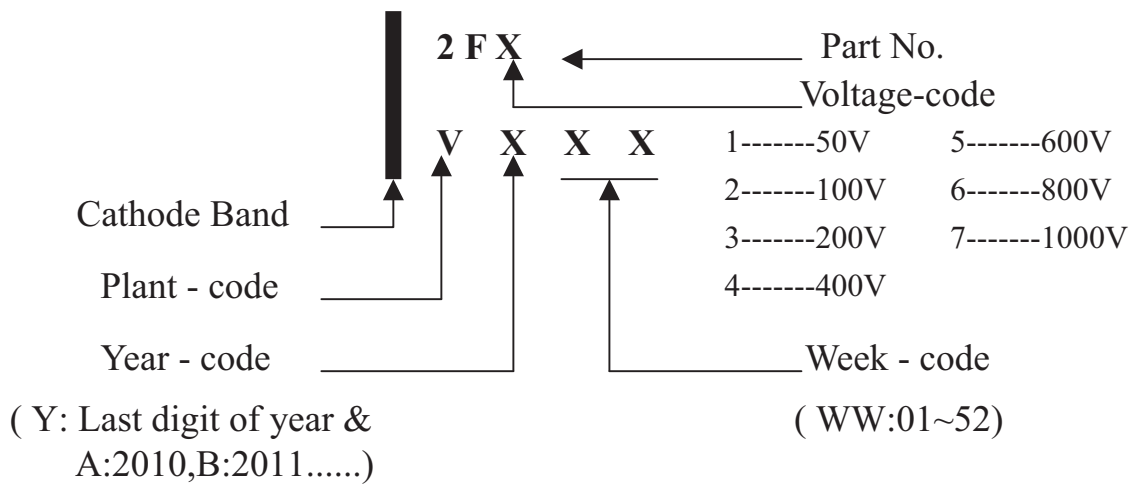



Attachment information about FFM20X

3. Items marked on the reel box and carton

3.1 On the reel (for -T & -W)

CUSTOMER

TYPE

QUANTITY

LOT NO.

Q.A.

REMARK

3.2 On the box (for -T & -W)

TYPE

QUANTITY

LOT NO.

Q.A.

3.3 On the carton

CUSTOMER

TYPE

QUANTITY

LOT NO.

REMARK

1. BOX

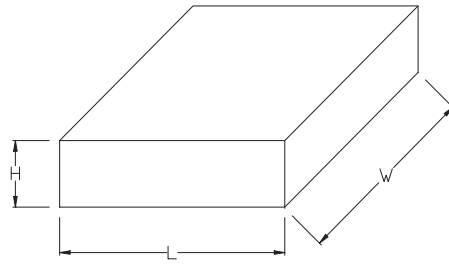

Packing Code	L (mm)	W (mm)	H (mm)
-W/-T	338	338	40

2. REEL

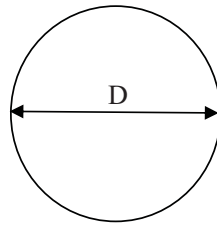

Packing Code	D (mm)
-W/-T	330

3. CARTON

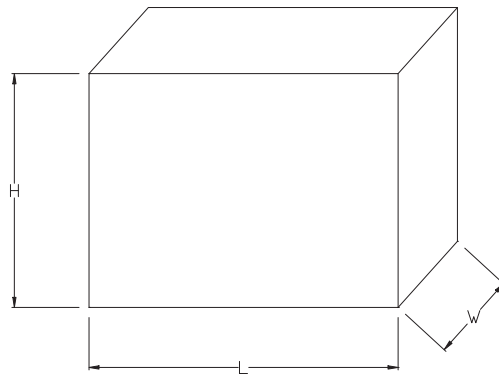

Packing Code	L (mm)	W (mm)	H (mm)
-W/-T	360	355	360



DISCLAIMER NOTICE

Rectron Inc reserves the right to make changes without notice to any product specification herein, to make corrections, modifications, enhancements or other changes. Rectron Inc or anyone on its behalf assumes no responsibility or liability for any errors or inaccuracies. Data sheet specifications and its information contained are intended to provide a product description only. "Typical" parameters which may be included on RECTRON data sheets and/ or specifications can and do vary in different applications and actual performance may vary over time. Rectron Inc does not assume any liability arising out of the application or use of any product or circuit.

Rectron products are not designed, intended or authorized for use in medical, life-saving implant or other applications intended for life-sustaining or other related applications where a failure or malfunction of component or circuitry may directly or indirectly cause injury or threaten a life without expressed written approval of Rectron Inc. Customers using or selling Rectron components for use in such applications do so at their own risk and shall agree to fully indemnify Rectron Inc and its subsidiaries harmless against all claims, damages and expenditures.

Looking for pricing, stock, or lifecycle information?

Click below to explore more details on WIN SOURCE:

-  [View FFM201-W on WIN SOURCE](#)
-  [Rectron USA Information](#)

Optimize Your Supply Chain with WIN SOURCE Solutions

-  Global Sourcing Solution
-  Obsolete Management
-  Cost Control Management
-  Shortage Management
-  Alternative Solution
-  Excess Inventory Management