



**THE DATASHEET OF
BD6112FVM-TR**



● Recommended Operating Conditions (Ta=25°C)

Parameter	Symbol	Min.	Typ.	Max.	Unit
Power supply voltage	V _{BAT}	2.5	3.6	5.5	V

● Electrical characteristics (Unless otherwise noted; Ta=25°C, V_{BAT}=3.6V, STBY=3.6V)

Parameter	Symbol	Min.	Typ.	Max.	Unit	Conditions	
Circuit current	I _{Q1}	–	0.5	3	mA	No load, V _{IN} =1.25V	
Stand-by current	I _{Q2}	–	–	5	μA	No load, V _{IN} =0V, STBY=0V	
<Regulator block>							
Output voltage 1	V _O	–2.1	–2.0	–1.9	V	V _{IN} =1.25V, I _{OUT} =5mA	
Output voltage 2	V _{O2}	V _O x 0.95	V _O	V _O x 1.05	V	V _{IN} =0.5~1.8V, V _O =–1.6 x V _{IN} , I _{OUT} =5mA	
Output ripple voltage	V _{RR}	–	–70	–60	dBV	V _{IN} =1.25V, I _{OUT} =5mA	
Maximum output current	I _{OMAX}	10	–	–	mA	V _{IN} =1.25V, V _{OUT} ≤V _O +0.1V	
Load regulation	ΔV _{OL}	–	2	40	mV	V _{IN} =1.25V, I _o =0~5mA	
Line regulation	ΔV _{OI}	–	10	40	mV	V _{BAT} =3.0~6.0V, I _o =5mA	
V _{IN} pin inflow current	I _{IN}	–	0	2	μA	V _{IN} =1.25V	
<Charge-pump block>							
Oscillation frequency	f _{osc}	–	120	–	kHz		
Voltage conversion efficiency	V _{CE}	–	97	–	%	No load, NEGOUT monitor	
Stand-by pin pull down resistance	R _{STBY}	0.6	1.0	1.6	MΩ		
Stand-by pin control voltage	Operating	V _{IH}	2.0	–	–	V	
	Non-operating	V _{IL}	–0.3	–	0.3	V	

● Application Circuit

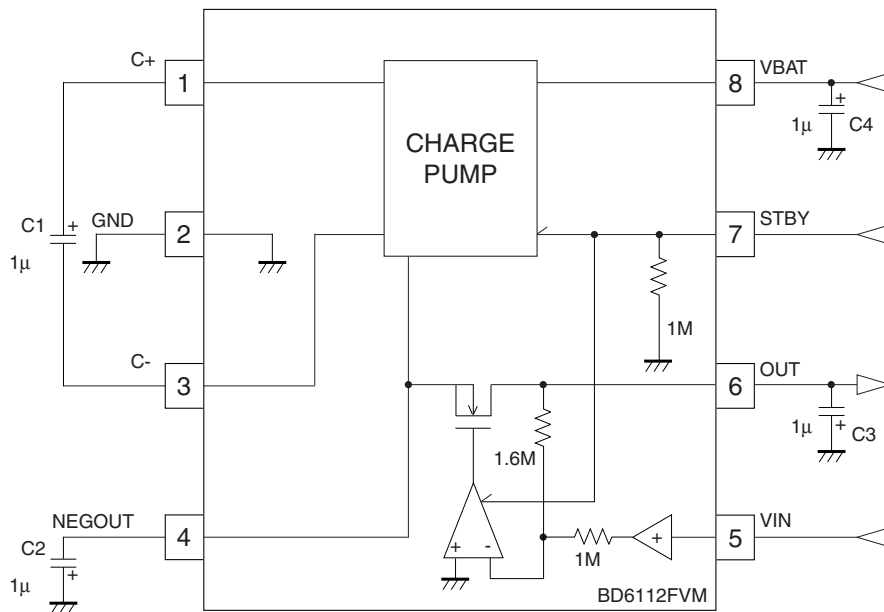

Notes

- No technical content pages of this document may be reproduced in any form or transmitted by any means without prior permission of ROHM CO.,LTD.
- The contents described herein are subject to change without notice. The specifications for the product described in this document are for reference only. Upon actual use, therefore, please request that specifications to be separately delivered.
- Application circuit diagrams and circuit constants contained herein are shown as examples of standard use and operation. Please pay careful attention to the peripheral conditions when designing circuits and deciding upon circuit constants in the set.
- Any data, including, but not limited to application circuit diagrams information, described herein are intended only as illustrations of such devices and not as the specifications for such devices. ROHM CO.,LTD. disclaims any warranty that any use of such devices shall be free from infringement of any third party's intellectual property rights or other proprietary rights, and further, assumes no liability of whatsoever nature in the event of any such infringement, or arising from or connected with or related to the use of such devices.
- Upon the sale of any such devices, other than for buyer's right to use such devices itself, resell or otherwise dispose of the same, no express or implied right or license to practice or commercially exploit any intellectual property rights or other proprietary rights owned or controlled by
- ROHM CO., LTD. is granted to any such buyer.
- Products listed in this document use silicon as a basic material.
Products listed in this document are no antiradiation design.

The products listed in this document are designed to be used with ordinary electronic equipment or devices (such as audio visual equipment, office-automation equipment, communications devices, electrical appliances and electronic toys).

Should you intend to use these products with equipment or devices which require an extremely high level of reliability and the malfunction of which would directly endanger human life (such as medical instruments, transportation equipment, aerospace machinery, nuclear-reactor controllers, fuel controllers and other safety devices), please be sure to consult with our sales representative in advance.

About Export Control Order in Japan

Products described herein are the objects of controlled goods in Annex 1 (Item 16) of Export Trade Control Order in Japan.







In case of export from Japan, please confirm if it applies to "objective" criteria or an "informed" (by MITI clause) on the basis of "catch all controls for Non-Proliferation of Weapons of Mass Destruction.

Looking for pricing, stock, or lifecycle information?

Click below to explore more details on WIN SOURCE:

-  [View BD6112FVM-TR on WIN SOURCE](#)
-  [Rohm Semiconductor Information](#)

Optimize Your Supply Chain with WIN SOURCE Solutions

-  Global Sourcing Solution
-  Obsolete Management
-  Cost Control Management
-  Shortage Management
-  Alternative Solution
-  Excess Inventory Management