

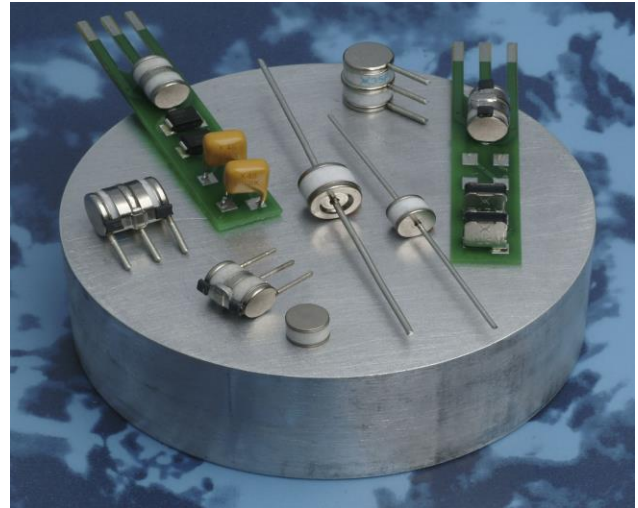

## Gas Discharge Tubes GTCX25-XXXM-R02 Series

Littelfuse Circuit Protection 5mm 2Pole GDTs (ceramic gas discharge tubes), are commonly used to help protect sensitive telecom equipment such as communication lines, signal lines and data transmission lines from damage caused by transient surge voltages that typically result from lightning strikes and equipment switching operations.

Littelfuse Circuit Protection GDTs offer a high level of surge protection, low capacitance and a broad array of breakover voltage levels, making them suitable for applications such as MDF (Main Distribution Frame) modules, high data-rate telecom applications (e.g. ADSL, VDSL), and surge protection on power lines. Littelfuse Circuit Protection GDTs, can help equipment meet the most stringent regulatory standards.



### Benefits:

- Compact, small form factor suitable for efficient assembly
- Helps provide overvoltage fault protection against high energy surges
- Suitable for high-frequency applications

### Features:

- 2Pole, 5mm devices
- Broad voltage range from 75V-600V
- Various form factors: surface mount, axial leads, no leads
- Low capacitance and insertion loss
- UL 497B recognized
- RoHS compliant
- Devices tested per ITU K.12 recommendations
- Non-radioactive materials

### Applications:

- Telecommunications
  - MDF modules, xDSL equipment, RF system protection, antenna, base station
- Industrial and consumer electronics, such as
  - Surge protectors
  - Alarm system

# Gas Discharge Tubes

## GTCX25-XXXM-R02 Series

### Device Voltage Ratings and Part Marking

Part Number	DC Sparkover	Impulse Sparkover		DC Holdover Voltage	On-State Voltage
	@100V/s ±20% Tolerance (V)	@100 V/μs (V)	@1000 V/μs (V)	Per ITU K.12 (<150ms) (V)	Nominal (@ 1A) (V)
GTCX25-750M-R02	75	450	550	<52	20
GTCX25-900M-R02	90	450	550	<52	20
GTCX25-141M-R02	140	500	600	<80	20
GTCX25-151M-R02	150	500	600	<80	20
GTCX25-201M-R02	200	600	700	<135	20
GTCX25-231M-R02	230	600	700	<135	20
GTCX25-251M-R02	250	600	700	<135	20
GTCX25-261M-R02	260	700	800	<135	20
GTCX25-301M-R02	300	800	900	<150	20
GTCX25-351M-R02	350	900	1000	<150	20
GTCX25-401M-R02	400	900	1000	<150	20
GTCX25-421M-R02	420	900	1000	<150	20
GTCX25-471M-R02	470	1050	1150	<150	20
GTCX25-501M-R02	500	1100	1200	<150	20
GTCX25-551M-R02	550	1300	1400	<150	20
GTCX25-601M-R02	600	1300	1400	<150	20

### Device Surge Rating, Capacitance, Insulation Resistance, UL

Part Number	Impulse Discharge Current	Impulse Life	AC Discharge Current (1sec duration; 10 hits)	Capacitance	Insulation Resistance	UL Rating
	8x20μs 10 hits	10x1000μs 300 hits	@50 Hz	@1Mhz	@100V*	UL497B #E179610
GTCX25-xxxM-R02	2.5kA	100A	2.5Arms	<1pF	10,000 (MΩ)	All Devices

Devices <=90V measured @ 50V  
 Devices >=500V measured @ 250V

## GTCX25-XXXM-R02 Series

### Product Dimensions

**DIMENSIONS = MILLIMETERS [INCHES]**

#### Surface-mount (GTCS25-XXXM-R02)

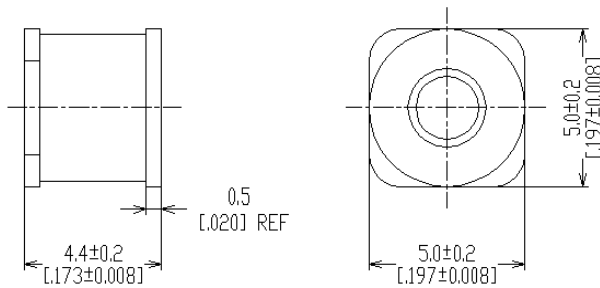

#### No Leads (GTCN25-XXXM-R02)

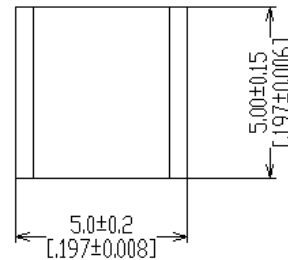

#### Axial Leads (GTCA25-XXXM-R02)

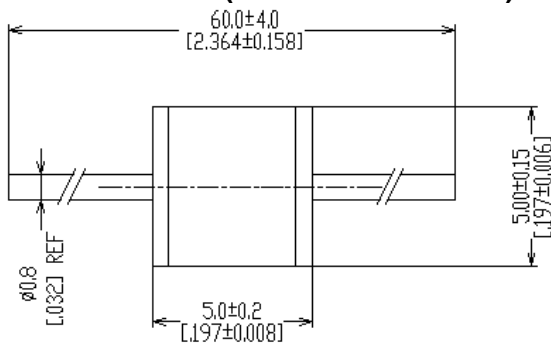

### Pad Layout – Surface-mount Devices (GTCS25-XXXM-R02)

	X	Y	Z
	NOM	NOM	NOM
mm:	6.0	3.9	1.3
in*:	(0.197)	(0.154)	(0.051)

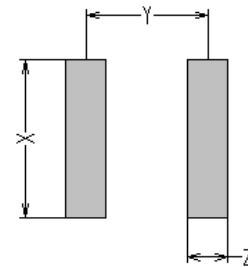

## GTCX25-XXXM-R02 Series

### General Characteristics

No Radioactive Material

Storage Temperature: -40°C to +90°C

Operating Temperature: -40°C to +90°C

Body: Nickel Plated

Leads: Surface-mount, Axial Devices: Tin Plated

Devices with No Leads: Nickel Plated

*Soldering Note: Devices with no leads are non-solderable; meant for insertion into magazine clips*

### Packaging Information

Part Description	Tray / Reel	Standard Package
No Leads: GTCN25-XXXM-R02	200pcs	5,000pcs
Axial Leads: GTCA25-XXXM-R02	100pcs	1,000pcs
Surface-mount: GTCX25-XXXM-R02	1,500pcs (Reel)	12,000pcs

### Part Numbering System

#### Example Part Number: GTCX25-351M-R02

GT = Gas Tube

C = Ceramic

X = Lead Configuration: **N**= No leads; **A**= Axial Leads; **S**= Surface-mount

2 = 2 Electrode device

5 = 5mm Diameter

351 = DC Spark Over Voltage of 350V (at 100V/s)

M = Tolerance of 20% on DC Spark Over Voltage

R = Product Family Designator

02 = Surge rating: 8x20µs 2.5kA 10 times

# Gas Discharge Tubes

## Part Marking Reference



### Example Part Marking: **⌘ 35 R02 GN**

<b>⌘</b> =	Manufacture Mark
<b>35</b> =	Voltage Designator (35 = 350V)
<b>R02</b> =	Product Family Designator + Surge Current 2.5kA (8x20μs 10 hits)
<b>GN</b> =	Year and Week of Manufacture

Littelfuse products are not designed for, and shall not be used for, any purpose (including, without limitation, automotive, military, aerospace, medical, life-saving, life-sustaining or nuclear facility applications, devices intended for surgical implant into the body, or any other application in which the failure or lack of desired operation of the product may result in personal injury, death, or property damage) other than those expressly set forth in applicable Littelfuse product documentation. Warranties granted by Littelfuse shall be deemed void for products used for any purpose not expressly set forth in applicable Littelfuse documentation. Littelfuse shall not be liable for any claims or damages arising out of products used in applications not expressly intended by Littelfuse as set forth in applicable Littelfuse documentation. The sale and use of Littelfuse products is subject to Littelfuse Terms and Conditions of Sale, unless otherwise agreed by Littelfuse.

## Looking for pricing, stock, or lifecycle information?

Click below to explore more details on WIN SOURCE:

-  [View GTCA25-501M-R02 on WIN SOURCE](#)
-  [Littelfuse Inc. Information](#)

## Optimize Your Supply Chain with WIN SOURCE Solutions

-  Global Sourcing Solution
-  Obsolete Management
-  Cost Control Management
-  Shortage Management
-  Alternative Solution
-  Excess Inventory Management