



# THE DATASHEET OF IRFZ34NSTRR



# IRFZ34NSPbF IRFZ34NLPbF

HEXFET® Power MOSFET

- Advanced Process Technology
- Surface Mount (IRFZ34NS)
- Low-profile through-hole (IRFZ34NL)
- 175°C Operating Temperature
- Fast Switching
- Fully Avalanche Rated
- Lead-Free

## Description

Fifth Generation HEXFETs from International Rectifier utilize advanced processing techniques to achieve extremely low on-resistance per silicon area. This benefit, combined with the fast switching speed and ruggedized device design that HEXFET Power MOSFETs are well known for, provides the designer with an extremely efficient and reliable device for use in a wide variety of applications.

The D<sup>2</sup>Pak is a surface mount power package capable of accommodating die sizes up to HEX-4. It provides the highest power capability and the lowest possible on-resistance in any existing surface mount package. The D<sup>2</sup>Pak is suitable for high current applications because of its low internal connection resistance and can dissipate up to 2.0W in a typical surface mount application.

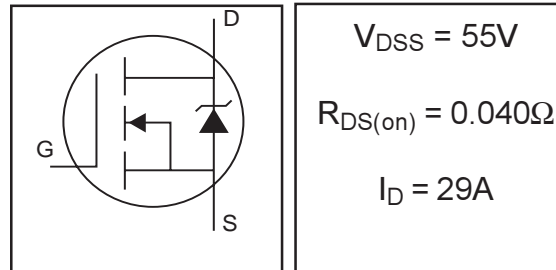
The through-hole version (IRFZ34NL) is available for low-profile applications.

## Absolute Maximum Ratings

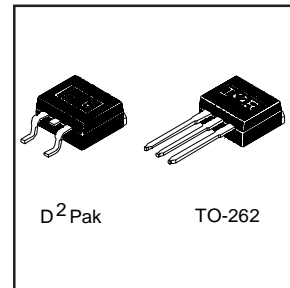
|                                 | Parameter   | Max.                   | Units |
|---------------------------------|---|------------------------|-------|
| $I_D @ T_C = 25^\circ\text{C}$  | Continuous Drain Current, $V_{GS} @ 10\text{V} \textcircled{5}$ | 29                     | A     |
| $I_D @ T_C = 100^\circ\text{C}$ | Continuous Drain Current, $V_{GS} @ 10\text{V} \textcircled{5}$ | 20                     |       |
| $I_{DM}$                        | Pulsed Drain Current $\textcircled{1} \textcircled{5}$          | 100                    |       |
| $P_D @ T_A = 25^\circ\text{C}$  | Power Dissipation   | 3.8                    | W     |
| $P_D @ T_C = 25^\circ\text{C}$  | Power Dissipation   | 68                     | W     |
|                                 | Linear Derating Factor  | 0.45                   | W/°C  |
| $V_{GS}$                        | Gate-to-Source Voltage  | $\pm 20$               | V     |
| $E_{AS}$                        | Single Pulse Avalanche Energy $\textcircled{2} \textcircled{5}$ | 130                    | mJ    |
| $I_{AR}$                        | Avalanche Current $\textcircled{4}$                             | 16                     | A     |
| $E_{AR}$                        | Repetitive Avalanche Energy $\textcircled{4}$                   | 5.6                    | mJ    |
| dv/dt                           | Peak Diode Recovery dv/dt $\textcircled{3} \textcircled{5}$     | 5.0                    | V/ns  |
| $T_J$                           | Operating Junction and  | -55 to + 175           | °C    |
| $T_{STG}$                       | Storage Temperature Range                                       |                        |       |
|                                 | Soldering Temperature, for 10 seconds                           | 300 (1.6mm from case ) |       |

## Thermal Resistance

|                 | Parameter                          | Typ. | Max. | Units |
|-----------------|------------------------------------|------|------|-------|
| $R_{\theta JC}$ | Junction-to-Case                   | ---  | 2.2  | °C/W  |
| $R_{\theta JA}$ | Junction-to-Ambient (PCB mount) ** | ---  | 40   |       |



|                            |
|----------------------------|
| $V_{DSS} = 55\text{V}$     |
| $R_{DS(on)} = 0.040\Omega$ |
| $I_D = 29\text{A}$         |



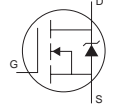
# IRFZ34NS/LPbF

International  
IR Rectifier

## Electrical Characteristics @ $T_J = 25^\circ\text{C}$ (unless otherwise specified)

|                                 | Parameter                            | Min. | Typ.  | Max.  | Units    | Conditions   |
|---------------------------------|--------------------------------------|------|-------|-------|----------|--|
| $V_{(BR)DSS}$                   | Drain-to-Source Breakdown Voltage    | 55   | —     | —     | V        | $V_{GS} = 0V, I_D = 250\mu A$                          |
| $\Delta V_{(BR)DSS}/\Delta T_J$ | Breakdown Voltage Temp. Coefficient  | —    | 0.052 | —     | V/°C     | Reference to $25^\circ\text{C}$ , $I_D = 1\text{mA}$ Ⓞ |
| $R_{DS(ON)}$                    | Static Drain-to-Source On-Resistance | —    | —     | 0.040 | $\Omega$ | $V_{GS} = 10V, I_D = 16A$ Ⓞ                            |
| $V_{GS(th)}$                    | Gate Threshold Voltage               | 2.0  | —     | 4.0   | V        | $V_{DS} = V_{GS}, I_D = 250\mu A$                      |
| $g_{fs}$                        | Forward Transconductance             | 6.5  | —     | —     | S        | $V_{DS} = 25V, I_D = 16A$                              |
| $I_{DSS}$                       | Drain-to-Source Leakage Current      | —    | —     | 25    | $\mu A$  | $V_{DS} = 55V, V_{GS} = 0V$                            |
|                                 |                                      | —    | —     | 250   |          | $V_{DS} = 44V, V_{GS} = 0V, T_J = 150^\circ\text{C}$   |
| $I_{GSS}$                       | Gate-to-Source Forward Leakage       | —    | —     | 100   | nA       | $V_{GS} = 20V$   |
|                                 | Gate-to-Source Reverse Leakage       | —    | —     | -100  |          | $V_{GS} = -20V$  |
| $Q_g$                           | Total Gate Charge                    | —    | —     | 34    | nC       | $I_D = 16A$  |
| $Q_{gs}$                        | Gate-to-Source Charge                | —    | —     | 6.8   |          | $V_{DS} = 44V$   |
| $Q_{gd}$                        | Gate-to-Drain ("Miller") Charge      | —    | —     | 14    |          | $V_{GS} = 10V$ , See Fig. 6 and 13 ⓄⓅ                  |
| $t_{d(on)}$                     | Turn-On Delay Time                   | —    | 7.0   | —     | ns       | $V_{DD} = 28V$   |
| $t_r$                           | Rise Time                            | —    | 49    | —     |          | $I_D = 16A$  |
| $t_{d(off)}$                    | Turn-Off Delay Time                  | —    | 31    | —     |          | $R_G = 18\Omega$                                       |
| $t_f$                           | Fall Time                            | —    | 40    | —     |          | $R_D = 1.8\Omega$ , See Fig. 10 ⓄⓅ                     |
| $L_S$                           | Internal Source Inductance           | —    | 7.5   | —     | nH       | Between lead,<br>and center of die contact             |
| $C_{iss}$                       | Input Capacitance                    | —    | 700   | —     | pF       | $V_{GS} = 0V$  |
| $C_{oss}$                       | Output Capacitance                   | —    | 240   | —     |          | $V_{DS} = 25V$   |
| $C_{rss}$                       | Reverse Transfer Capacitance         | —    | 100   | —     |          | $f = 1.0\text{MHz}$ , See Fig. 5Ⓟ                      |

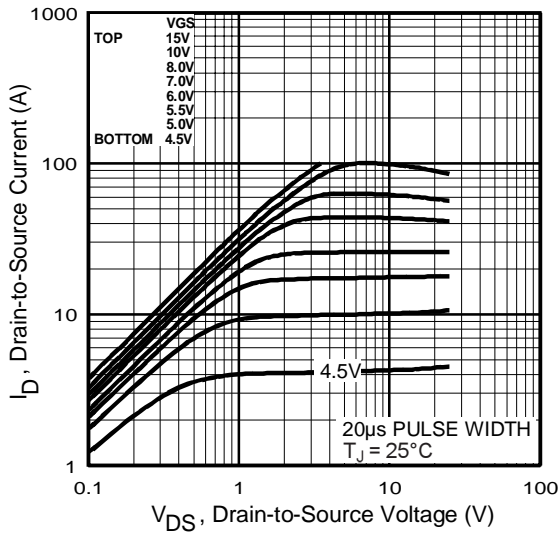
## Source-Drain Ratings and Characteristics

|          | Parameter                                 | Min.  | Typ. | Max. | Units | Conditions   |
|----------|---|---|------|------|-------|--|
| $I_S$    | Continuous Source Current<br>(Body Diode) | —   | —    | 29   | A     | MOSFET symbol<br>showing the<br>integral reverse<br>p-n junction diode.<br> |
| $I_{SM}$ | Pulsed Source Current<br>(Body Diode) Ⓛ   | —   | —    | 100  |       |  |
| $V_{SD}$ | Diode Forward Voltage                     | —   | —    | 1.6  | V     | $T_J = 25^\circ\text{C}, I_S = 16A, V_{GS} = 0V$ Ⓞ   |
| $t_{rr}$ | Reverse Recovery Time                     | —   | 57   | 86   | ns    | $T_J = 25^\circ\text{C}, I_F = 16A$  |
| $Q_{rr}$ | Reverse Recovery Charge                   | —   | 130  | 200  | nC    | $di/dt = 100A/\mu s$ ⓄⓅ  |
| $t_{on}$ | Forward Turn-On Time                      | Intrinsic turn-on time is negligible (turn-on is dominated by $L_S+L_D$ ) |      |      |       |  |

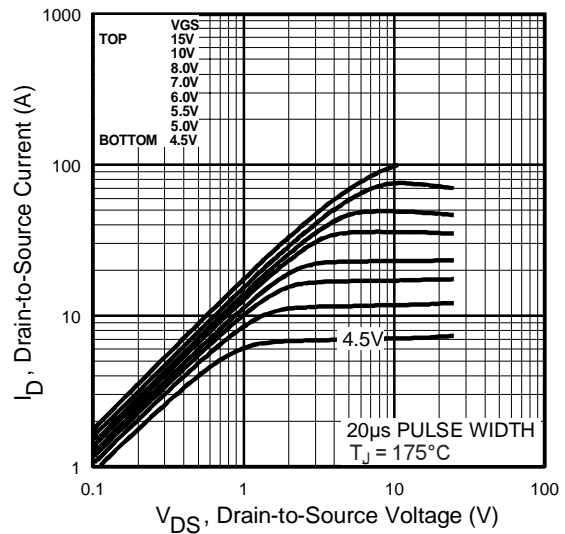
### Notes:

- Ⓛ Repetitive rating; pulse width limited by max. junction temperature. ( See fig. 11 )
- Ⓞ  $V_{DD} = 25V$ , starting  $T_J = 25^\circ\text{C}$ ,  $L = 610\mu H$   
 $R_G = 25\Omega, I_{AS} = 16A$ . (See Figure 12)
- Ⓟ  $I_{SD} \leq 16 A, di/dt \leq 420A/\mu s, V_{DD} \leq V_{(BR)DSS}, T_J \leq 175^\circ\text{C}$
- Ⓠ Pulse width  $\leq 300\mu s$ ; duty cycle  $\leq 2\%$ .
- Ⓡ Uses IRFZ34N data and test conditions

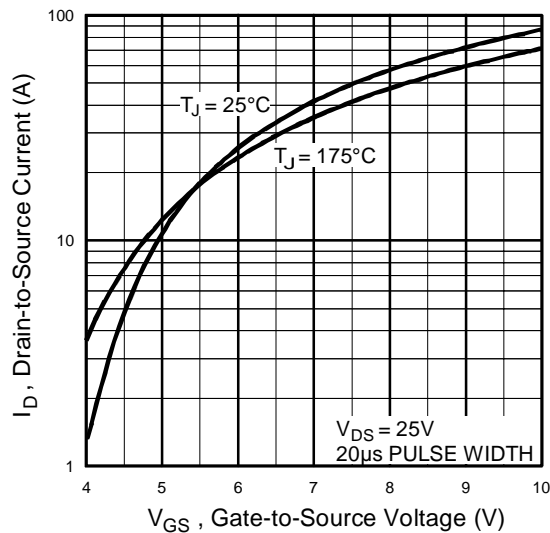
\*\* When mounted on 1" square PCB (FR-4 or G-10 Material ).  
For recommended footprint and soldering techniques refer to application note #AN-994.



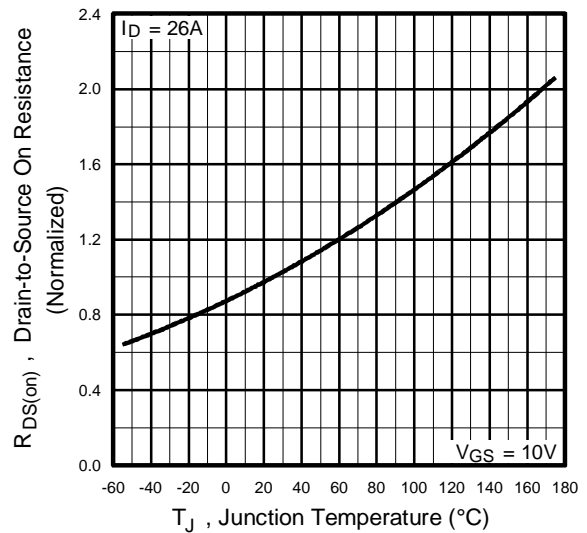
**Fig 1.** Typical Output Characteristics



**Fig 2.** Typical Output Characteristics

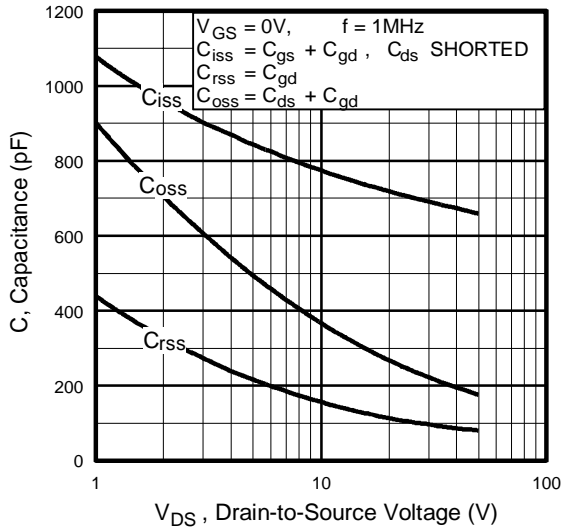


**Fig 3.** Typical Transfer Characteristics

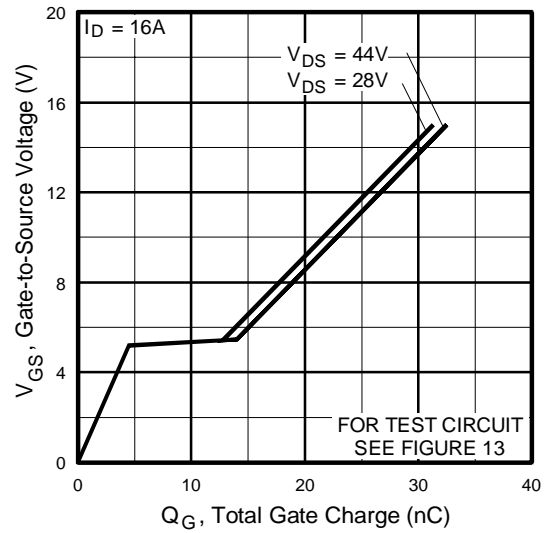


**Fig 4.** Normalized On-Resistance Vs. Temperature

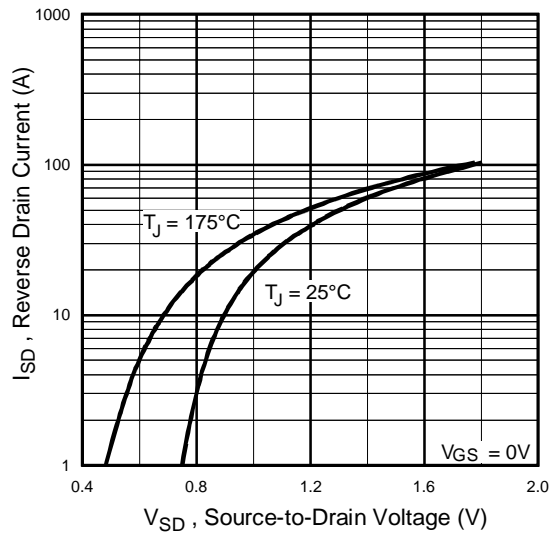
# IRFZ34NS/LPbF



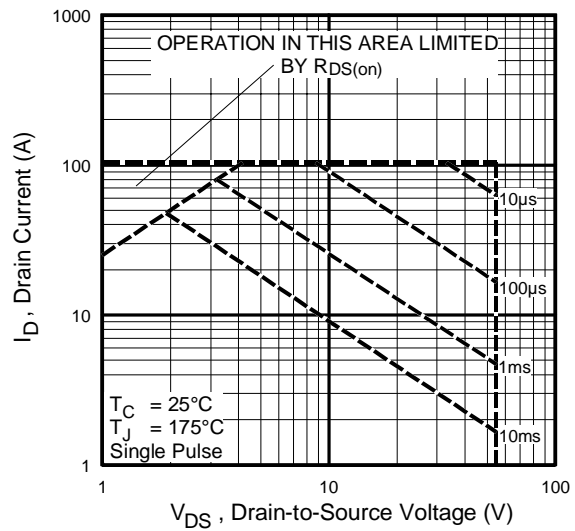
**Fig 5.** Typical Capacitance Vs. Drain-to-Source Voltage



**Fig 6.** Typical Gate Charge Vs. Gate-to-Source Voltage

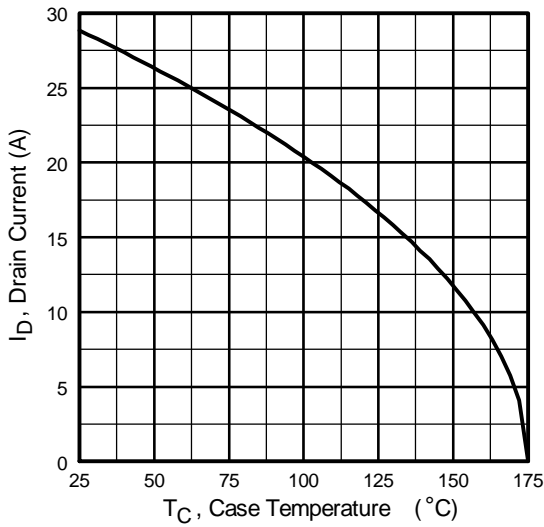


**Fig 7.** Typical Source-Drain Diode Forward Voltage

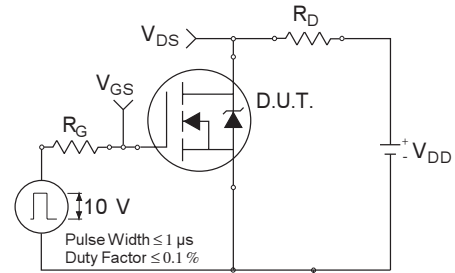


**Fig 8.** Maximum Safe Operating Area

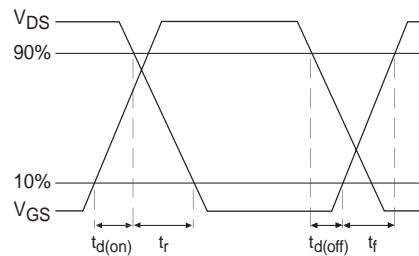
# IRFZ34NS/LPbF



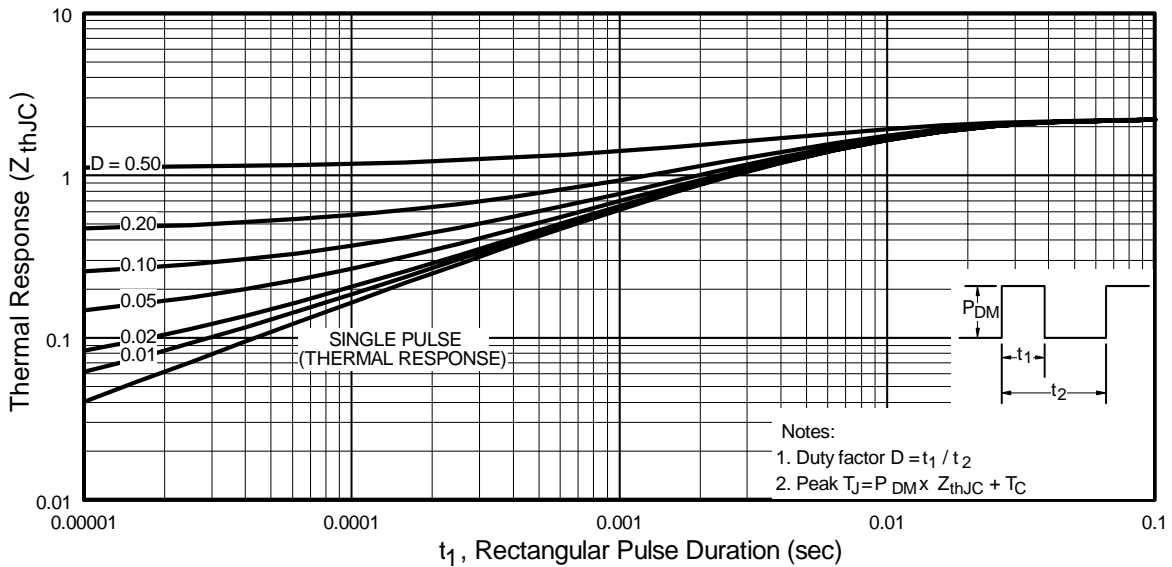
**Fig 9.** Maximum Drain Current Vs. Case Temperature



**Fig 10a.** Switching Time Test Circuit



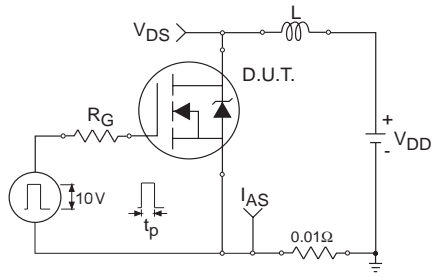
**Fig 10b.** Switching Time Waveforms



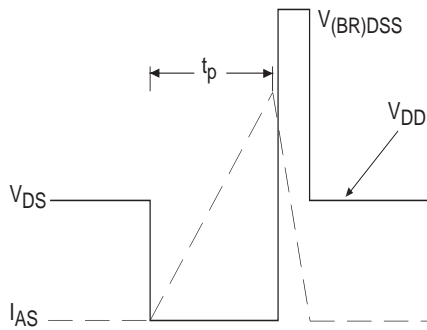
**Fig 11.** Maximum Effective Transient Thermal Impedance, Junction-to-Case

# IRFZ34NS/LPbF

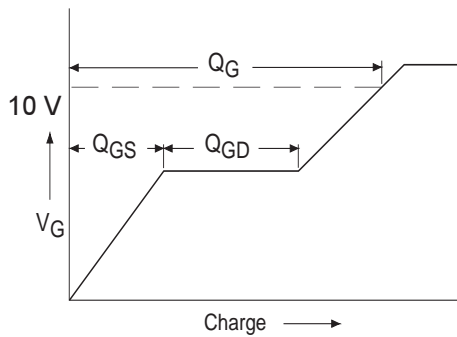
International  
**IRF** Rectifier



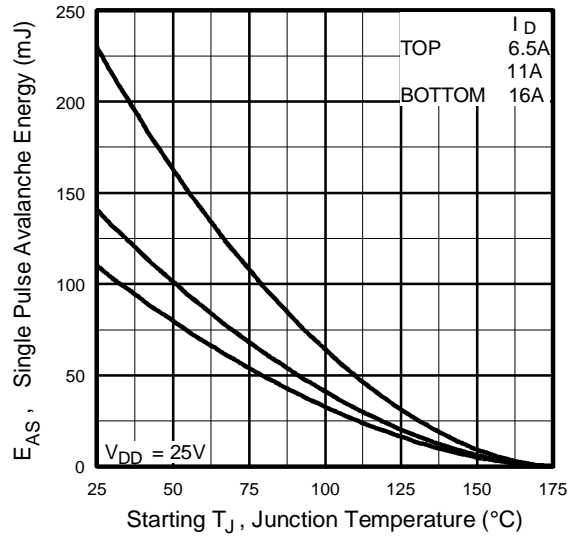
**Fig 12a.** Unclamped Inductive Test Circuit



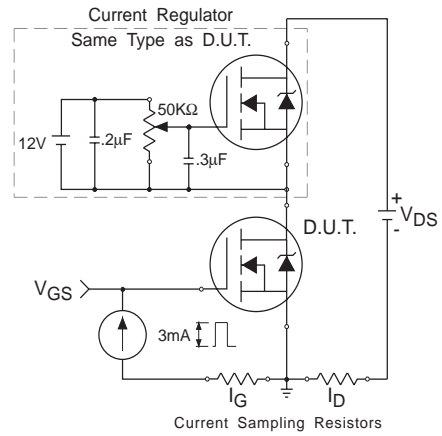
**Fig 12b.** Unclamped Inductive Waveforms



**Fig 13a.** Basic Gate Charge Waveform

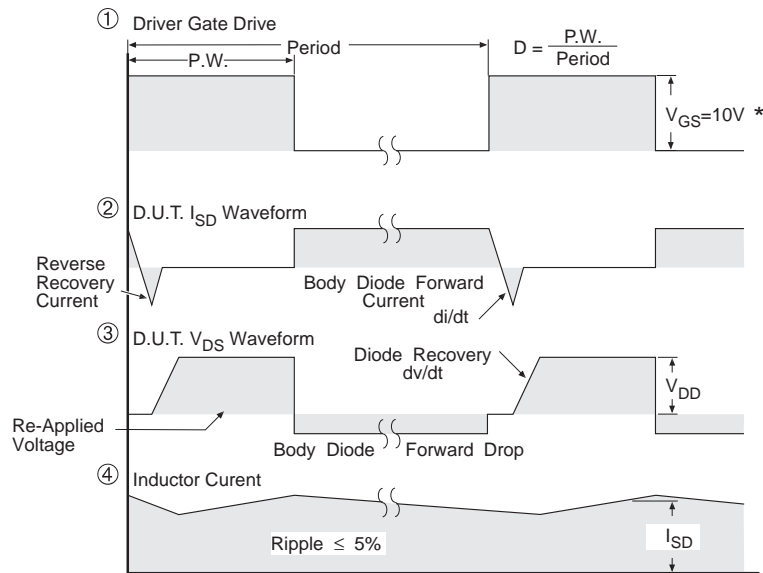
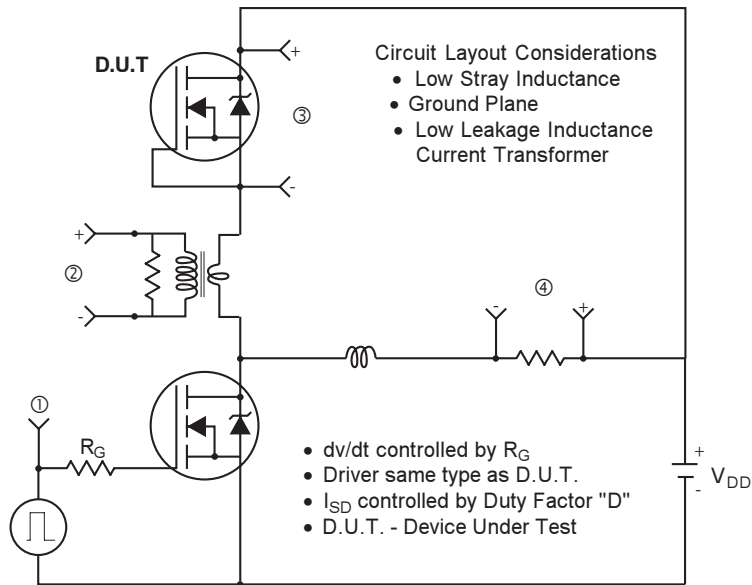


**Fig 12c.** Maximum Avalanche Energy Vs. Drain Current



**Fig 13b.** Gate Charge Test Circuit

## Peak Diode Recovery dv/dt Test Circuit



\*  $V_{GS} = 5V$  for Logic Level Devices

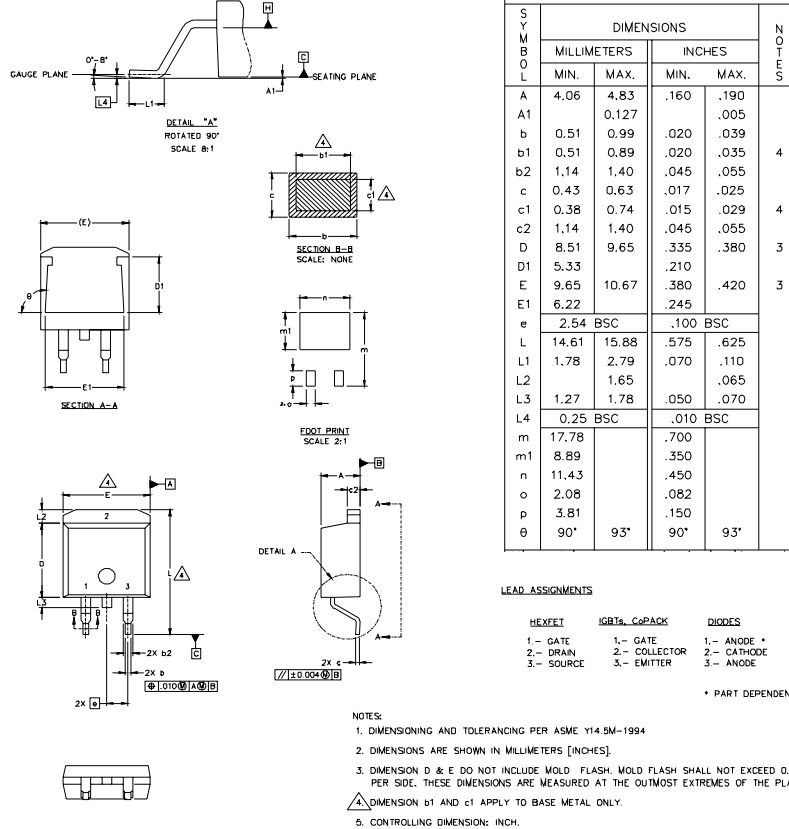
**Fig 14.** For N-Channel HEXFETS

# IRFZ34NS/LPbF

International  
**IR** Rectifier

## D<sup>2</sup>Pak Package Outline

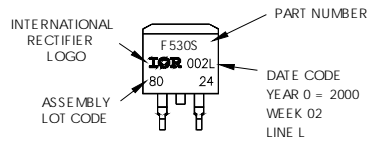
Dimensions are shown in millimeters (inches)



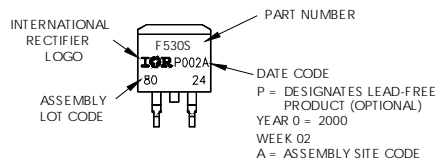
## D<sup>2</sup>Pak Part Marking Information

EXAMPLE: THIS IS AN IRF530S WITH  
LOT CODE 8024  
ASSEMBLED ON WW02, 2000  
IN THE ASSEMBLY LINE "L"

Note: "P" in assembly line  
position indicates "Lead-Free"

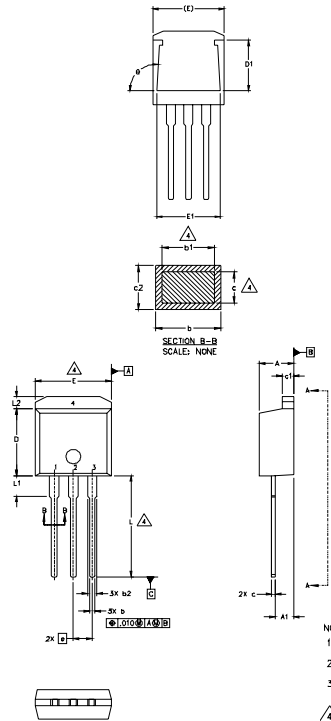


**OR**



## TO-262 Package Outline

Dimensions are shown in millimeters (inches)



| SYMBOL | DIMENSIONS  |       |          |      | NOTES |
|--------|-------------|-------|----------|------|-------|
|        | MILLIMETERS |       | INCHES   |      |       |
|        | MIN.        | MAX.  | MIN.     | MAX. |       |
| A      | 4.06        | 4.83  | .160     | .190 |       |
| A1     | 2.03        | 2.92  | .080     | .115 |       |
| b      | 0.51        | 0.99  | .020     | .039 |       |
| b1     | 0.51        | 0.89  | .020     | .035 | 4     |
| b2     | 1.14        | 1.40  | .045     | .055 |       |
| c      | 0.38        | 0.63  | .015     | .025 | 4     |
| c1     | 1.14        | 1.40  | .045     | .055 |       |
| c2     | 0.43        | .063  | .017     | .029 |       |
| D      | 8.51        | 9.65  | .335     | .380 | 3     |
| D1     | 5.33        |       | .210     |      |       |
| E      | 9.65        | 10.67 | .380     | .420 | 3     |
| E1     | 6.22        |       | .245     |      |       |
| e      | 2.54 BSC    |       | .100 BSC |      |       |
| L      | 13.46       | 14.09 | .530     | .555 |       |
| L1     | 3.56        | 3.71  | .140     | .146 |       |
| L2     |             | 1.65  |          | .065 |       |

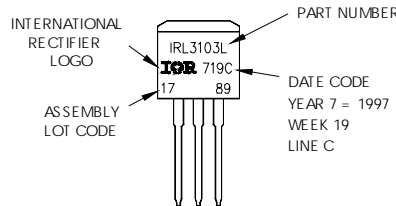
### LEAD ASSIGNMENTS

| HEXFET     | IGBT          |
|------------|---------------|
| 1.- GATE   | 1 - GATE      |
| 2.- DRAIN  | 2 - COLLECTOR |
| 3.- SOURCE | 3 - EMITTER   |
| 4.- DRAIN  |               |

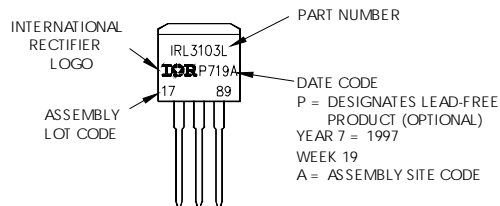
- NOTES:
1. DIMENSIONING AND TOLERANCING PER ASME Y14.5M-1994
  2. DIMENSIONS ARE SHOWN IN MILLIMETERS [INCHES].
  3. DIMENSION D & E DO NOT INCLUDE MOLD FLASH. MOLD FLASH SHALL NOT EXCEED 0.127 [0.005] PER SIDE. THESE DIMENSIONS ARE MEASURED AT THE OUTMOST EXTREMES OF THE PLASTIC BODY.
  4. DIMENSION b1 AND c1 APPLY TO BASE METAL ONLY.
  5. CONTROLLING DIMENSION: INCH.

## TO-262 Part Marking Information

EXAMPLE: THIS IS AN IRL3103L  
 LOT CODE 1789  
 ASSEMBLED ON WW 19, 1997  
 IN THE ASSEMBLY LINE "C"  
 Note: "P" in assembly line  
 position indicates "Lead-Free"



**OR**

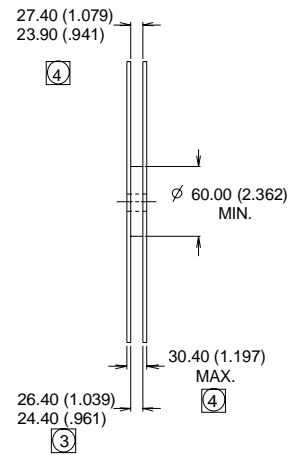
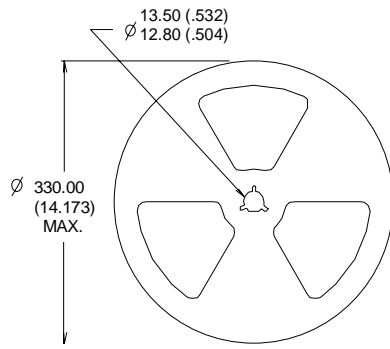
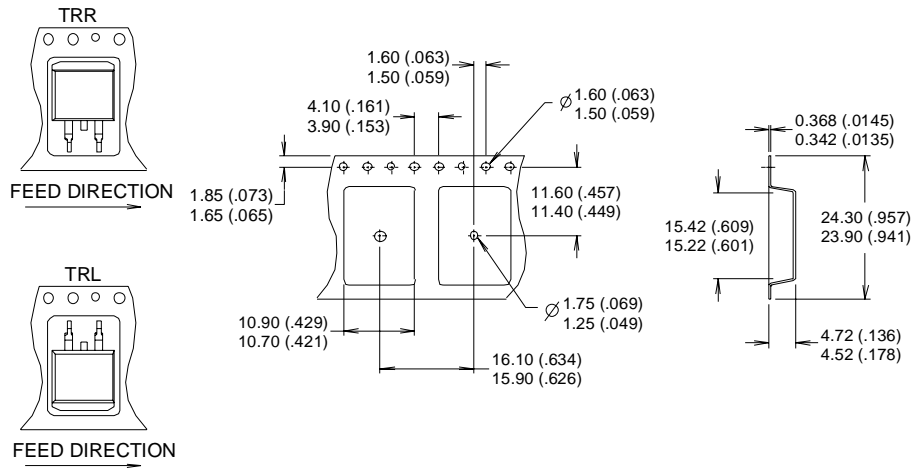


# IRFZ34NS/LPbF

International  
**IR** Rectifier

## D<sup>2</sup>Pak Tape & Reel Information

Dimensions are shown in millimeters (inches)



- NOTES:
1. COMFORMS TO EIA-418.
  2. CONTROLLING DIMENSION: MILLIMETER.
  - ③ DIMENSION MEASURED @ HUB.
  - ④ INCLUDES FLANGE DISTORTION @ OUTER EDGE.

Data and specifications subject to change without notice.

International  
**IR** Rectifier

IR WORLD HEADQUARTERS: 233 Kansas St., El Segundo, California 90245, USA Tel: (310) 252-7105  
TAC Fax: (310) 252-7903

Visit us at [www.irf.com](http://www.irf.com) for sales contact information. 07/04

[www.irf.com](http://www.irf.com)

Note: For the most current drawings please refer to the IR website at:  
<http://www.irf.com/package/>

## **IMPORTANT NOTICE**

The information given in this document shall in no event be regarded as a guarantee of conditions or characteristics ("Beschaffenheitsgarantie").

With respect to any examples, hints or any typical values stated herein and/or any information regarding the application of the product, Infineon Technologies hereby disclaims any and all warranties and liabilities of any kind, including without limitation warranties of non-infringement of intellectual property rights of any third party.

In addition, any information given in this document is subject to customer's compliance with its obligations stated in this document and any applicable legal requirements, norms and standards concerning customer's products and any use of the product of Infineon Technologies in customer's applications.

The data contained in this document is exclusively intended for technically trained staff. It is the responsibility of customer's technical departments to evaluate the suitability of the product for the intended application and the completeness of the product information given in this document with respect to such application.

For further information on the product, technology, delivery terms and conditions and prices please contact your nearest Infineon Technologies office ([www.infineon.com](http://www.infineon.com)).

## **WARNINGS**

Due to technical requirements products may contain dangerous substances. For information on the types in question please contact your nearest Infineon Technologies office.

Except as otherwise explicitly approved by Infineon Technologies in a written document signed by authorized representatives of Infineon Technologies, Infineon Technologies' products may not be used in any applications where a failure of the product or any consequences of the use thereof can reasonably be expected to result in personal injury.

## Looking for pricing, stock, or lifecycle information?

Click below to explore more details on WIN SOURCE:

 [View IRFZ34NSTRR on WIN SOURCE](#)

 [Infineon Technologies](#) Information

## Optimize Your Supply Chain with WIN SOURCE Solutions

-  Global Sourcing Solution
-  Obsolete Management
-  Cost Control Management
-  Shortage Management
-  Alternative Solution
-  Excess Inventory Management