



**THE DATASHEET OF
ISL80136IBEAJZ-T**



ISL80136

40V, Low Quiescent Current, High Accuracy, 50mA Linear Regulator

The [ISL80136](#) is a high voltage, low quiescent current linear regulator ideally suited for “always-on” and “keep alive” applications. The ISL80136 operates from an input voltage of +6V to +40V under normal operating conditions, consuming only 18μA of quiescent current at no load.

The ISL80136 offers adjustable output voltages from 2.5V to 12V. It features an EN pin that can be used to put the device into a low-quiescent current shutdown mode where it draws only 1.8μA of supply current. The device features over-temperature shutdown and current limit protection.

The ISL80136 is rated across the -40°C to +125°C temperature range and is available in an 8 lead EPSON with an exposed pad package.

Applications

- Industrial
- Networking
- Telecom

Features

- Wide V_{IN} range of 6V to 40V
- Adjustable output voltage from 2.5V to 12V
- Ensured 50mA output current
- Ultra low 18μA typical quiescent current
- Low 1.8μA of typical shutdown current
- ±1% accurate voltage reference (over temperature, load)
- Low dropout voltage of 120mV at 50mA
- Low 26μV_{RMS} noise
- 40V tolerant logic level (TTL/CMOS) enable input
- Stable operation with 10μF output capacitor
- 5kV ESD HBM rated
- Thermal shutdown and current limit protection

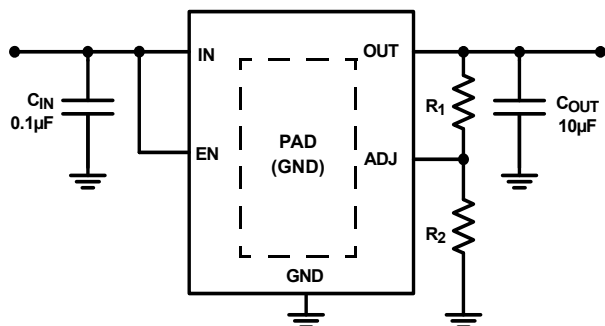

FIGURE 1. TYPICAL APPLICATION

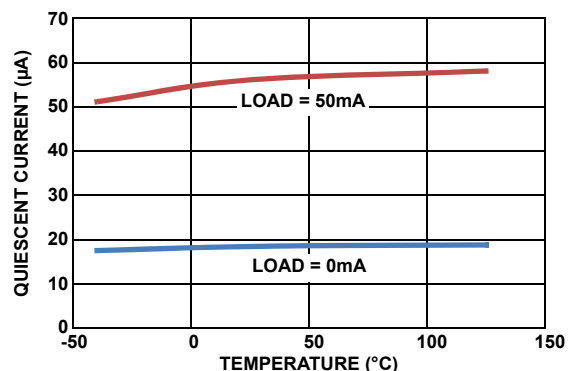
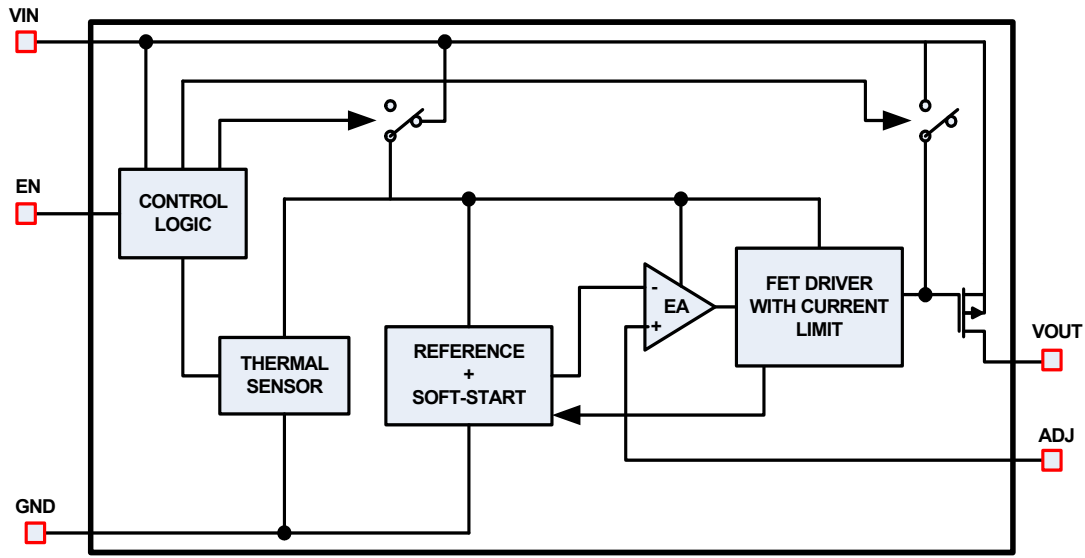

FIGURE 2. QUIESCENT CURRENT vs LOAD CURRENT (AT UNITY GAIN), $V_{IN} = 14V$

Block Diagram



Ordering Information

| PART NUMBER (Notes 2, 3) | PART MARKING | ENABLE PIN | OUTPUT VOLTAGE (V) | PACKAGE DESCRIPTION (RoHS Compliant) | PKG. DWG. # | CARRIER TYPE (Note 1) | TEMP. RANGE (°C) |
|-----------------------------|---------------------|------------|--------------------|---|-------------|--------------------------|------------------|
| ISL80136IBEAJZ | 80136 IBEAJZ | Yes | ADJ | 8 Ld EPSOIC | M8.15B | Tube | -40 to +125 |
| ISL80136IBEAJZ-T | | | | | | Reel, 2.5k | |
| ISL80136IBEAJZ-T7A | | | | | | Reel, 250 | |
| ISL80136EVAL1Z | Evaluation Platform | | | | | | |

NOTES:

- See [TB347](#) for details about reel specifications.
- These Pb-free plastic packaged products employ special Pb-free material sets, molding compounds/die attach materials, and 100% matte tin plate plus anneal (e3 termination finish, which is RoHS compliant and compatible with both SnPb and Pb-free soldering operations). Pb-free products are MSL classified at Pb-free peak reflow temperatures that meet or exceed the Pb-free requirements of IPC/JEDEC J STD-020.
- For Moisture Sensitivity Level (MSL), see the [ISL80136](#) device page. For more information about MSL, see [TB363](#).

TABLE 1. KEY DIFFERENCES IN FAMILY OF 40V LDO PARTS

| PART NUMBER | MINIMUM I _{OUT} | IC PACKAGE |
|-------------|--------------------------|--------------|
| ISL80410 | 150mA | 8 Ld EPSOIC |
| ISL80136 | 50mA | 8 Ld EPSOIC |
| ISL80138 | 150mA | 14 LD HTSSOP |

Pin Configuration

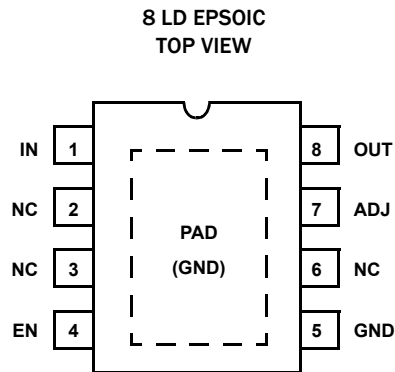

Pin Descriptions

| PIN # | PIN NAME | DESCRIPTION |
|---------|----------|---|
| 1 | IN | Input voltage pin. A minimum 0.1 μ F X5R/X7R capacitor is required for proper operation. Range: 6V to 40V |
| 2, 3, 6 | NC | Pins have internal termination and can be left unconnected. Connection to ground is optional. |
| 4 | EN | High on this pin enables the device. Range: 0V to V_{IN} |
| 5 | GND | Ground pin. |
| 7 | ADJ | This pin is connected to the external feedback resistor divider, which sets the LDO output voltage. |
| 8 | OUT | Regulated output voltage. A 10 μ F X5R/X7R output capacitor is required for stability. Range: 0V to 12V |
| - | PAD | It is recommended to solder the PAD to the ground plane. |

Absolute Maximum Ratings

| | |
|--|--------------------|
| IN Pin to GND Voltage | GND - 0.3V to +45V |
| OUT Pin to GND Voltage | GND - 0.3V to 16V |
| EN Pin to GND Voltage | GND - 0.3V to IN |
| ADJ Pin to GND Voltage | GND - 0.3V to 3V |
| Output Short-circuit Duration | Indefinite |
| ESD Rating | |
| Human Body Model (Tested per JESD22-A114E) | 5kV |
| Machine Model (Tested per JESD-A115-A) | 200V |
| Charge Device Model (Tested per JESD22-C101C) | 2.2kV |
| Latch-Up (Tested per JESD78B; Class II, Level A) | 100mA |

Thermal Information

| | | |
|-----------------------------------|---------------------------|----------------------|
| Thermal Resistance (Typical) | θ_{JA} (°C/W) | θ_{JC} (°C/W) |
| 8 Ld EPSON Package (Notes 4, 5) | 50 | 9 |
| Maximum Junction Temperature | +150°C | |
| Maximum Storage Temperature Range | -65°C to +175°C | |
| Pb-Free Reflow Profile | see TB493 | |

Recommended Operating Conditions

| | |
|---------------------------|-----------------|
| Ambient Temperature Range | -40°C to +125°C |
| IN Pin to GND Voltage | +6V to +40V |
| OUT Pin to GND Voltage | +2.5V to +12V |
| EN Pin to GND Voltage | 0V to +40V |

CAUTION: Do not operate at or near the maximum ratings listed for extended periods of time. Exposure to such conditions can adversely impact product reliability and result in failures not covered by warranty.

NOTES:

- θ_{JA} is measured in free air with the component mounted on a high-effective thermal conductivity test board with "direct attach" features. See [TB379](#).
- For θ_{JC} , the "case temp" location is the center of the exposed metal pad on the package underside.

Electrical Specifications Recommended operating conditions, unless otherwise noted. $V_{IN} = 14V$, $I_{OUT} = 1mA$, $T_A = T_J = -40^\circ C$ to $+125^\circ C$, unless otherwise noted. Typical specifications are at $T_A = +25^\circ C$. **Boldface limits apply across the operating temperature range, $-40^\circ C$ to $+125^\circ C$.**

| PARAMETER | SYMBOL | TEST CONDITIONS | MIN (Note 8) | TYP | MAX (Note 8) | UNIT |
|--------------------------------|---|---|-----------------|-------|-----------------|---------------|
| Input Voltage Range | V_{IN} | | 6 | | 40 | V |
| Guaranteed Output Current | I_{OUT} | $V_{IN} = V_{OUT} + V_{DO}$ | 50 | | | mA |
| ADJ Reference Voltage | V_{REF} | EN = High, $V_{IN} = 14V$, $I_{OUT} = 0.1mA$ to 50mA | 1.211 | 1.223 | 1.235 | V |
| Line Regulation | $(V_{OUT\ low\ line} - V_{OUT\ high\ line}) / V_{OUT\ low\ line}$ | $6V < V_{IN} < 40V$, $I_{OUT} = 1mA$ | | 0.04 | 0.115 | % |
| Load Regulation | $(V_{OUT\ no\ load} - V_{OUT\ high\ load}) / V_{OUT\ no\ load}$ | $V_{IN} = 14V$, $I_{OUT} = 100\mu A$ to 50mA | | 0.25 | 0.5 | % |
| Dropout Voltage (Note 6) | ΔV_{DO} | $I_{OUT} = 1mA$, $V_{OUT} = 2.5V$ | | 10 | 38 | mV |
| | | $I_{OUT} = 50mA$, $V_{OUT} = 2.5V$ | | 130 | 340 | mV |
| | | $I_{OUT} = 1mA$, $V_{OUT} = 5V$ | | 10 | 48 | mV |
| | | $I_{OUT} = 50mA$, $V_{OUT} = 5V$ | | 120 | 350 | mV |
| Shutdown Current | I_{SHDN} | EN = LOW | | 1.8 | 3.64 | μA |
| Quiescent Current | I_Q | EN = HIGH, $I_{OUT} = 0mA$ | | 18 | 24 | μA |
| | | EN = HIGH, $I_{OUT} = 1mA$ | | 22 | 42 | μA |
| | | EN = HIGH, $I_{OUT} = 10mA$ | | 34 | 60 | μA |
| | | EN = HIGH, $I_{OUT} = 50mA$ | | 56 | 82 | μA |
| Power Supply Rejection Ratio | PSRR | f = 100Hz; $V_{IN_RIPPLE} = 500mV_{p-p}$; Load = 50mA | | 58 | | dB |
| Output Voltage Noise | | $V_{IN} = 14V$, $V_{OUT} = 3.3V$, $C_{OUT} = 10\mu F$, $I_{OUT} = 10mA$, BW = 100Hz to 100kHz | | 26 | | μV_{RMS} |
| EN FUNCTION | | | | | | |
| EN Threshold Voltage | V_{EN_H} | $V_{OUT} = \text{Off to On}$ | | | 1.485 | V |
| | V_{EN_L} | $V_{OUT} = \text{On to Off}$ | 0.935 | | | V |
| EN Pin Current | I_{EN} | $V_{OUT} = 0V$ | | 0.026 | | μA |
| EN to Regulation Time (Note 7) | t_{EN} | | | 1.65 | 1.93 | ms |

Electrical Specifications Recommended operating conditions, unless otherwise noted. $V_{IN} = 14V$, $I_{OUT} = 1mA$, $T_A = T_J = -40^\circ C$ to $+125^\circ C$, unless otherwise noted. Typical specifications are at $T_A = +25^\circ C$. **Boldface limits apply across the operating temperature range, $-40^\circ C$ to $+125^\circ C$.** (Continued)

| PARAMETER | SYMBOL | TEST CONDITIONS | MIN (Note 8) | TYP | MAX (Note 8) | UNIT |
|-----------------------------|-------------|-----------------------------|-----------------|------|-----------------|------------|
| PROTECTION FEATURES | | | | | | |
| Output Current Limit | I_{LIMIT} | $V_{OUT} = 0V$ | 60 | 118 | | mA |
| Thermal Shutdown | T_{SHDN} | Junction Temperature Rising | | +165 | | $^\circ C$ |
| Thermal Shutdown Hysteresis | T_{HYST} | | | +20 | | $^\circ C$ |

NOTES:

6. Dropout voltage is defined as $(V_{IN} - V_{OUT})$ when V_{OUT} is 2% below the value of V_{OUT} .
7. Enable to Regulation Time is the time the output takes to reach 95% of its final value with $V_{IN} = 14V$ and EN is taken from V_{IL} to V_{IH} in 5ns. The output voltage is set at 5V.
8. Parameters with MIN and/or MAX limits are 100% tested at $+25^\circ C$, unless otherwise specified. Temperature limits established by characterization and are not production tested.

Typical Performance Curves $V_{IN} = 14V, I_{OUT} = 1mA, V_{OUT} = 5V, T_J = +25^\circ C$ unless otherwise specified.

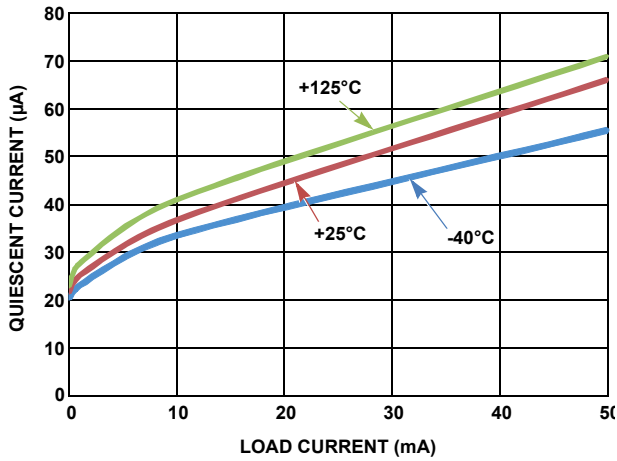

FIGURE 3. QUIESCENT CURRENT vs LOAD CURRENT

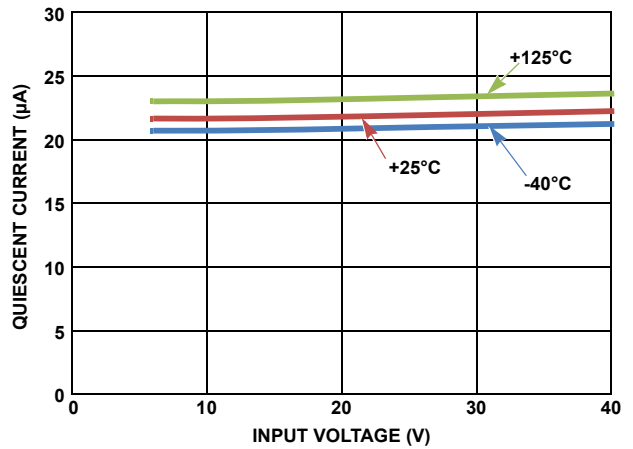

FIGURE 4. QUIESCENT CURRENT vs INPUT VOLTAGE (NO LOAD)

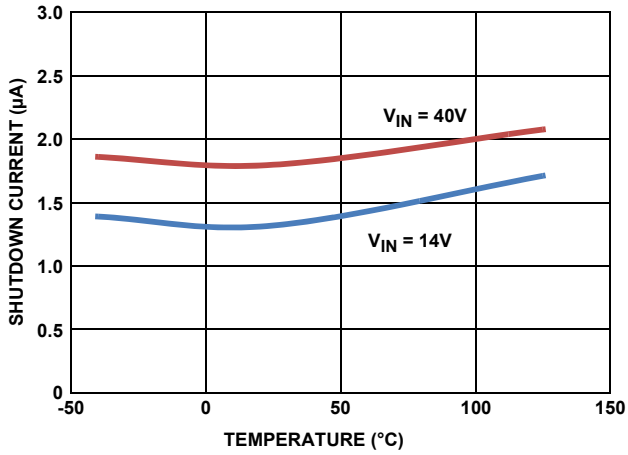

FIGURE 5. SHUTDOWN CURRENT vs TEMPERATURE (EN = 0)

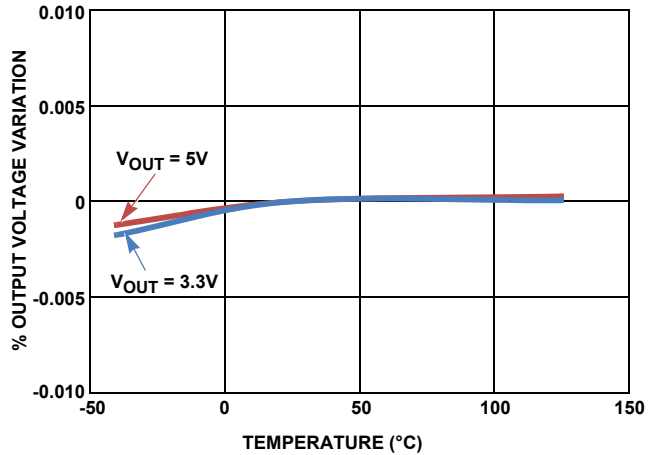

FIGURE 6. OUTPUT VOLTAGE vs TEMPERATURE (LOAD = 50mA)

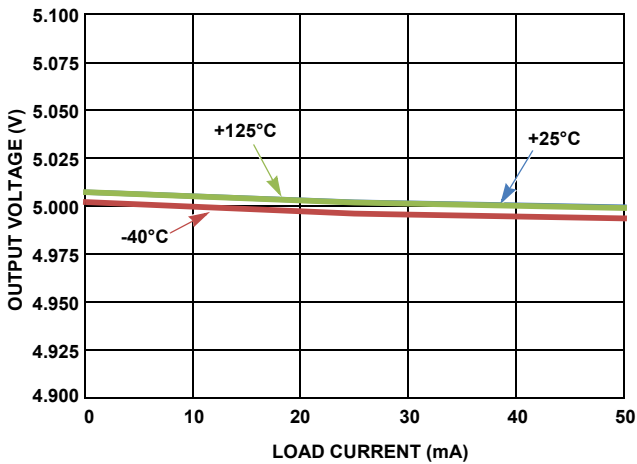

FIGURE 7. OUTPUT VOLTAGE vs LOAD CURRENT

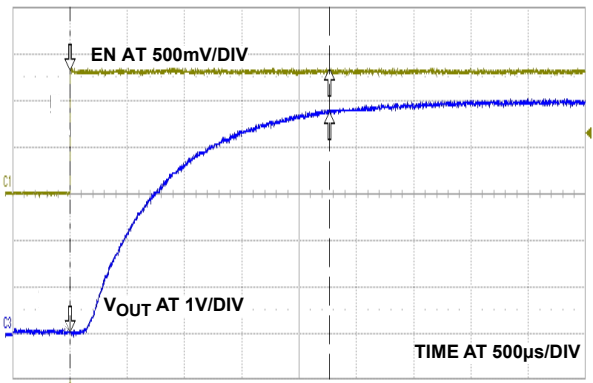

FIGURE 8. START-UP WAVEFORM

Typical Performance Curves $V_{IN} = 14V, I_{OUT} = 1mA, V_{OUT} = 5V, T_J = +25^\circ C$ unless otherwise specified. (Continued)

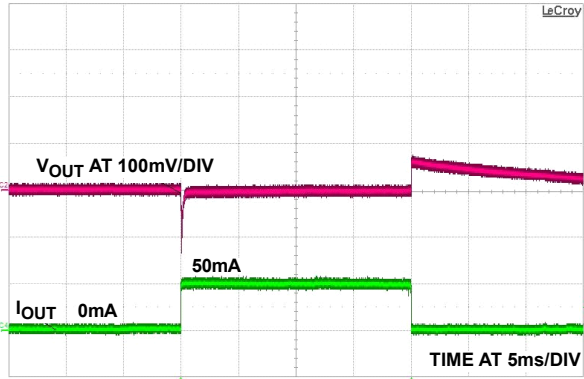

FIGURE 9. LOAD TRANSIENT RESPONSE

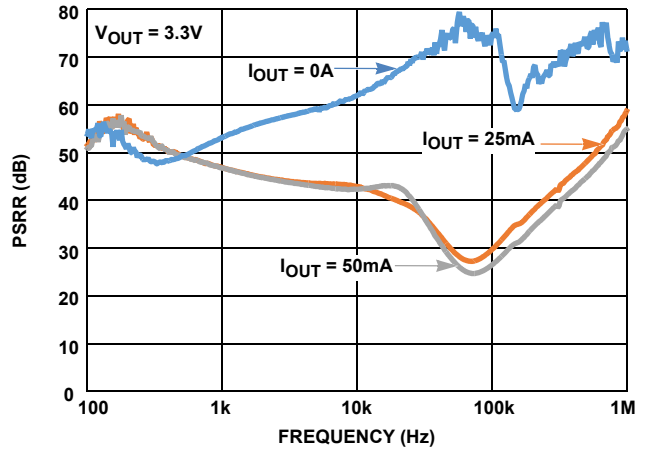

FIGURE 10. PSRR vs FREQUENCY FOR VARIOUS LOAD CURRENT, $V_{OUT} = 3.3V$

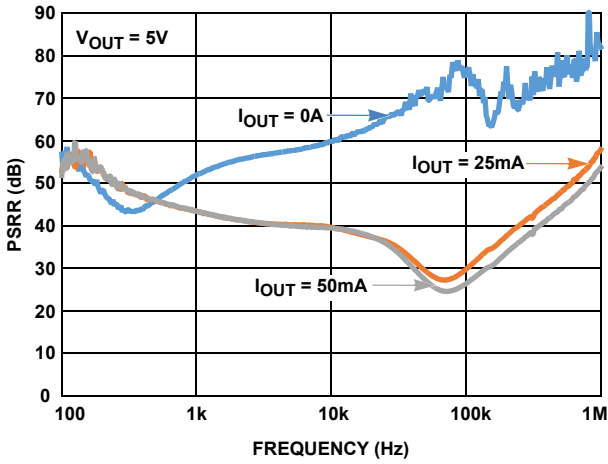

FIGURE 11. PSRR vs FREQUENCY FOR VARIOUS LOAD CURRENT, $V_{OUT} = 5V$

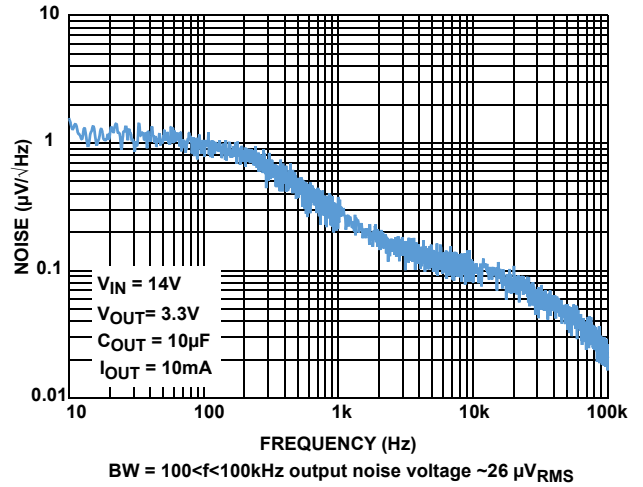

FIGURE 12. OUTPUT NOISE SPECTRAL DENSITY, $I_{OUT} = 10mA$

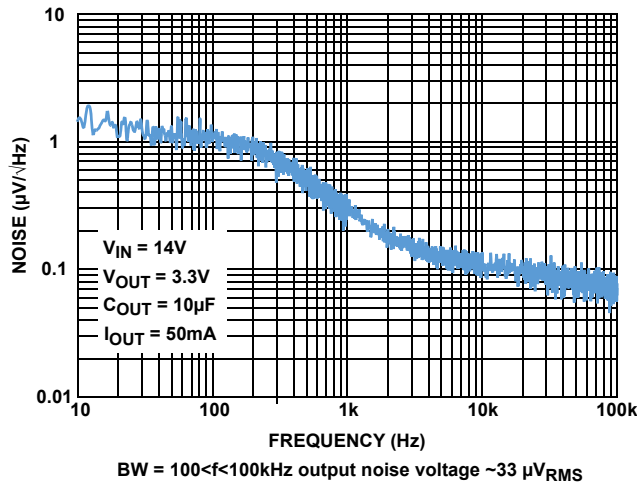

FIGURE 13. OUTPUT NOISE SPECTRAL DENSITY, $I_{OUT} = 50mA$

Functional Description

Functional Overview

The ISL80136 is a high performance, high voltage, low-dropout regulator (LDO) with 50mA sourcing capability. The part is rated to operate across the -40°C to $+125^{\circ}\text{C}$ temperature range. Featuring ultra-low quiescent current, it makes an ideal choice for “always-on” applications. It works well under a “load dump condition” where the input voltage could rise up to 40V. The device also features current limit and thermal shutdown protection.

Enable Control

When the ISL80136's Enable pin is pulled low, the IC goes into shutdown mode. In this condition, the device draws less than $2\mu\text{A}$ of current. Driving the pin high turns the device on. Tie the EN pin directly to IN for “always on” operation.

Current Limit Protection

The ISL80136 has internal current limit functionality to protect the regulator during fault conditions. During current limit, the output sources a fixed amount of current largely independent of the output voltage. If the short or overload is removed from V_{OUT} , the output returns to normal voltage regulation mode.

Thermal Fault Protection

If the die temperature exceeds typically $+165^{\circ}\text{C}$, the output of the LDO shuts down until the die temperature cools down to typically $+145^{\circ}\text{C}$. The level of power dissipated, combined with the ambient temperature and the thermal impedance of the package, determine if the junction temperature exceeds the thermal shutdown temperature. Also see the section on “[Power Dissipation](#)”.

Application Information

Input and Output Capacitors

Renesas recommends placing a ceramic capacitor (X5R or X7R) at the ISL80136's output to maintain stability. Route the ground connection of the output capacitor directly to the GND pin of the device and place it close to the IC. A minimum $0.1\mu\text{F}$ (X5R or X7R) capacitor is recommended at the input.

Output Voltage Setting

The output voltage is programmed using an external resistor divider, as shown in [Figure 14](#).

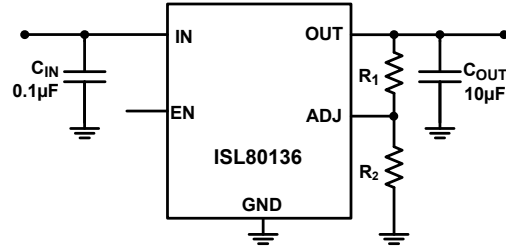

FIGURE 14. SETTING OUTPUT VOLTAGE

The output voltage is calculated using [Equation 1](#):

$$V_{\text{OUT}} = 1.223\text{V} \times \left(\frac{R_1}{R_2} + 1 \right) \quad (\text{EQ. 1})$$

Power Dissipation

The junction temperature must not exceed the range specified in “[Recommended Operating Conditions](#)” on [page 4](#). The power dissipation can be calculated using [Equation 2](#):

$$P_D = (V_{\text{IN}} - V_{\text{OUT}}) \times I_{\text{OUT}} + V_{\text{IN}} \times I_{\text{GND}} \quad (\text{EQ. 2})$$

The maximum allowable junction temperature, $T_{\text{J(MAX)}}$ and the maximum expected ambient temperature, $T_{\text{A(MAX)}}$ determine the maximum allowable junction temperature rise (ΔT_{J}), as shown in [Equation 3](#):

$$\Delta T_{\text{J}} = T_{\text{J(MAX)}} - T_{\text{A(MAX)}} \quad (\text{EQ. 3})$$

To calculate the maximum ambient operating temperature, use the junction-to-ambient thermal resistance (θ_{JA}), as shown in [Equation 4](#):

$$T_{\text{J(MAX)}} = P_{\text{D(MAX)}} \times \theta_{\text{JA}} + T_{\text{A}} \quad (\text{EQ. 4})$$

Board Layout Recommendations

A good PCB layout is important to achieve expected performance. When placing the components and routing the trace, minimize the ground impedance and keep the parasitic inductance low. The input and output capacitors should have a good ground connection and be placed as close to the IC as possible. The ADJ feedback trace should be away from other noisy traces. Connect the exposed pad to the ground plane using as many vias as possible within the pad for the best thermal relief.

Revision History

The revision history provided is for informational purposes only and is believed to be accurate, but not warranted. Please go to web to make sure you have the latest Rev.

| DATE | REVISION | CHANGE |
|--------------|----------|---|
| Oct 2, 2023 | 4.01 | Updated M8.15B POD to the latest revision (corrected typo). |
| Aug 8, 2019 | 4.0 | Updated POD to the latest revision. Changes are as follows: -Updated L Millimeter minimum in detail A from 0.41 to 0.406. -Updated the following in the Side View: -Changed total package height Millimeter MIN and MAX values from: 1.43 MIN and 1.68 MAX to: 1.422 MIN and 1.700 MAX and Inches max from 0.066 to 0.067. -Changed A1 Inches MIN from: 0.001 to 0.0, and A1 Millimeters MIN from 0.03 to 0.0 |
| Feb 20, 2019 | 3.0 | Updated title Updated Table 1 and moved to page 2. Updated the 6th bullet and added the 8th bullet in the features list. Updated Related Literature section. Updated ordering information table with tape and reel information to table and updated notes. Added Output Voltage Noise specification. Removed About Intersil section. Updated POD to the latest revision. Changes to POD are as follows: -Replace the graphics with a standard format (removing the dimension table). Updated disclaimer. |
| Aug 11, 2015 | 2.0 | Removed DFN package option throughout the datasheet. On page 1, updated Key Differences Table, Replaced "ADJ OR FIXED VOUT" Column with "IC PACKAGE" column. On page 2, updated Block Diagram, removed two resistors and switched polarity of EA. Electrical spec table on page 4: -Removed "C _{IN} = 0.1μF, C _{OUT} = 10μF" from the Electrical Specification heading. -Updated the ADJ Reference Voltage Test Condition IOUT value from "IOUT = 0.1mA" to "IOUT = 0.1mA to 50mA" -Updated the Line Regulation *Symbol, from " $\Delta V_{OUT}/\Delta V_{IN}$ " to " $(V_{OUT\ low\ line} - V_{OUT\ high\ line})/V_{OUT\ low\ line}$ ". *Test Conditions, from " $3V \leq V_{IN} \leq 40V, I_{OUT} = 1mA$ " to " $6V < V_{IN} < 40V, I_{OUT} = 1mA$ " -Updated the Load Regulation *Symbol, from " $\Delta V_{OUT}/\Delta I_{OUT}$ " to " $(V_{OUT\ no\ load} - V_{OUT\ high\ load})/V_{OUT\ no\ load}$ " *Test Conditions from " $V_{IN} = V_{OUT} + V_{DO}$ " to " $V_{IN} = 14V$ " -Updated Dropout Voltage Test Condition VOUT value (First two rows only) from "VOUT = 3.3V" to "VOUT = 2.5V". Updated Note 6 from "Dropout voltage is defined as $(V_{IN} - V_{OUT})$ when V_{OUT} is 2% below the value of V_{OUT} when $V_{IN} = V_{OUT} + 3V$." to "Dropout voltage is defined as $(V_{IN} - V_{OUT})$ when V_{OUT} is 2% below the value of V_{OUT} ." Removed Figure 9, "POWER SUPPLY REJECTION RATIO (LOAD = 50mA)" Added figures 10 through 13 on page 7. |
| Jan 31, 2012 | 1.0 | Added DFN package option throughout the datasheet. |
| Dec 15, 2011 | 0.0 | Initial Release. |

Package Outline Drawing

For the most recent package outline drawing, see [M8.15B](#).

M8.15B
 8 Lead Narrow Body Small Outline Exposed Pad Plastic Package
 Rev 8, 9/2023

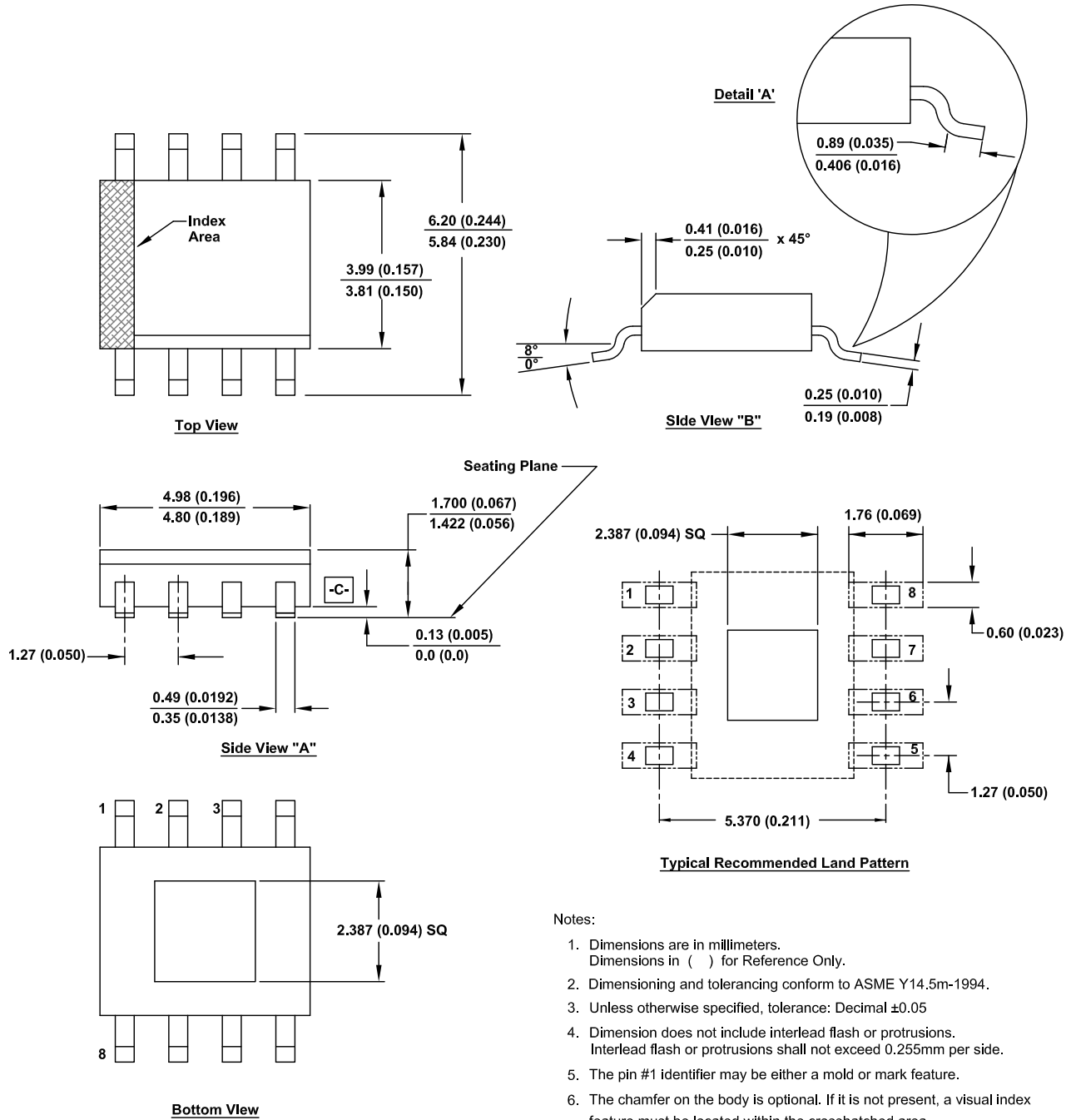

Notes:

1. Dimensions are in millimeters.
Dimensions in () for Reference Only.
2. Dimensioning and tolerancing conform to ASME Y14.5m-1994.
3. Unless otherwise specified, tolerance: Decimal ±0.05
4. Dimension does not include interlead flash or protrusions.
Interlead flash or protrusions shall not exceed 0.255mm per side.
5. The pin #1 identifier may be either a mold or mark feature.
6. The chamfer on the body is optional. If it is not present, a visual index feature must be located within the crosshatched area.

IMPORTANT NOTICE AND DISCLAIMER

RENESAS ELECTRONICS CORPORATION AND ITS SUBSIDIARIES (“RENESAS”) PROVIDES TECHNICAL SPECIFICATIONS AND RELIABILITY DATA (INCLUDING DATASHEETS), DESIGN RESOURCES (INCLUDING REFERENCE DESIGNS), APPLICATION OR OTHER DESIGN ADVICE, WEB TOOLS, SAFETY INFORMATION, AND OTHER RESOURCES “AS IS” AND WITH ALL FAULTS, AND DISCLAIMS ALL WARRANTIES, EXPRESS OR IMPLIED, INCLUDING, WITHOUT LIMITATION, ANY IMPLIED WARRANTIES OF MERCHANTABILITY, FITNESS FOR A PARTICULAR PURPOSE, OR NON-INFRINGEMENT OF THIRD PARTY INTELLECTUAL PROPERTY RIGHTS.

These resources are intended for developers skilled in the art designing with Renesas products. You are solely responsible for (1) selecting the appropriate products for your application, (2) designing, validating, and testing your application, and (3) ensuring your application meets applicable standards, and any other safety, security, or other requirements. These resources are subject to change without notice. Renesas grants you permission to use these resources only for development of an application that uses Renesas products. Other reproduction or use of these resources is strictly prohibited. No license is granted to any other Renesas intellectual property or to any third party intellectual property. Renesas disclaims responsibility for, and you will fully indemnify Renesas and its representatives against, any claims, damages, costs, losses, or liabilities arising out of your use of these resources. Renesas' products are provided only subject to Renesas' Terms and Conditions of Sale or other applicable terms agreed to in writing. No use of any Renesas resources expands or otherwise alters any applicable warranties or warranty disclaimers for these products.

(Disclaimer Rev.1.0 Mar 2020)

Corporate Headquarters

TOYOSU FORESIA, 3-2-24 Toyosu,
Koto-ku, Tokyo 135-0061, Japan
www.renesas.com

Contact Information

For further information on a product, technology, the most up-to-date version of a document, or your nearest sales office, please visit:
www.renesas.com/contact/

Trademarks

Renesas and the Renesas logo are trademarks of Renesas Electronics Corporation. All trademarks and registered trademarks are the property of their respective owners.

Looking for pricing, stock, or lifecycle information?

Click below to explore more details on WIN SOURCE:

-  [View ISL80136IBEAJZ-T on WIN SOURCE](#)
-  [Renesas Electronics America](#) Information

Optimize Your Supply Chain with WIN SOURCE Solutions

-  Global Sourcing Solution
-  Obsolete Management
-  Cost Control Management
-  Shortage Management
-  Alternative Solution
-  Excess Inventory Management