



**THE DATASHEET OF
LT3028EDHC#TRPBF**



Dual 100mA/500mA Low Dropout, Low Noise, Micropower Regulators with Independent Inputs

FEATURES

- **Low Noise:** $20\mu\text{V}_{\text{RMS}}$ (10Hz to 100kHz)
- **Low Quiescent Current:** $30\mu\text{A}/\text{Output}$
- **Independent Inputs**
- **Wide Input Voltage Range:** 1.8V to 20V
- **Output Current:** 100mA/500mA
- **Very Low Shutdown Current:** $<0.1\mu\text{A}$
- **Low Dropout Voltage:** 300mV/320mV at 100mA/500mA
- Adjustable Outputs from 1.22V to 20V
- Stable with as Low as $1\mu\text{F}/3.3\mu\text{F}$ Output Capacitor
- Stable with Aluminum, Tantalum or Ceramic Capacitors
- Reverse-Battery Protected
- No Protection Diodes Needed
- Overcurrent and Overtemperature Protected
- Tracking/Sequencing Capability
- Thermally Enhanced 16-Lead TSSOP and 16-Lead (5mm × 3mm) DFN Packages

APPLICATIONS

- Cellular Phones
- Pagers
- Battery-Powered Systems
- Frequency Synthesizers
- Wireless Modems
- Tracking/Sequencing Power Supplies

DESCRIPTION

The LT[®]3028 is a dual, micropower, low noise, low dropout regulator with independent inputs. With an external $0.01\mu\text{F}$ bypass capacitor, output noise is a low $20\mu\text{V}_{\text{RMS}}$ over a 10Hz to 100kHz bandwidth. Designed for use in battery-powered systems, the low $30\mu\text{A}$ quiescent current per output makes it an ideal choice. In shutdown, quiescent current drops to less than $0.1\mu\text{A}$. Shutdown control is independent for each output, allowing for flexibility in power management. The device is capable of operating over an input voltage range of 1.8V to 20V. Output 1 can supply 500mA of output current with a dropout voltage of 320mV. The device can supply 100mA of output current from Output 2 with a dropout voltage of 300mV. Quiescent current is well controlled in dropout.

The LT3028 regulator is stable with output capacitors as low as $1\mu\text{F}$ for the 100mA output and $3.3\mu\text{F}$ for the 500mA output. Small ceramic capacitors can be used without the series resistance required by other regulators.

Internal protection circuitry includes reverse-battery protection, current limiting and thermal limiting protection. The device is available as an adjustable device with a 1.22V reference voltage. The LT3028 regulator is available in the thermally enhanced 16-lead TSSOP and 16-lead, low profile (5mm × 3mm × 0.75mm) DFN packages.

 LTC and LT are registered trademarks of Linear Technology Corporation. Protected by U.S. Patents including 6118263, 6144250.

TYPICAL APPLICATION

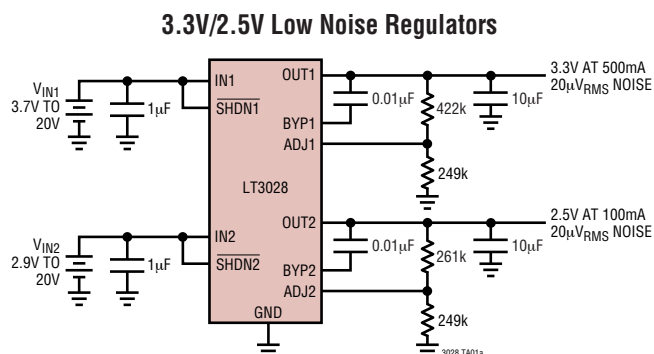

10Hz to 100kHz Output Noise

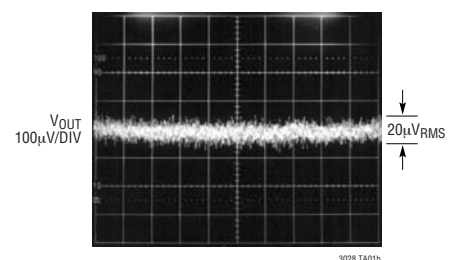

ABSOLUTE MAXIMUM RATINGS (Note 1)

| | | | |
|--|------------|--|----------------|
| IN1, IN2 Pin Voltage | ±20V | Operating Junction Temperature Range (Note 2) | -40°C to 125°C |
| OUT1, OUT2 Pin Voltage | ±20V | Storage Temperature Range | |
| Input-to-Output Differential Voltage | ±20V | FE Package | -65°C to 150°C |
| ADJ1, ADJ2 Pin Voltage | ±7V | DHC Package | -65°C to 125°C |
| BYP1, BYP2 Pin Voltage | ±0.6V | Lead Temperature (Soldering, 10 sec) | 300°C |
| SHDN1, SHDN2 Pin Voltage | ±20V | | |
| Output Short-Circuit Duration | Indefinite | | |

PACKAGE/ORDER INFORMATION

| | | | |
|---|------------------------|---|--------------------------|
| <p>FE PACKAGE 16-LEAD PLASTIC TSSOP</p> <p>$T_{JMAX} = 150^{\circ}\text{C}$, $\theta_{JA} = 38^{\circ}\text{C/W}$, $\theta_{JC} = 8^{\circ}\text{C/W}$ EXPOSED PAD (PIN 17) IS GND MUST BE SOLDERED TO PCB</p> | ORDER PART NUMBER | <p>DHC PACKAGE 16-LEAD (5mm x 3mm) PLASTIC DFN</p> <p>$T_{JMAX} = 125^{\circ}\text{C}$, $\theta_{JA} = 40^{\circ}\text{C/W}$, $\theta_{JC} = 10^{\circ}\text{C/W}$ EXPOSED PAD (PIN 17) IS GND MUST BE SOLDERED TO PCB</p> | ORDER PART NUMBER |
| | LT3028EFE LT3028IFE | | LT3028EDHC LT3028IDHC |
| | FE PART MARKING | | DHC PART MARKING |
| | 3028EFE 3028IFE | | 3028 3028I |

Consult factory for parts specified with wider operating temperature ranges.

ELECTRICAL CHARACTERISTICS

The ● denotes specifications which apply over the full operating temperature range, otherwise specifications are $T_A = 25^{\circ}\text{C}$. (Note 2)

| PARAMETER | CONDITIONS | MIN | TYP | MAX | UNITS | |
|--|---|-----|-------|-------|-------|---|
| Minimum Input Voltage (Notes 3, 10) | Output 2, $I_{LOAD} = 100\text{mA}$ | ● | 1.8 | 2.3 | V | |
| | Output 1, $I_{LOAD} = 500\text{mA}$ | ● | 1.8 | 2.3 | V | |
| ADJ1, ADJ2 Pin Voltage (Notes 3, 4) | $V_{IN} = 2\text{V}$, $I_{LOAD} = 1\text{mA}$ | | 1.205 | 1.220 | 1.235 | V |
| | Output 2, $2.3\text{V} < V_{IN2} < 20\text{V}$, $1\text{mA} < I_{LOAD} < 100\text{mA}$ | ● | 1.190 | 1.220 | 1.250 | V |
| | Output 1, $2.3\text{V} < V_{IN1} < 20\text{V}$, $1\text{mA} < I_{LOAD} < 500\text{mA}$ | ● | 1.190 | 1.220 | 1.250 | V |
| Line Regulation (Note 3) | $\Delta V_{IN} = 2\text{V}$ to 20V , $I_{LOAD} = 1\text{mA}$ | ● | 1 | 10 | mV | |
| Load Regulation (Note 3) | Output 2, $V_{IN2} = 2.3\text{V}$, $\Delta I_{LOAD} = 1\text{mA}$ to 100mA | | 1 | 12 | mV | |
| | $V_{IN2} = 2.3\text{V}$, $\Delta I_{LOAD} = 1\text{mA}$ to 100mA | ● | | 25 | mV | |
| | Output 1, $V_{IN1} = 2.3\text{V}$, $\Delta I_{LOAD} = 1\text{mA}$ to 500mA | | 1 | 12 | mV | |
| | $V_{IN1} = 2.3\text{V}$, $\Delta I_{LOAD} = 1\text{mA}$ to 500mA | ● | | 25 | mV | |

ELECTRICAL CHARACTERISTICS

The ● denotes specifications which apply over the full operating temperature range, otherwise specifications are $T_A = 25^\circ\text{C}$. (Note 2)

| PARAMETER | CONDITIONS | | MIN | TYP | MAX | UNITS |
|--|--|---|------|------|------|----------------------------|
| Dropout Voltage (Output 2) $V_{IN2} = V_{OUT2(NOMINAL)}$ (Notes 5, 6, 10) | $I_{LOAD} = 1\text{mA}$ | ● | | 0.10 | 0.15 | V |
| | $I_{LOAD} = 1\text{mA}$ | ● | | | 0.19 | V |
| | $I_{LOAD} = 10\text{mA}$ | ● | | 0.17 | 0.22 | V |
| | $I_{LOAD} = 10\text{mA}$ | ● | | | 0.29 | V |
| Dropout Voltage (Output 1) $V_{IN1} = V_{OUT1(NOMINAL)}$ (Notes 5, 6, 10) | $I_{LOAD} = 50\text{mA}$ | ● | | 0.24 | 0.31 | V |
| | $I_{LOAD} = 50\text{mA}$ | ● | | | 0.40 | V |
| | $I_{LOAD} = 100\text{mA}$ | ● | | 0.30 | 0.35 | V |
| | $I_{LOAD} = 100\text{mA}$ | ● | | | 0.45 | V |
| Dropout Voltage (Output 1) $V_{IN1} = V_{OUT1(NOMINAL)}$ (Notes 5, 6, 10) | $I_{LOAD} = 10\text{mA}$ | ● | | 0.12 | 0.19 | V |
| | $I_{LOAD} = 10\text{mA}$ | ● | | | 0.25 | V |
| | $I_{LOAD} = 50\text{mA}$ | ● | | 0.17 | 0.22 | V |
| | $I_{LOAD} = 50\text{mA}$ | ● | | | 0.32 | V |
| GND Pin Current (Output 2) $V_{IN2} = V_{OUT2(NOMINAL)}$ (Notes 5, 7) | $I_{LOAD} = 0\text{mA}$ | ● | | 25 | 50 | μA |
| | $I_{LOAD} = 1\text{mA}$ | ● | | 60 | 95 | μA |
| | $I_{LOAD} = 10\text{mA}$ | ● | | 230 | 400 | μA |
| | $I_{LOAD} = 50\text{mA}$ | ● | | 1 | 2 | mA |
| GND Pin Current (Output 1) $V_{IN1} = V_{OUT1(NOMINAL)}$ (Notes 5, 7) | $I_{LOAD} = 100\text{mA}$ | ● | | 0.21 | 0.28 | V |
| | $I_{LOAD} = 100\text{mA}$ | ● | | | 0.34 | V |
| | $I_{LOAD} = 500\text{mA}$ | ● | | 0.32 | 0.37 | V |
| | $I_{LOAD} = 500\text{mA}$ | ● | | | 0.47 | V |
| GND Pin Current (Output 1) $V_{IN1} = V_{OUT1(NOMINAL)}$ (Notes 5, 7) | $I_{LOAD} = 0\text{mA}$ | ● | | 30 | 75 | μA |
| | $I_{LOAD} = 1\text{mA}$ | ● | | 65 | 120 | μA |
| | $I_{LOAD} = 50\text{mA}$ | ● | | 1 | 1.6 | mA |
| | $I_{LOAD} = 100\text{mA}$ | ● | | 2 | 3 | mA |
| | $I_{LOAD} = 250\text{mA}$ | ● | | 5 | 8 | mA |
| Output Voltage Noise | $I_{LOAD} = 500\text{mA}$ | ● | | 10 | 16 | mA |
| | $I_{LOAD} = 500\text{mA}$ | ● | | | | |
| Output Voltage Noise | $C_{OUT} = 10\mu\text{F}$, $C_{BYP} = 0.01\mu\text{F}$, $I_{LOAD} = \text{Full Current}$, $BW = 10\text{Hz to } 100\text{kHz}$ | | | 20 | | μVRMS |
| ADJ1/ADJ2 Pin Bias Current | ADJ1, ADJ2 (Notes 3, 8) | | | 30 | 100 | nA |
| Shutdown Threshold | $V_{OUT} = \text{Off to On}$ | ● | | 0.80 | 1.4 | V |
| | $V_{OUT} = \text{On to Off}$ | ● | 0.25 | 0.65 | | V |
| SHDN1/SHDN2 Pin Current (Note 9) | $V_{SHDN1}, V_{SHDN2} = 0\text{V}$ | ● | | 0 | 0.5 | μA |
| | $V_{SHDN1}, V_{SHDN2} = 20\text{V}$ | ● | | 1 | 3.0 | μA |
| Quiescent Current in Shutdown | $V_{IN} = 6\text{V}$, $V_{SHDN1} = 0\text{V}$, $V_{SHDN2} = 0\text{V}$ | | | 0.01 | 0.1 | μA |
| Ripple Rejection | $V_{IN} = 2.72\text{V (Avg)}$, $V_{RIPPLE} = 0.5\text{V}_{P-P}$, $f_{RIPPLE} = 120\text{Hz}$, $I_{LOAD} = \text{Full Current}$ | | 55 | 65 | | dB |
| Current Limit | Output 2, $V_{IN2} = 7\text{V}$, $V_{OUT2} = 0\text{V}$ $V_{IN2} = 2.3\text{V}$, $\Delta V_{OUT2} = -0.1\text{V}$ | ● | 110 | 500 | | mA mA |
| | Output 1, $V_{IN1} = 7\text{V}$, $V_{OUT1} = 0\text{V}$ $V_{IN1} = 2.3\text{V}$, $\Delta V_{OUT1} = -0.1\text{V}$ | ● | 520 | 1.3 | | A mA |
| Input Reverse Leakage Current | $V_{IN} = -20\text{V}$, $V_{OUT} = 0\text{V}$ | ● | | | 1 | mA |

Note 1: Absolute Maximum Ratings are those values beyond which the life of a device may be impaired.

Note 2: The LT3028 regulator is tested and specified under pulse load conditions such that $T_J \approx T_A$. The LT3028E is guaranteed to meet performance specifications from 0°C to 125°C junction temperature. Specifications over the -40°C to 125°C operating junction temperature

range are assured by design, characterization and correlation with statistical process controls. The LT3028I is guaranteed and tested over the full -40°C to 125°C operating junction temperature range.

Note 3: The LT3028 is tested and specified for these conditions with the ADJ1/ADJ2 pin connected to the corresponding OUT1/OUT2 pin.

ELECTRICAL CHARACTERISTICS

Note 4: Operating conditions are limited by maximum junction temperature. The regulated output voltage specification will not apply for all possible combinations of input voltage and output current. When operating at maximum input voltage, the output current range must be limited. When operating at maximum output current, the input voltage range must be limited.

Note 5: To satisfy requirements for minimum input voltage, the LT3028 is tested and specified for these conditions with an external resistor divider (two 250k resistors) for an output voltage of 2.44V. The external resistor divider will add a 5µA DC load on the output.

Note 6: Dropout voltage is the minimum input to output voltage differential needed to maintain regulation at a specified output current. In dropout, the output voltage will be equal to: $V_{IN} - V_{DROPOUT}$.

Note 7: GND pin current is tested with $V_{IN} = 2.44V$ and a current source load. This means the device is tested while operating in its dropout region or at the minimum input voltage specification. This is the worst-case GND pin current. The GND pin current will decrease slightly at higher input voltages. Total GND pin current is equal to the sum of GND pin currents from Output 1 and Output 2.

Note 8: ADJ1 and ADJ2 pin bias current flows into the pin.

Note 9: SHDN1 and SHDN2 pin current flows into the pin.

Note 10: For the LT3028 dropout voltage will be limited by the minimum input voltage specification under some output voltage/load conditions. See the curve of Minimum Input Voltage in the Typical Performance Characteristics.

TYPICAL PERFORMANCE CHARACTERISTICS

**Output 2
Typical Dropout Voltage**

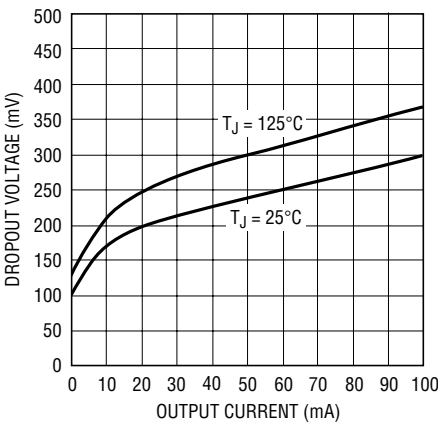

3028 G01

**Output 2
Guaranteed Dropout Voltage**

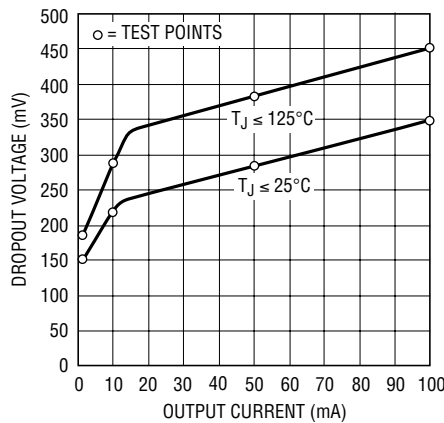

3028 G02

Output 2 Dropout Voltage

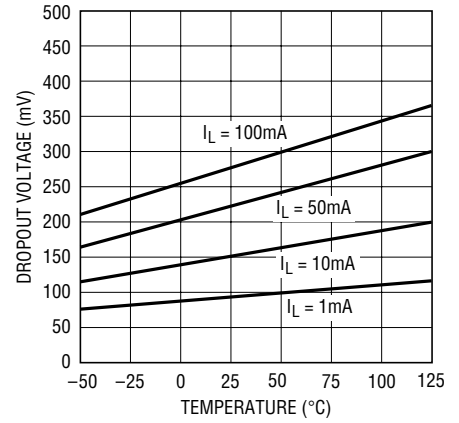

3028 G03

**Output 1
Typical Dropout Voltage**

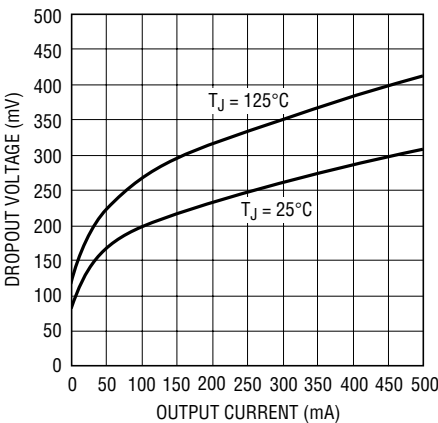

3028 G04

**Output 1
Guaranteed Dropout Voltage**

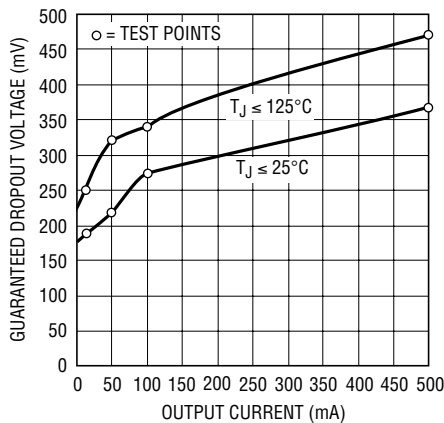

3028 G05

Output 1 Dropout Voltage

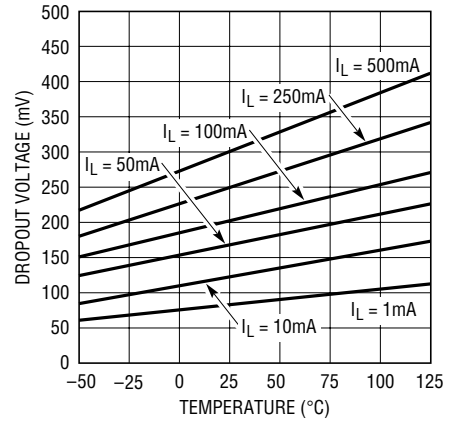

3028 G06

TYPICAL PERFORMANCE CHARACTERISTICS

Quiescent Current (Per Output)

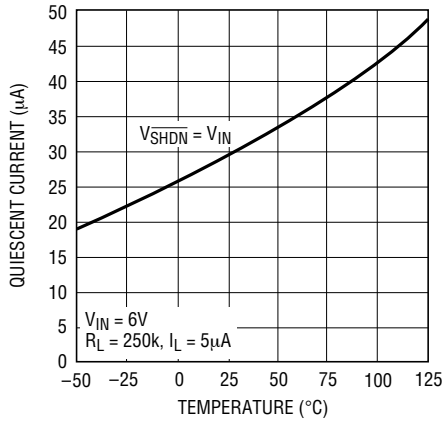

3028 G07

ADJ1 or ADJ2 Pin Voltage

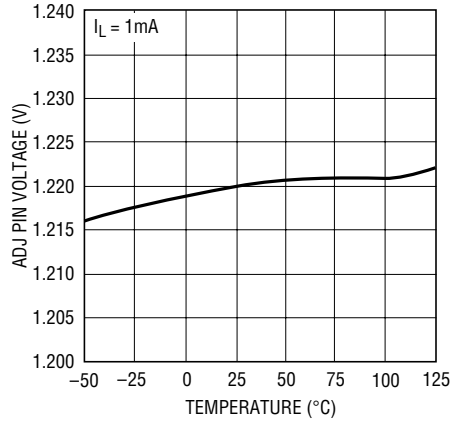

3028 G08

Quiescent Current (Per Output)

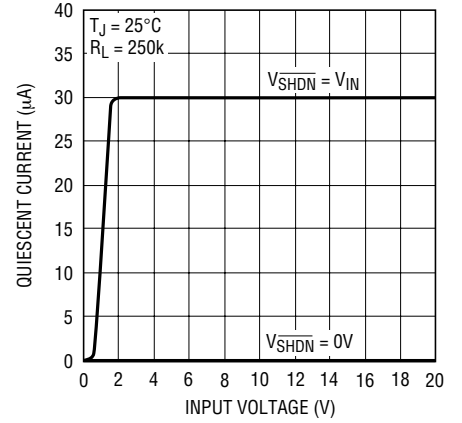

3028 G09

Output 2 GND Pin Current

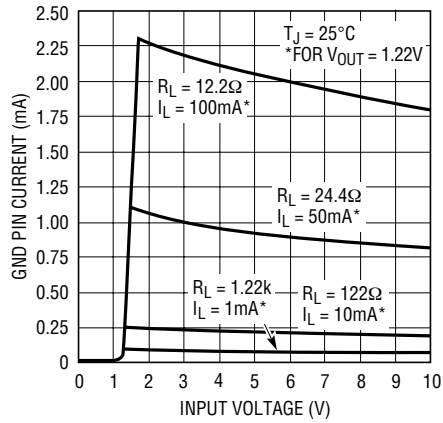

3028 G10

Output 2 GND Pin Current vs ILOAD

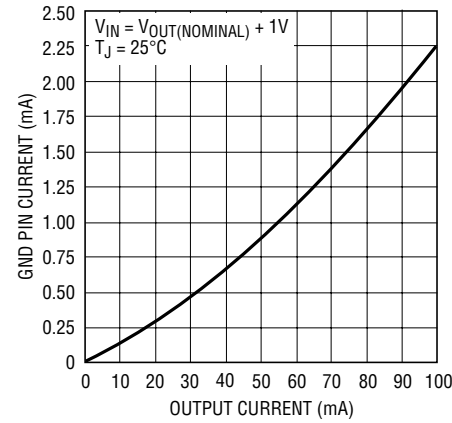

3028 G11

Output 1 GND Pin Current

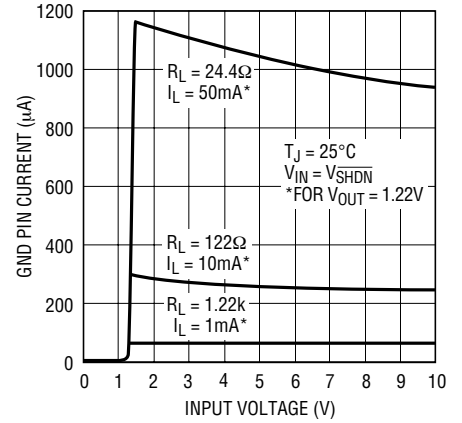

3028 G12

Output 1 GND Pin Current

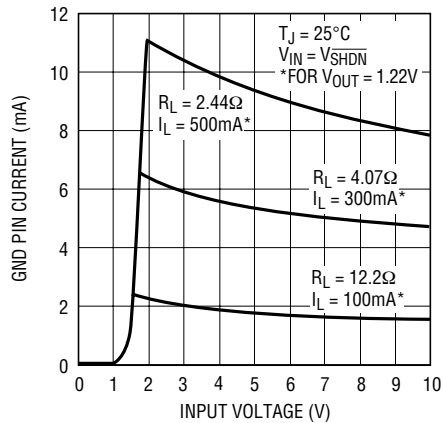

3028 G13

Output 1 GND Pin Current vs ILOAD

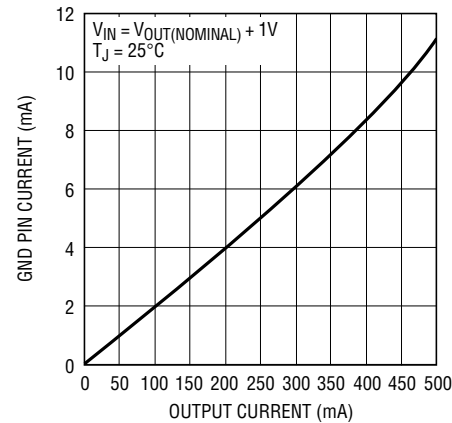

3028 G14

SHDN1 or SHDN2 Pin Threshold (On-to-Off)

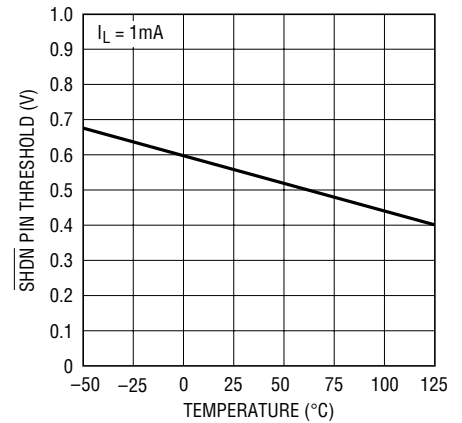

3028 G15

TYPICAL PERFORMANCE CHARACTERISTICS

SHDN1 or SHDN2 Pin Threshold (Off-to-On)

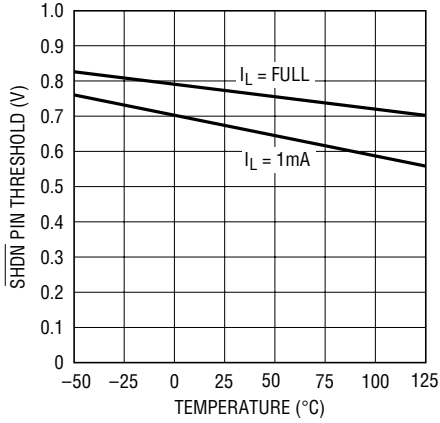

3028 G16

SHDN1 or SHDN2 Pin Input Current

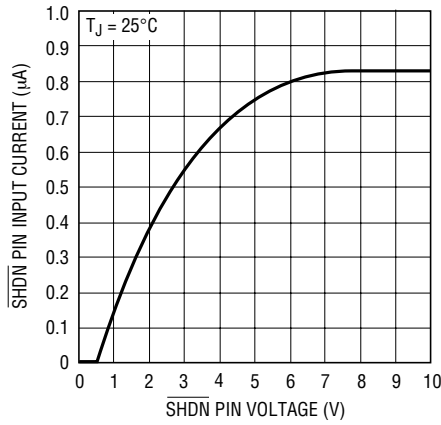

3028 G17

SHDN1 or SHDN2 Pin Input Current

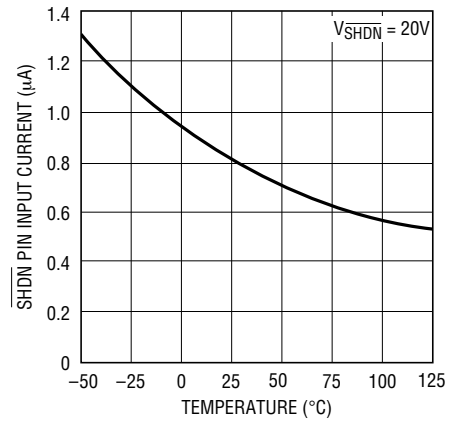

3028 G18

ADJ1 or ADJ2 Pin Bias Current

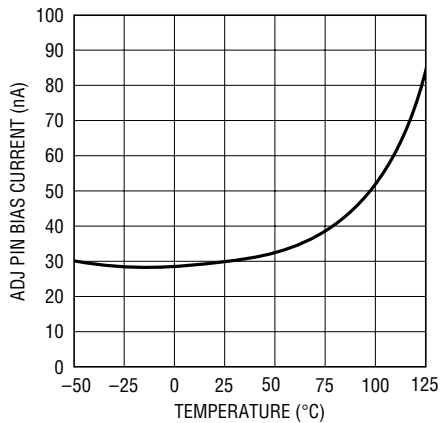

3028 G19

Output 2 Current Limit

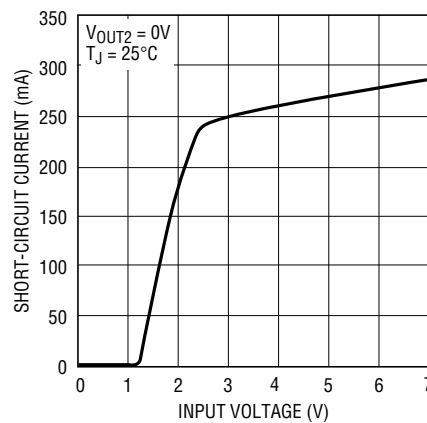

3028 G20

Output 2 Current Limit

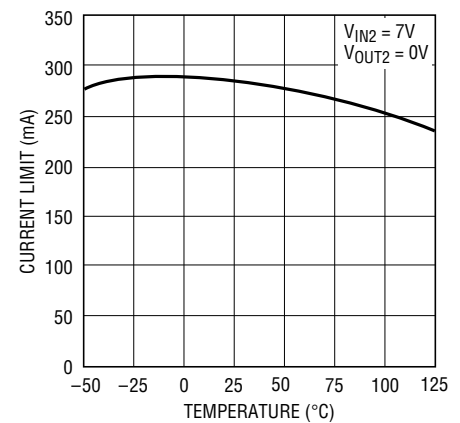

3028 G21

Output 1 Current Limit

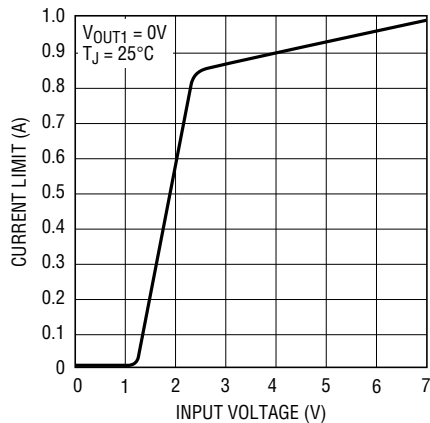

3028 G22

Output 1 Current Limit

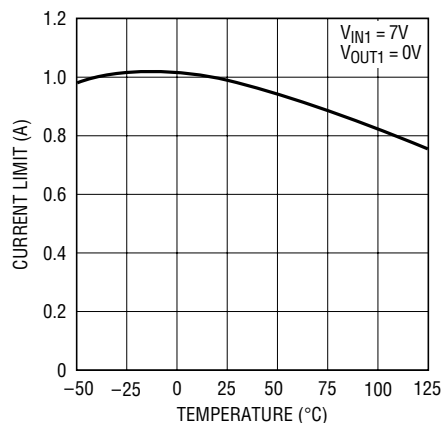

3028 G23

TYPICAL PERFORMANCE CHARACTERISTICS

**Output 2
Input Ripple Rejection**

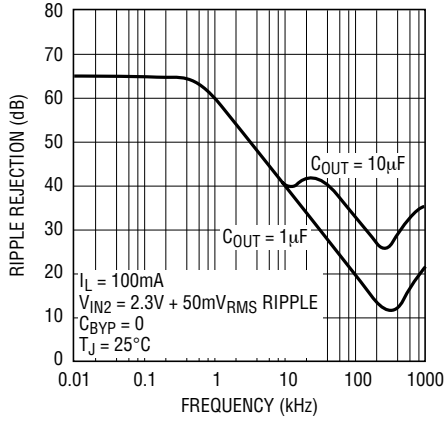

3028 G26

**Output 2
Input Ripple Rejection**

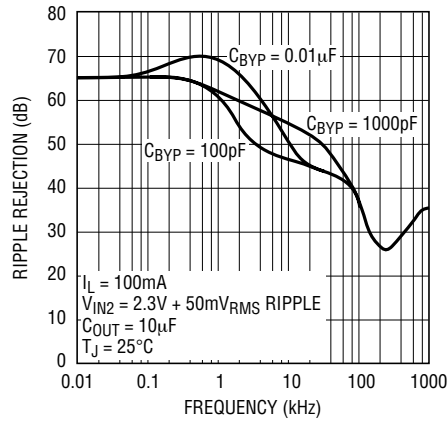

3028 G27

**Output 2
Input Ripple Rejection**

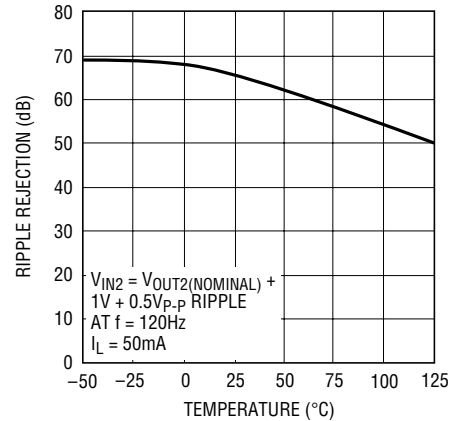

3028 G28

**Output 1
Input Ripple Rejection**

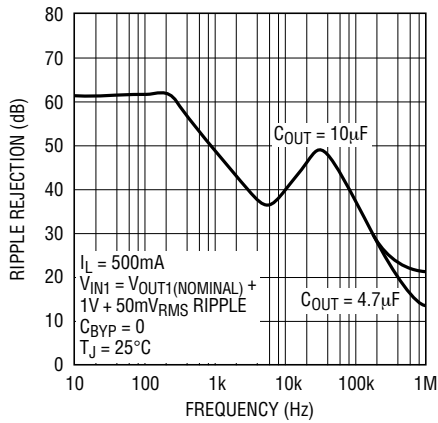

3028 G29

**Output 1
Input Ripple Rejection**

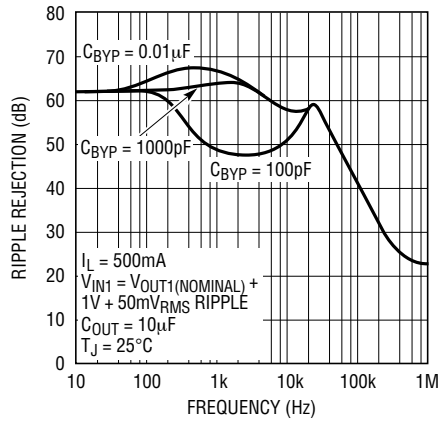

3028 G30

**Output 1
Ripple Rejection**

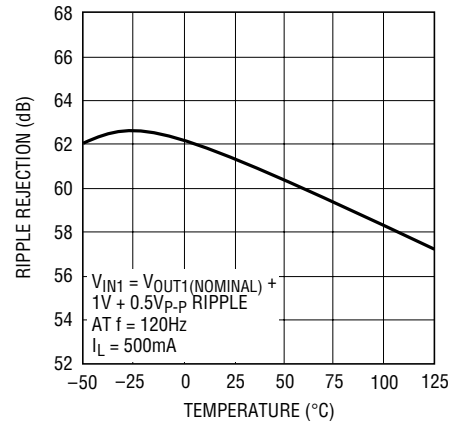

3028 G31

Output 2 Minimum Input Voltage

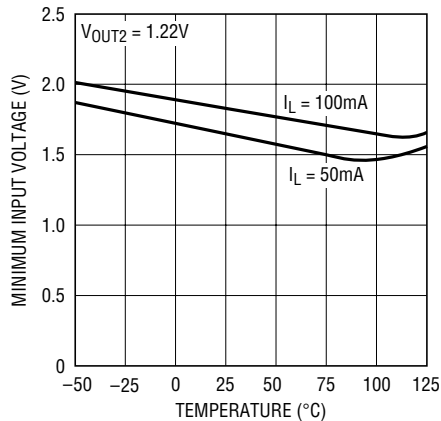

3028 G32

Output 1 Minimum Input Voltage

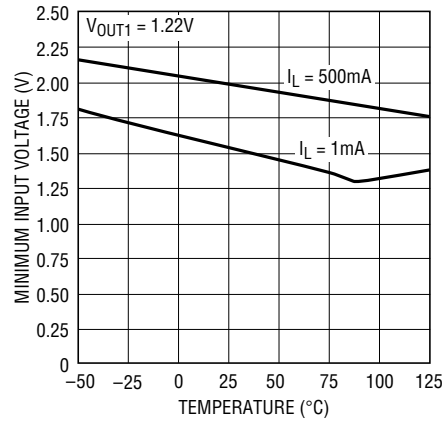

3028 G33

TYPICAL PERFORMANCE CHARACTERISTICS

Channel-to-Channel Isolation

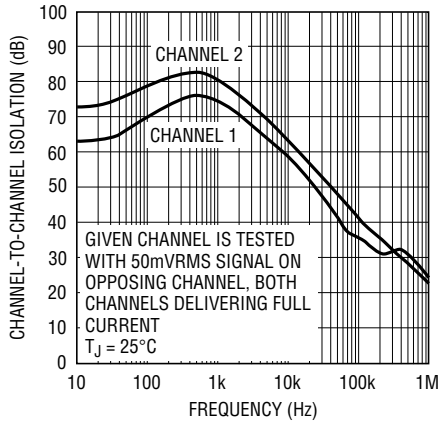

3028 G34

Channel-to-Channel Isolation

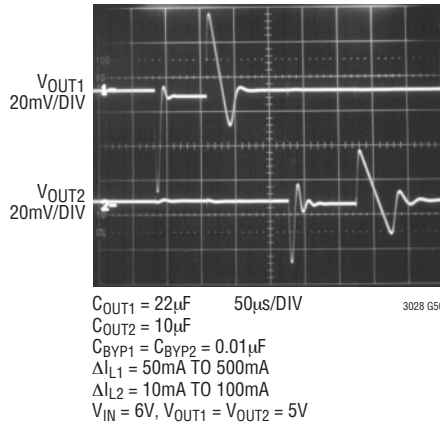

3028 G50

Output 2 Load Regulation

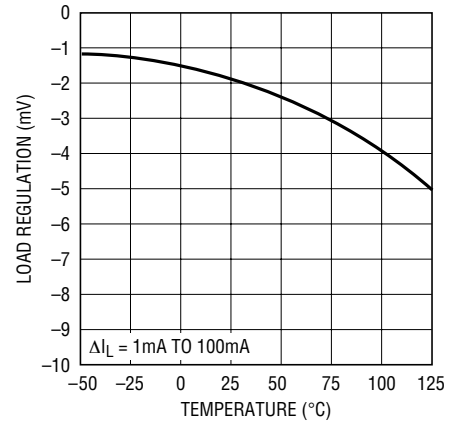

3028 G35

Output 1 Load Regulation

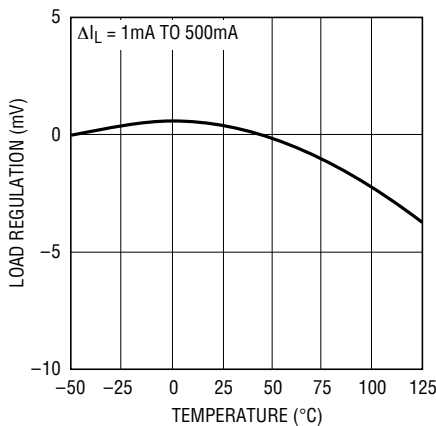

3028 G36

Output Noise Spectral Density

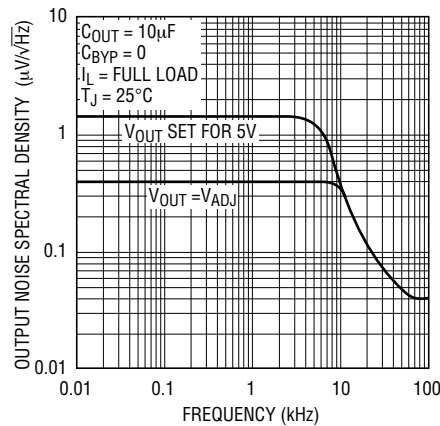

3028 G37

Output Noise Spectral Density

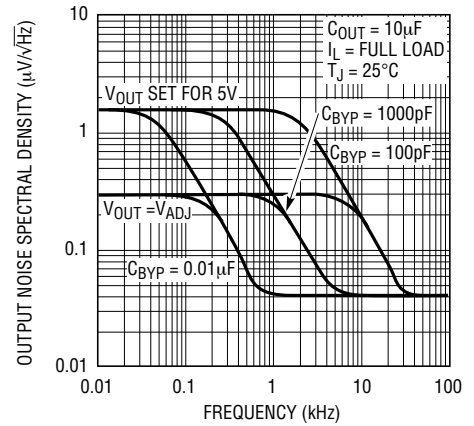

3028 G38

RMS Output Noise vs Bypass Capacitor

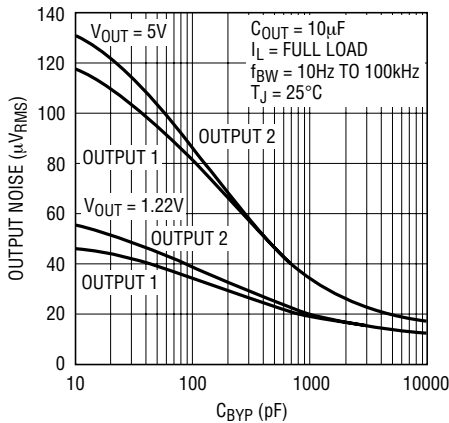

3028 G39

Output 2 RMS Output Noise vs Load Current (10Hz to 100kHz)

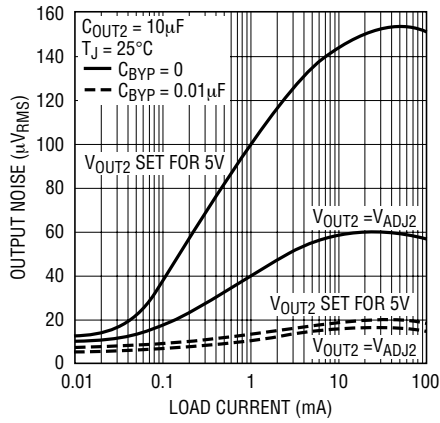

3028 G40

Output 1 RMS Output Noise vs Load Current (10Hz to 100kHz)

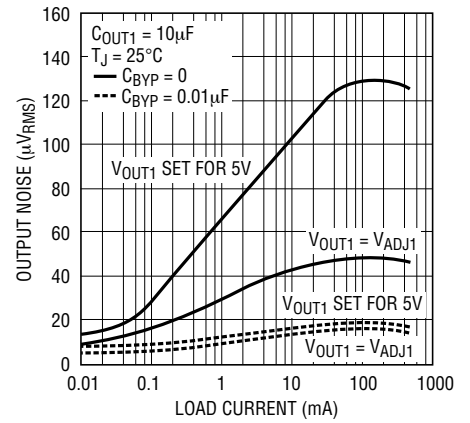

3028 G41

TYPICAL PERFORMANCE CHARACTERISTICS

10Hz to 100kHz Output Noise
 $C_{BYP} = 0pF$

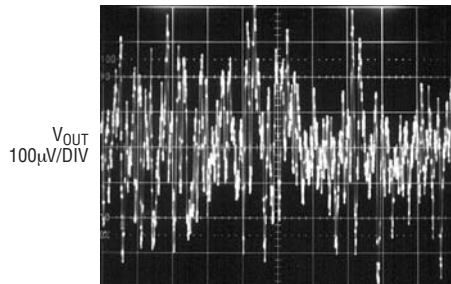

$C_{OUT} = 10\mu F$ 1ms/DIV 3028 G42
 $I_L = \text{FULL LOAD}$
 V_{OUT} SET FOR 5V

10Hz to 100kHz Output Noise
 $C_{BYP} = 100pF$

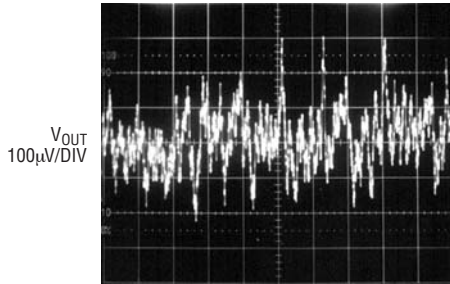

$C_{OUT} = 10\mu F$ 1ms/DIV 3028 G43
 $I_L = \text{FULL LOAD}$
 V_{OUT} SET FOR 5V

10Hz to 100kHz Output Noise
 $C_{BYP} = 1000pF$

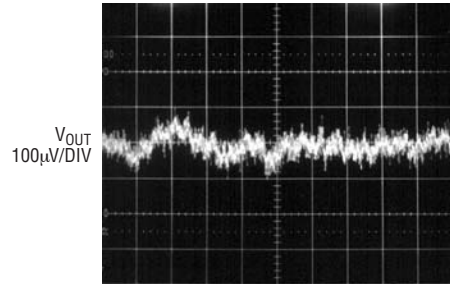

$C_{OUT} = 10\mu F$ 1ms/DIV 3028 G44
 $I_L = \text{FULL LOAD}$
 V_{OUT} SET FOR 5V

10Hz to 100kHz Output Noise
 $C_{BYP} = 0.01\mu F$

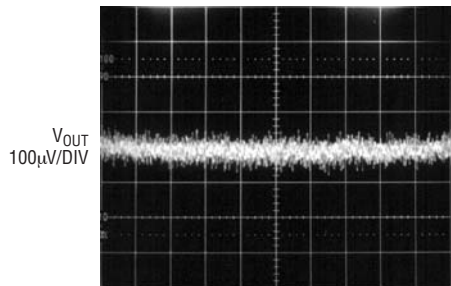

$C_{OUT} = 10\mu F$ 1ms/DIV 3028 G45
 $I_L = \text{FULL LOAD}$
 V_{OUT} SET FOR 5V

Output 2 Transient Response
 $C_{BYP} = 0pF$

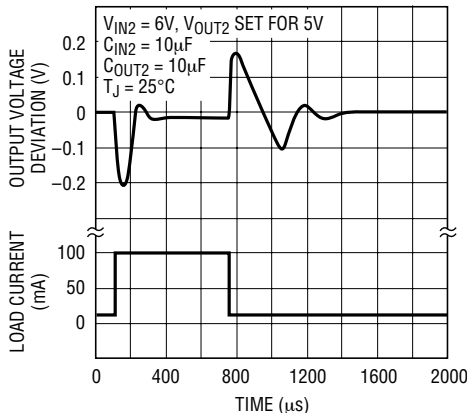

3028 G46

Output 2 Transient Response
 $C_{BYP} = 0.01\mu F$

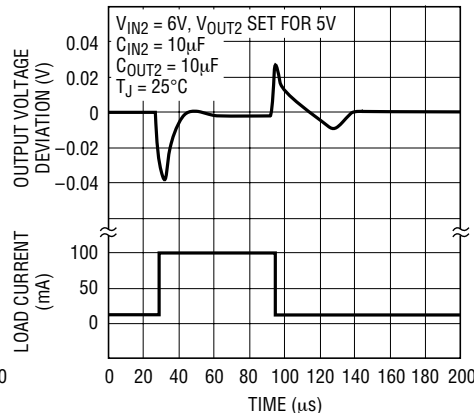

3028 G47

Output 1 Transient Response
 $C_{BYP} = 0pF$

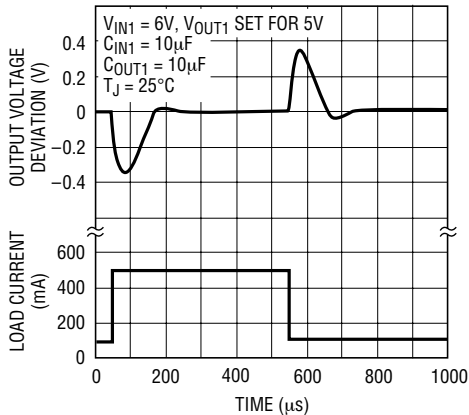

3028 G48

Output 1 Transient Response
 $C_{BYP} = 0.01\mu F$

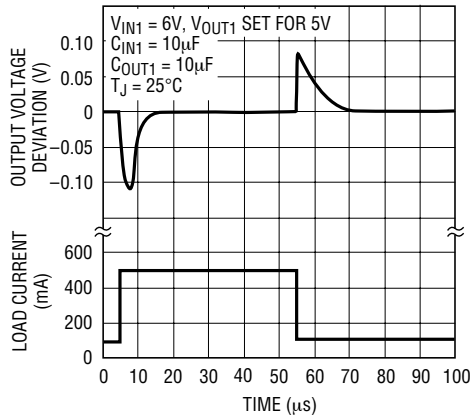

3028 G49

PIN FUNCTIONS (DFN Package)/(TSSOP Package)

GND (Pins 5, 17)/(Pins 1, 5, 8, 9, 16, 17): Ground. The Exposed Pad must be soldered to PCB ground for optimum thermal performance.

ADJ1/ADJ2 (Pins 16/9)/(Pins 15/10): Adjust Pin. These are the inputs to the error amplifiers. These pins are internally clamped to $\pm 7V$. They have a bias current of 30nA which flows into the pin (see curve of ADJ1/ADJ2 Pin Bias Current vs Temperature in the Typical Performance Characteristics section). The ADJ1 and ADJ2 pin voltage is 1.22V referenced to ground and the output voltage range is 1.22V to 20V.

BYP1/BYP2 (Pins 1/8)/(Pins 2/7): Bypass. The BYP1/BYP2 pins are used to bypass the reference of the LT3028 regulator to achieve low noise performance from the regulator. The BYP1/BYP2 pins are clamped internally to $\pm 0.6V$ (one V_{BE}) from ground. A small capacitor from the corresponding output to this pin will bypass the reference to lower the output voltage noise. A maximum value of 0.01 μF can be used for reducing output voltage noise to a typical 20 μV_{RMS} over a 10Hz to 100kHz bandwidth. If not used, this pin must be left unconnected.

OUT1/OUT2 (Pins 3, 4/6, 7)/(Pins 3, 4/6): Output. The outputs supply power to the loads. A minimum output capacitor of 1 μF is required to prevent oscillations on Output 2; Output 1 requires a minimum of 3.3 μF . Larger output capacitors will be required for applications with large transient loads to limit peak voltage transients. See the Applications Information section for more information on output capacitance and reverse output characteristics.

SHDN1/SHDN2 (Pins 15/10)/(Pins 14/11): Shutdown. The SHDN1/SHDN2 pins are used to put the corresponding output of the LT3028 regulator into a low power shutdown state. The output will be off when the pin is pulled low. The SHDN1/SHDN2 pins can be driven either by 5V logic or open-collector logic with pull-up resistors. The pull-up resistors are required to supply the pull-up current of the open-collector gates, normally several microamperes, and the SHDN1/SHDN2 pin current, typically 1 μA . If unused, the pin must be connected to V_{IN} . The device will not function if the SHDN1/SHDN2 pins are not connected.

IN1/IN2 (Pins 13, 14/11, 12)/(Pins 13/12): Inputs. Power is supplied to the device through the IN pins. A bypass capacitor is required on these pins if the device is more than six inches away from the main input filter capacitor. In general, the output impedance of a battery rises with frequency, so it is advisable to include a bypass capacitor in battery-powered circuits. A bypass capacitor in the range of 1 μF to 10 μF is sufficient. The LT3028 regulator is designed to withstand reverse voltages on the IN pins with respect to ground and the OUT pins. In the case of a reverse input, which can happen if a battery is plugged in backwards, the device will act as if there is a diode in series with its input. There will be no reverse current flow into the regulator and no reverse voltage will appear at the load. The device will protect both itself and the load.

APPLICATIONS INFORMATION

The LT3028 is a dual 100mA/500mA low dropout regulator with independent inputs, micropower quiescent current, and shutdown. The device is capable of supplying 100mA from Output 2 at a dropout voltage of 300mV. Output 1 delivers 500mA at a dropout voltage of 320mV. The two regulators have common GND pins and are thermally coupled, however, the two inputs and outputs of the LT3028 operate independently. They can be shut down

independently and a fault condition on one output will not affect the other output electrically. Output voltage noise can be lowered to 20 μV_{RMS} over a 10Hz to 100kHz bandwidth with the addition of a 0.01 μF reference bypass capacitor. Additionally, the reference bypass capacitor will improve transient response of the regulator, lowering the settling time for transient load conditions. The low operating quiescent current (30 μA per output) drops to less

APPLICATIONS INFORMATION

than $1\mu\text{A}$ in shutdown. In addition to the low quiescent current, the LT3028 regulator incorporates several protection features which make it ideal for use in battery-powered systems. The device is protected against reverse input voltages. Additionally, in dual supply applications where the regulator load is returned to a negative supply, the output can be pulled below ground by as much as 20V and still allow the device to start and operate.

Adjustable Operation

The LT3028 has an output voltage range of 1.22V to 20V. The output voltage is set by the ratio of two external resistors as shown in Figure 1. The device servos the output to maintain the corresponding ADJ pin voltage at 1.22V referenced to ground. The current in R1 is then equal to $1.22\text{V}/R1$ and the current in R2 is the current in R1 plus the ADJ pin bias current. The ADJ pin bias current, 30nA at 25°C , flows through R2 into the ADJ pin. The output voltage can be calculated using the formula in Figure 1. The value of R1 should be no greater than 250k to minimize errors in the output voltage caused by the ADJ pin bias current. Note that in shutdown the output is turned off and the divider current will be zero. Curves of ADJ Pin Voltage vs Temperature and ADJ Pin Bias Current vs Temperature appear in the Typical Performance Characteristics.

The device is tested and specified with the ADJ pin tied to the corresponding OUT pin for an output voltage of 1.22V. Specifications for output voltages greater than 1.22V will be proportional to the ratio of the desired output voltage to 1.22V: $V_{\text{OUT}}/1.22\text{V}$. For example, load regulation on Output 2 for an output current change of 1mA to 100mA

is -1mV typical at $V_{\text{OUT}} = 1.22\text{V}$. At $V_{\text{OUT}} = 12\text{V}$, load regulation is:

$$(12\text{V}/1.22\text{V})(-1\text{mV}) = -9.8\text{mV}$$

Bypass Capacitance and Low Noise Performance

The LT3028 regulator may be used with the addition of a bypass capacitor from V_{OUT} to the corresponding BYP pin to lower output voltage noise. A good quality low leakage capacitor is recommended. This capacitor will bypass the reference of the regulator, providing a low frequency noise pole. The noise pole provided by this bypass capacitor will lower the output voltage noise to as low as $20\mu\text{V}_{\text{RMS}}$ with the addition of a $0.01\mu\text{F}$ bypass capacitor. Using a bypass capacitor has the added benefit of improving transient response. With no bypass capacitor and a $10\mu\text{F}$ output capacitor, a 10mA to 100mA load step on Output 2 will settle to within 1% of its final value in less than $100\mu\text{s}$. With the addition of a $0.01\mu\text{F}$ bypass capacitor, the output will stay within 1% for the same load step. Both outputs exhibit this improvement in transient response (see Transient Reponse in Typical Performance Characteristics section). However, regulator start-up time is inversely proportional to the size of the bypass capacitor, slowing to 15ms with a $0.01\mu\text{F}$ bypass capacitor and $10\mu\text{F}$ output capacitor.

Output Capacitance and Transient Response

The LT3028 regulator is designed to be stable with a wide range of output capacitors. The ESR of the output capacitor affects stability, most notably with small capacitors. A minimum output capacitor of $1\mu\text{F}$ with an ESR of 3Ω or less is recommended for Output 2 to prevent oscillations. A minimum output capacitor of $3.3\mu\text{F}$ with an ESR of 3Ω or less is recommended for Output 1. The LT3028 is a micropower device and output transient response will be a function of output capacitance. Larger values of output capacitance decrease the peak deviations and provide improved transient response for larger load current changes. Bypass capacitors, used to decouple individual components powered by the LT3028, will increase the effective output capacitor value. With larger capacitors

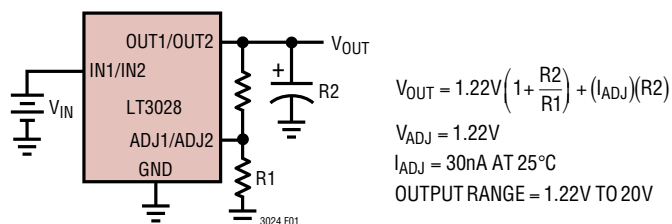

Figure 1. Adjustable Operation

APPLICATIONS INFORMATION

used to bypass the reference (for low noise operation), larger values of output capacitors are needed. For 100pF of bypass capacitance on Output 2, 2.2 μ F of output capacitor is recommended. With a 330pF bypass capacitor or larger on this output, a 3.3 μ F output capacitor is recommended. For Output 1, 4.7 μ F of output capacitor is recommended for 100pF of bypass capacitance. With 1000pF or larger bypass capacitor on this output, a 6.8 μ F output capacitor is recommended. The shaded region of Figures 2 and 3 define the regions over which the LT3028 regulator is stable. The minimum ESR needed is defined by the amount of bypass capacitance used, while the maximum ESR is 3 Ω .

Extra consideration must be given to the use of ceramic capacitors. Ceramic capacitors are manufactured with a variety of dielectrics, each with different behavior across temperature and applied voltage. The most common dielectrics used are Z5U, Y5V, X5R and X7R. The Z5U and Y5V dielectrics are good for providing high capacitances in a small package, but exhibit strong voltage and temperature coefficients as shown in Figures 4 and 5. When used with a 5V regulator, a 10 μ F Y5V capacitor can exhibit an effective value as low as 1 μ F to 2 μ F over the operating temperature range. The X5R and X7R dielectrics result in more stable characteristics and are more suitable for use as the output capacitor. The X7R type has better stability across temperature, while the X5R is less expensive and is available in higher values.

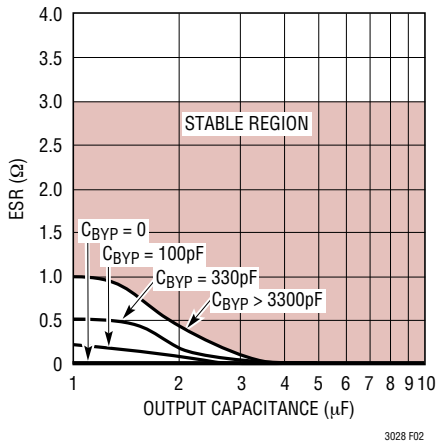

Figure 2. Output 2 Stability

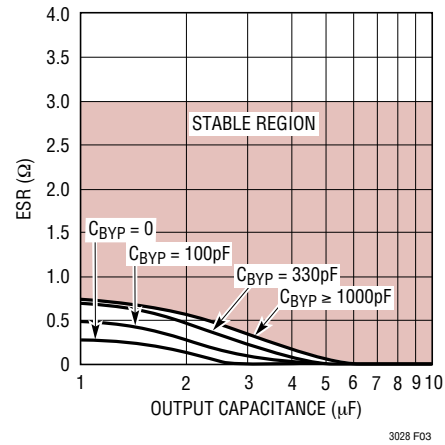

Figure 3. Output 1 Stability

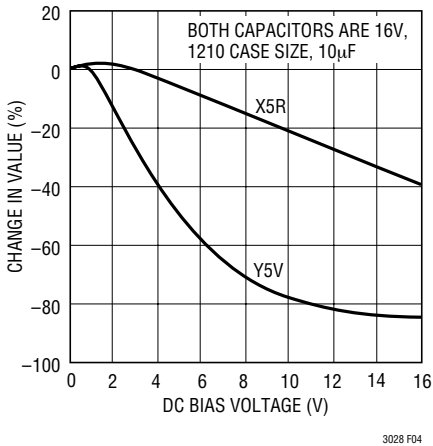

Figure 4. Ceramic Capacitor DC Bias Characteristics

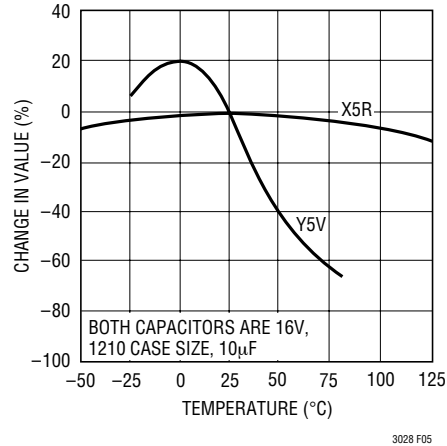

Figure 5. Ceramic Capacitor Temperature Characteristics

APPLICATIONS INFORMATION

Voltage and temperature coefficients are not the only sources of problems. Some ceramic capacitors have a piezoelectric response. A piezoelectric device generates voltage across its terminals due to mechanical stress, similar to the way a piezoelectric accelerometer or microphone works. For a ceramic capacitor the stress can be induced by vibrations in the system or thermal transients. The resulting voltages produced can cause appreciable amounts of noise, especially when a ceramic capacitor is used for noise bypassing. A ceramic capacitor produced Figure 6's trace in response to light tapping from a pencil. Similar vibration induced behavior can masquerade as increased output voltage noise.

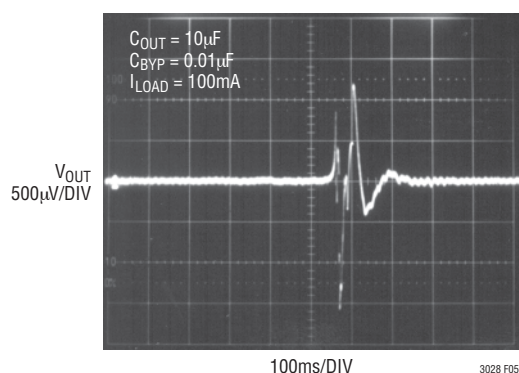

Figure 6. Noise Resulting from Tapping on a Ceramic Capacitor

Thermal Considerations

The power handling capability of the device will be limited by the maximum rated junction temperature (125°C). The power dissipated by the device will be made up of two components for each output:

1. Output current multiplied by the input/output voltage differential: $(I_{OUT})(V_{IN} - V_{OUT})$, and
2. GND pin current multiplied by the input voltage: $(I_{GND})(V_{IN})$.

The ground pin current can be found by examining the GND Pin Current curves in the Typical Performance Characteristics section. Power dissipation will be equal to the sum of the two components listed above.

The LT3028 regulator has internal thermal limiting designed to protect the device during overload conditions.

For continuous normal conditions, the maximum junction temperature rating of 125°C must not be exceeded. It is important to give careful consideration to all sources of thermal resistance from junction to ambient. Additional heat sources mounted nearby must also be considered.

For surface mount devices, heat sinking is accomplished by using the heat spreading capabilities of the PC board and its copper traces. Copper board stiffeners and plated through-holes can also be used to spread the heat generated by power devices.

The following tables list thermal resistance for several different board sizes and copper areas. All measurements were taken in still air on 3/32" FR-4 board with one ounce copper.

Table 1. FE Package, 16-Lead TSSOP

| COPPER AREA | | BOARD AREA | THERMAL RESISTANCE (JUNCTION-TO-AMBIENT) |
|---------------------|---------------------|---------------------|--|
| TOPSIDE* | BACKSIDE | | |
| 2500mm ² | 2500mm ² | 2500mm ² | 38°C/W |
| 1000mm ² | 2500mm ² | 2500mm ² | 43°C/W |
| 225mm ² | 2500mm ² | 2500mm ² | 48°C/W |
| 100mm ² | 2500mm ² | 2500mm ² | 60°C/W |

*Device is mounted on topside.

Table 2. DHC Package, 16-Lead DFN

| COPPER AREA | | BOARD AREA | THERMAL RESISTANCE (JUNCTION-TO-AMBIENT) |
|---------------------|---------------------|---------------------|--|
| TOPSIDE* | BACKSIDE | | |
| 2500mm ² | 2500mm ² | 2500mm ² | 40°C/W |
| 1000mm ² | 2500mm ² | 2500mm ² | 45°C/W |
| 225mm ² | 2500mm ² | 2500mm ² | 50°C/W |
| 100mm ² | 2500mm ² | 2500mm ² | 62°C/W |

*Device is mounted on topside.

The thermal resistance junction-to-case (θ_{JC}), measured at the Exposed Pad on the back of the die is 10°C/W for the DFN package and 8°C/W for the TSSOP package.

Calculating Junction Temperature

Example: Given Output 1 set for an output voltage of 3.3V, Output 2 set for an output voltage of 2.5V, an input voltage range of 3.8V to 5V, an output current range of 0mA to 500mA for Output 1, an output current range of 0mA to 100mA for Output 2 and a maximum ambient temperature of 50°C, what will the maximum junction temperature be?

APPLICATIONS INFORMATION

The power dissipated by each output will be equal to:

$$I_{OUT(MAX)}(V_{IN(MAX)} - V_{OUT}) + I_{GND}(V_{IN(MAX)})$$

Where for Output 1:

$$I_{OUT(MAX)} = 500\text{mA}$$

$$V_{IN(MAX)} = 5\text{V}$$

$$I_{GND} \text{ at } (I_{OUT} = 500\text{mA}, V_{IN} = 5\text{V}) = 9\text{mA}$$

For Output 2:

$$I_{OUT(MAX)} = 100\text{mA}$$

$$V_{IN(MAX)} = 5\text{V}$$

$$I_{GND} \text{ at } (I_{OUT} = 100\text{mA}, V_{IN} = 5\text{V}) = 2\text{mA}$$

So for Output 1:

$$P = 500\text{mA} (5\text{V} - 3.3\text{V}) + 9\text{mA} (5\text{V}) = 0.90\text{W}$$

For Output 2:

$$P = 100\text{mA} (5\text{V} - 2.5\text{V}) + 2\text{mA} (5\text{V}) = 0.26\text{W}$$

The thermal resistance will be in the range of 35°C/W to 55°C/W depending on the copper area. So the junction temperature rise above ambient will be approximately equal to:

$$(0.90\text{W} + 0.26\text{W}) 50^\circ\text{C}/\text{W} = 57.8^\circ\text{C}$$

The maximum junction temperature will then be equal to the maximum junction temperature rise above ambient plus the maximum ambient temperature or:

$$T_{JMAX} = 50^\circ\text{C} + 57.8^\circ\text{C} = 107.8^\circ\text{C}$$

Protection Features

The LT3028 regulator incorporates several protection features which make it ideal for use in battery-powered circuits. In addition to the normal protection features associated with monolithic regulators, such as current limiting and thermal limiting, the device is protected against reverse input voltages and reverse voltages from output to input. The two regulators have common inputs and GND pins and are thermally coupled, however, the two outputs of the LT3028 operate independently. They can be shut down independently and a fault condition on one output will not affect the other output electrically.

Current limit protection and thermal overload protection are intended to protect the device against current overload conditions at the output of the device. For normal operation, the junction temperature should not exceed 125°C.

The input of the device will withstand reverse voltages of 20V. Current flow into the device will be limited to less than 1mA (typically less than 100µA) and no negative voltage will appear at the output. The device will protect both itself and the load. This provides protection against batteries which can be plugged in backward.

The output of the LT3028 can be pulled below ground without damaging the device. If the input is left open circuit or grounded, the output can be pulled below ground by 20V. The output will act like an open circuit; no current will flow out of the pin. If the input is powered by a voltage source, the output will source the short-circuit current of the device and will protect itself by thermal limiting. In this case, grounding the SHDN1/SHDN2 pins will turn off the device and stop the output from sourcing the short-circuit current.

The ADJ pins can be pulled above or below ground by as much as 7V without damaging the device. If the input is left open circuit or grounded, the ADJ pins will act like an open circuit when pulled below ground and like a large resistor (typically 100k) in series with a diode when pulled above ground.

In situations where the ADJ pins are connected to a resistor divider that would pull the pins above their 7V clamp voltage if the output is pulled high, the ADJ pin input current must be limited to less than 5mA. For example, a resistor divider is used to provide a regulated 1.5V output from the 1.22V reference when the output is forced to 20V. The top resistor of the resistor divider must be chosen to limit the current into the ADJ pin to less than 5mA when the ADJ pin is at 7V. The 13V difference between output and ADJ pin divided by the 5mA maximum current into the ADJ pin yields a minimum top resistor value of 2.6k.

APPLICATIONS INFORMATION

In circuits where a backup battery is required, several different input/output conditions can occur. The output voltage may be held up while the input is either pulled to ground, pulled to some intermediate voltage or is left open circuit.

When the IN pin of the LT3028 is forced below either OUT pin or either OUT pin is pulled above the IN pin, input current

for the corresponding regulator will typically drop to less than 2µA. This can happen if the input of the device is connected to a discharged (low voltage) battery and the output is held up by either a backup battery or a second regulator circuit. The state of the SHDN1/SHDN2 pin will have no effect on the reverse output current when the output is pulled above the input.

PACKAGE DESCRIPTION

FE Package
16-Lead Plastic TSSOP (4.4mm)
 (Reference LTC DWG # 05-08-1663)

Exposed Pad Variation BB

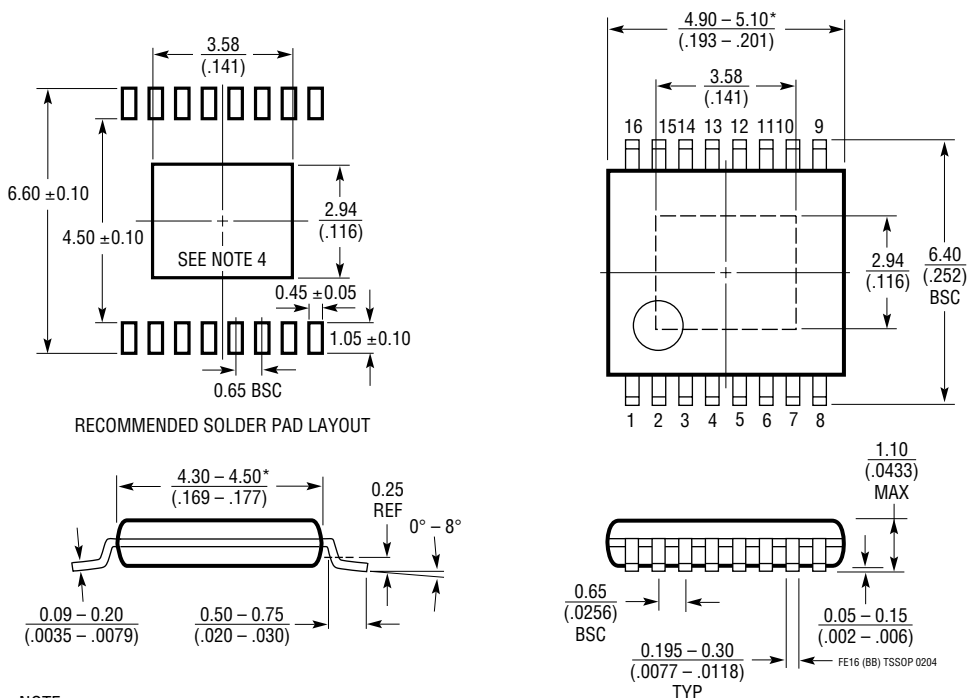

- NOTE:
1. CONTROLLING DIMENSION: MILLIMETERS
 2. DIMENSIONS ARE IN MILLIMETERS (INCHES)
 3. DRAWING NOT TO SCALE
 4. RECOMMENDED MINIMUM PCB METAL SIZE FOR EXPOSED PAD ATTACHMENT
- *DIMENSIONS DO NOT INCLUDE MOLD FLASH. MOLD FLASH SHALL NOT EXCEED 0.150mm (.006") PER SIDE

PACKAGE DESCRIPTION

DHC Package
16-Lead Plastic DFN (5mm × 3mm)
 (Reference LTC DWG # 05-08-1706)

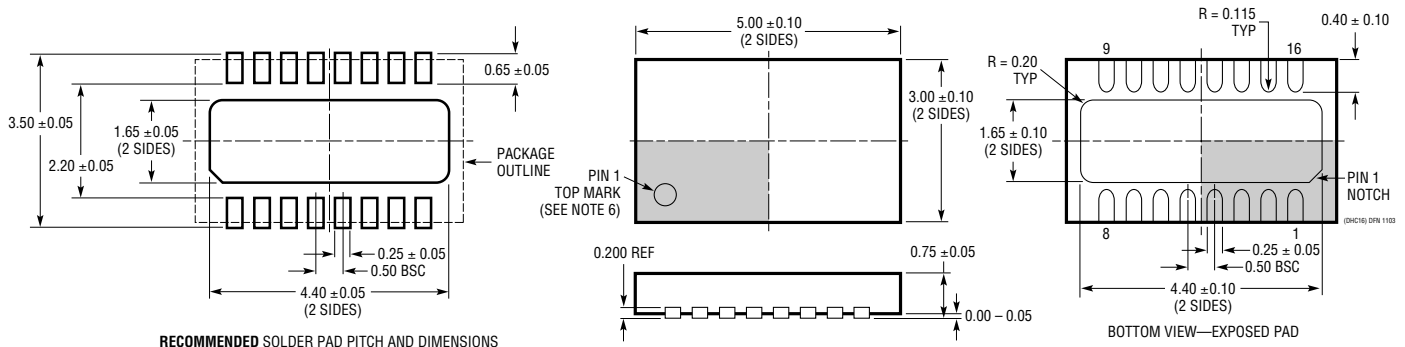

NOTE:
 1. DRAWING PROPOSED TO BE MADE VARIATION OF VERSION (WJED-1) IN JEDEC PACKAGE OUTLINE MO-229
 2. DRAWING NOT TO SCALE
 3. ALL DIMENSIONS ARE IN MILLIMETERS

4. DIMENSIONS OF EXPOSED PAD ON BOTTOM OF PACKAGE DO NOT INCLUDE MOLD FLASH. MOLD FLASH, IF PRESENT, SHALL NOT EXCEED 0.15mm ON ANY SIDE
 5. EXPOSED PAD SHALL BE SOLDER PLATED
 6. SHADED AREA IS ONLY A REFERENCE FOR PIN 1 LOCATION ON THE TOP AND BOTTOM OF PACKAGE

RELATED PARTS

| PART NUMBER | DESCRIPTION | COMMENTS |
|----------------|---|---|
| LT1129 | 700mA, Micropower, LDO | V_{IN} : 4.2V to 30V, $V_{OUT(MIN)}$ = 3.75V, I_Q = 50 μ A, I_{SD} < 16 μ A, DD, SOT-223, S8, TO220, TSSOP20 Packages |
| LT1175 | 500mA, Micropower Negative LDO | Guaranteed Voltage Tolerance and Line/Load Regulation V_{IN} : -20V to -4.3V, $V_{OUT(MIN)}$ = -3.8V, I_Q = 45 μ A, I_{SD} < 10 μ A, DD, SOT-223, S8 Packages |
| LT1185 | 3A, Negative LDO | Accurate Programmable Current Limit, Remote Sense V_{IN} : -35V to -4.2V, $V_{OUT(MIN)}$ = -2.40V, I_Q = 2.5mA, I_{SD} < 1 μ A, TO220-5 Package |
| LT1761 | 100mA, Low Noise Micropower, LDO | Low Noise < 20 μ V _{RMS} , Stable with 1 μ F Ceramic Capacitors, V_{IN} : 1.8V to 20V, $V_{OUT(MIN)}$ = 1.22V, I_Q = 20 μ A, I_{SD} < 1 μ A, ThinSOT Package |
| LT1762 | 150mA, Low Noise Micropower, LDO | Low Noise < 20 μ V _{RMS} , V_{IN} : 1.8V to 20V, $V_{OUT(MIN)}$ = 1.22V, I_Q = 25 μ A, I_{SD} < 1 μ A, MS8 Package |
| LT1763 | 500mA, Low Noise Micropower, LDO | Low Noise < 20 μ V _{RMS} , V_{IN} : 1.8V to 20V, $V_{OUT(MIN)}$ = 1.22V, I_Q = 30 μ A, I_{SD} < 1 μ A, S8 Package |
| LT1764/LT1764A | 3A, Low Noise, Fast Transient Response, LDO | Low Noise < 40 μ V _{RMS} , "A" Version Stable with Ceramic Capacitors, V_{IN} : 2.7V to 20V, $V_{OUT(MIN)}$ = 1.21V, I_Q = 1mA, I_{SD} < 1 μ A, DD, TO220 Packages |
| LTC1844 | 150mA, Very Low Drop-Out LDO | Low Noise < 30 μ V _{RMS} , Stable with 1 μ F Ceramic Capacitors, V_{IN} : 1.6V to 6.5V, $V_{OUT(MIN)}$ = 1.25V, I_Q = 40 μ A, I_{SD} < 1 μ A, ThinSOT Package |
| LT1962 | 300mA, Low Noise Micropower, LDO | Low Noise < 20 μ V _{RMS} , V_{IN} : 1.8V to 20V, $V_{OUT(MIN)}$ = 1.22V, I_Q = 30 μ A, I_{SD} < 1 μ A, MS8 Package |
| LT1963/LT1963A | 1.5A, Low Noise, Fast Transient Response, LDO | Low Noise < 40 μ V _{RMS} , "A" Version Stable with Ceramic Capacitors, V_{IN} : 2.1V to 20V, $V_{OUT(MIN)}$ = 1.21V, I_Q = 1mA, I_{SD} < 1 μ A, DD, TO220, SOT-223, S8 Packages |
| LT1964 | 200mA, Low Noise Micropower, Negative LDO | Low Noise < 30 μ V _{RMS} , Stable with Ceramic Capacitors, V_{IN} : -0.9V to -20V, $V_{OUT(MIN)}$ = -1.21V, I_Q = 30 μ A, I_{SD} < 3 μ A, ThinSOT Package |
| LT3023 | Dual 100mA, Low Noise, Micropower LDO | Low Noise < 20 μ V _{RMS} , Stable with 1 μ F Ceramic Capacitors, V_{IN} : 1.8V to 20V, $V_{OUT(MIN)}$ = 1.22V, I_Q = 40 μ A, I_{SD} < 1 μ A, MS10E, DFN Packages |
| LT3024 | Dual 100mA/500mA, Low Noise, Micropower LDO | Low Noise < 20 μ V _{RMS} , Stable with 1 μ F Ceramic Capacitors, V_{IN} : 1.8V to 20V, $V_{OUT(MIN)}$ = 1.22V, I_Q = 30 μ A, I_{SD} < 1 μ A, DFN, TSSOP Packages |

Looking for pricing, stock, or lifecycle information?

Click below to explore more details on WIN SOURCE:

- ⊖ [View LT3028EDHC#TRPBF on WIN SOURCE](#)
- ⊖ [Analog Devices Inc. Information](#)

Optimize Your Supply Chain with WIN SOURCE Solutions

- ✓ Global Sourcing Solution
- ✓ Obsolete Management
- ✓ Cost Control Management
- ✓ Shortage Management
- ✓ Alternative Solution
- ✓ Excess Inventory Management