



# THE DATASHEET OF MAX4252ESA-T



Click [here](#) to ask an associate for production status of specific part numbers.

## UCSP, Single-Supply, Low-Noise, Low-Distortion, Rail-to-Rail Op Amps

## MAX4249–MAX4257

### General Description

The MAX4249–MAX4257 low-noise, low-distortion operational amplifiers offer rail-to-rail outputs and single-supply operation down to 2.4V. They draw 400 $\mu$ A of quiescent supply current per amplifier while featuring ultra-low distortion (0.0002% THD), as well as low input voltage-noise density (7.9nV/ $\sqrt{\text{Hz}}$ ) and low input current-noise density (0.5fA/ $\sqrt{\text{Hz}}$ ). These features make the devices an ideal choice for portable/battery-powered applications that require low distortion and/or low noise.

For additional power conservation, the MAX4249/MAX4251/MAX4253/MAX4256 offer a low-power shutdown mode that reduces supply current to 0.5 $\mu$ A and puts the amplifiers' outputs into a high-impedance state. The MAX4249–MAX4257's outputs swing rail-to-rail and their input common-mode voltage range includes ground. The MAX4250–MAX4254 are unity-gain stable with a gain-bandwidth product of 3MHz. The MAX4249/MAX4255/MAX4256/MAX4257 are internally compensated for gains of 10V/V or greater with a gain-bandwidth product of 22MHz. The single MAX4250/MAX4255 are available in space-saving 5-pin SOT23 packages. The MAX4252 is available in an 8-bump chip-scale package (UCSP™) and the MAX4253 is available in a 10-bump UCSP. The MAX4250AAUK comes in a 5-pin SOT23 package and is specified for operation over the automotive (-40°C to +125°C) temperature range.

### Applications

- Wireless Communications Devices
- PA Control
- Portable/Battery-Powered Equipment
- Medical Instrumentation
- ADC Buffers
- Digital Scales/Strain Gauges

### Pin/Bump Configurations

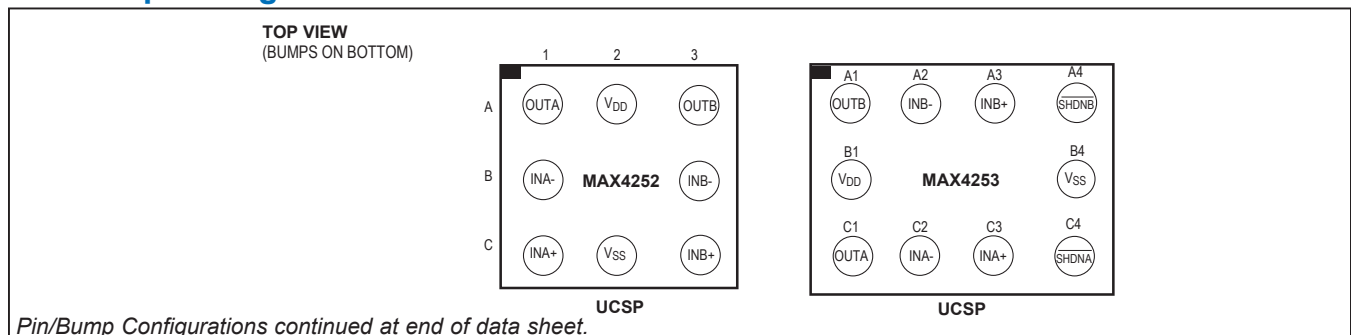

### Features

- Available in Space-Saving UCSP, SOT23, and  $\mu$ MAX® Packages
- Low Distortion: 0.0002% THD (1k $\Omega$  load)
- 400 $\mu$ A Quiescent Supply Current per Amplifier
- Single-Supply Operation from 2.4V to 5.5V
- Input Common-Mode Voltage Range Includes Ground
- Outputs Swing Within 8mV of Rails with a 10k $\Omega$  Load
- 3MHz GBW Product, Unity-Gain Stable (MAX4250–MAX4254)
  - 22MHz GBW Product, Stable with  $A_V \geq 10V/V$  (MAX4249/MAX4255/MAX4256/MAX4257)
- Excellent DC Characteristics
  - $V_{OS} = 70\mu V$
  - $I_{BIAS} = 1pA$
  - Large-Signal Voltage Gain = 116dB
- Low-Power Shutdown Mode
  - Reduces Supply Current to 0.5 $\mu$ A
  - Places Outputs in a High-Impedance State
- 400pF Capacitive-Load Handling Capability

### Ordering Information

PART	TEMP RANGE	PIN-PACKAGE	TOP MARK
MAX4249ESD+	-40°C to +85°C	14 SO	—
MAX4249EUB+	-40°C to +85°C	10 $\mu$ MAX	—
MAX4250EUK+T	-40°C to +85°C	5 SOT23	ACCI
MAX4250AAUK+T	-40°C to +125°C	5 SOT23	AEYJ

+Denotes a lead(Pb)-free/RoHS-compliant package.

T = Tape and reel.

Ordering Information continued at end of data sheet.

Selector Guide appears at end of data sheet.

### Absolute Maximum Ratings

Power-Supply Voltage ( $V_{DD}$  to  $V_{SS}$ ).....+6.0V to -0.3V  
 Analog Input Voltage ( $IN_+$ ,  $IN_-$ ). ( $V_{DD} + 0.3V$ ) to ( $V_{SS} - 0.3V$ )  
 $\overline{SHDN}$  Input Voltage .....6.0V to ( $V_{SS} - 0.3V$ )  
 Output Short-Circuit Duration to Either Supply .....Continuous  
 Continuous Power Dissipation ( $T_A = +70^\circ C$ )  
     5-Pin SOT23 (derate 7.1mW/ $^\circ C$  above  $+70^\circ C$ ) .....571mW  
     8-Bump UCSP (derate 4.7mW/ $^\circ C$  above  $+70^\circ C$ ).....379mW  
     8-Pin  $\mu$ MAX (derate 4.5mW/ $^\circ C$  above  $+70^\circ C$ ).....362mW  
     8-Pin SO (derate 5.88mW/ $^\circ C$  above  $+70^\circ C$ ).....471mW  
     10-Bump UCSP (derate 6.1mW/ $^\circ C$  above  $+70^\circ C$ ).....484mW

10-Pin  $\mu$ MAX (derate 5.6mW/ $^\circ C$  above  $+70^\circ C$ ).....444mW  
 14-Pin SO (derate 8.33mW/ $^\circ C$  above  $+70^\circ C$ ).....667mW  
 Operating Temperature Range.....  $-40^\circ C$  to  $+85^\circ C$   
 MAX4250AAUK .....  $-40^\circ C$  to  $+125^\circ C$   
 Junction Temperature.....  $+150^\circ C$   
 Storage Temperature Range.....  $-65^\circ C$  to  $+150^\circ C$   
 Lead Temperature (soldering, 10s) .....  $+300^\circ C$   
 Soldering Temperature (reflow).....  $+260^\circ C$

Stresses beyond those listed under "Absolute Maximum Ratings" may cause permanent damage to the device. These are stress ratings only, and functional operation of the device at these or any other conditions beyond those indicated in the operational sections of the specifications is not implied. Exposure to absolute maximum rating conditions for extended periods may affect device reliability.

### Electrical Characteristics

( $V_{DD} = 5V$ ,  $V_{SS} = 0V$ ,  $V_{CM} = 0V$ ,  $V_{OUT} = V_{DD}/2$ ,  $R_L$  connected to  $V_{DD}/2$ ,  $\overline{SHDN} = V_{DD}$ ,  $T_A = T_{MIN}$  to  $T_{MAX}$ , unless otherwise noted. Typical values are at  $T_A = +25^\circ C$ .) (Notes 2, 3)

PARAMETER	SYMBOL	CONDITIONS		MIN	TYP	MAX	UNITS	
Supply Voltage Range	$V_{DD}$	(Note 4)		2.4		5.5	V	
Quiescent Supply Current Per Amplifier	$I_Q$	Normal mode	$V_{DD} = 3V$		400		$\mu A$	
			$V_{DD} = 5V$	E temperature		420		575
				MAX4250AAUK				675
		$V_{DD} = 5V$ , UCSP only		420	655			
		Shutdown mode ( $\overline{SHDN} = V_{SS}$ ) (Note 2)			0.5	1.5		
Input Offset Voltage (Note 5)	$V_{OS}$	E temperature			$\pm 0.07$	$\pm 0.75$	mV	
		MAX4250AAUK				$\pm 1.85$		
Input Offset Voltage Tempco	$TCV_{OS}$				0.3		$\mu V/^\circ C$	
Input Bias Current	$I_B$	(Note 6)	$T_A = +25^\circ C$		0.1	1	pA	
			$T_A = -40^\circ C$ to $+85^\circ C$			50		
			$T_A = -40^\circ C$ to $+125^\circ C$			1500		
Input Offset Current	$I_{OS}$	(Note 6)	$T_A = +25^\circ C$		0.1	1	pA	
			$T_A = -40^\circ C$ to $+85^\circ C$			10		
			$T_A = -40^\circ C$ to $+125^\circ C$			100		
Differential Input Resistance	$R_{IN}$				1000		G $\Omega$	
Input Common-Mode Voltage Range	$V_{CM}$	Guaranteed by CMRR test	E temperature	-0.2		$V_{DD} - 1.1$	V	
			MAX4250AAUK	0		$V_{DD} - 1.1$		
Common-Mode Rejection Ratio	CMRR	$V_{SS} - 0.2V \leq V_{CM} \leq V_{DD} - 1.1V$	E temperature	70	115		dB	
			MAX4250AAUK	68				

Electrical Characteristics (continued)

( $V_{DD} = 5V$ ,  $V_{SS} = 0V$ ,  $V_{CM} = 0V$ ,  $V_{OUT} = V_{DD}/2$ ,  $R_L$  connected to  $V_{DD}/2$ ,  $\overline{SHDN} = V_{DD}$ ,  $T_A = T_{MIN}$  to  $T_{MAX}$ , unless otherwise noted. Typical values are at  $T_A = +25^\circ C$ .) (Notes 2, 3)

PARAMETER	SYMBOL	CONDITIONS		MIN	TYP	MAX	UNITS
Power-Supply Rejection Ratio	PSRR	$V_{DD} - 2.4V$ to $5.5V$	E temperature	75	100		dB
			MAX4250AAUK	72			
Large-Signal Voltage Gain	$A_V$	$R_L = 10k\Omega$ to $V_{DD}/2$ ; $V_{OUT} = 25mV$ to $V_{DD} - 4.97V$	E temperature	80	116		dB
			MAX4250AAUK	77			
		$R_L = 1k\Omega$ to $V_{DD}/2$ ; $V_{OUT} = 150mV$ to $V_{DD} - 4.75V$	E temperature	80	112		
			MAX4250AAUK	77			
Output Voltage Swing	$V_{OUT}$	$ V_{IN+} - V_{IN-}  \geq 10mV$ ; $R_L = 10k\Omega$ to $V_{DD}/2$	$V_{DD} - V_{OH}$	E	8	25	mV
				A		30	
			$V_{OL} - V_{SS}$	E	7	20	
				A		25	
Output Voltage Swing	$V_{OUT}$	$ V_{IN+} - V_{IN-}  \geq 10mV$ ; $R_L = 1k\Omega$ to $V_{DD}/2$	$V_{DD} - V_{OH}$	E	77	200	mV
				A		225	
			$V_{OL} - V_{SS}$	E	47	100	
				A		125	
Output Short-Circuit Current	$I_{SC}$			68		mA	
Output Leakage Current	$I_{LEAK}$	Shutdown mode ( $\overline{SHDN} = V_{SS}$ ), $V_{OUT} = V_{SS}$ to $V_{DD}$ (Note 2)			0.001	1.0	$\mu A$
$\overline{SHDN}$ Logic Low	$V_{IL}$	(Note 2)				$0.2 \times V_{DD}$	V
$\overline{SHDN}$ Logic High	$V_{IH}$	(Note 2)		$0.8 \times V_{DD}$			V
$\overline{SHDN}$ Input Current	$I_{IL}/I_{IH}$	$\overline{SHDN} = V_{SS} = V_{DD}$ (Note 2)			0.5	1.5	$\mu A$
Input Capacitance					11		pF
Gain-Bandwidth Product	GBW	MAX4250–MAX4254			3		MHz
		MAX4249/MAX4255/MAX4256/MAX4257			22		
Slew Rate	SR	MAX4250–MAX4254			0.3		V/ $\mu s$
		MAX4249/MAX4255/MAX4256/MAX4257			2.1		
Peak-to-Peak Input-Noise Voltage	$e_{nP-P}$	$f = 0.1Hz$ to $10Hz$			760		nV $_{P-P}$
Input Voltage-Noise Density	$e_n$	$f = 10Hz$			27		nV/ $\sqrt{Hz}$
		$f = 1kHz$			8.9		
		$f = 30kHz$			7.9		
Input Current-Noise Density	$i_n$	$f = 1kHz$			0.5		fA/ $\sqrt{Hz}$

Electrical Characteristics (continued)

( $V_{DD} = 5V$ ,  $V_{SS} = 0V$ ,  $V_{CM} = 0V$ ,  $V_{OUT} = V_{DD}/2$ ,  $R_L$  connected to  $V_{DD}/2$ ,  $\overline{SHDN} = V_{DD}$ ,  $T_A = T_{MIN}$  to  $T_{MAX}$ , unless otherwise noted. Typical values are at  $T_A = +25^\circ C$ .) (Notes 2, 3)

PARAMETER	SYMBOL	CONDITIONS		MIN	TYP	MAX	UNITS
Total Harmonic Distortion Plus Noise	THD+N	MAX4250–MAX4254 $A_V = 1V/V$ , $V_{OUT} = 2V_{P-P}$ , $R_L = 1k\Omega$ to GND (Note 7)	$f = 1kHz$		0.0004		%
			$f = 20kHz$		0.006		
		MAX4249/MAX4255/ MAX4256/MAX4257 $A_V = 1V/V$ , $V_{OUT} = 2V_{P-P}$ , $R_L = 1k\Omega$ to GND (Note 7)	$f = 1kHz$		0.0012		
			$f = 20kHz$		0.007		
Capacitive-Load Stability		No sustained oscillations			400		pF
Gain Margin	GM	MAX4250–MAX4254, $A_V = 1V/V$			10		dB
		MAX4249/MAX4255/MAX4256/MAX4257, $A_V = 10V/V$			12.5		
Phase Margin	$\Phi M$	MAX4250–MAX4254, $A_V = 1V/V$			74		Degrees
		MAX4249/MAX4255/MAX4256/MAX4257, $A_V = 10V/V$			68		
Settling Time		To 0.01%, $V_{OUT} = 2V$ step	MAX4250–MAX4254		6.7		$\mu s$
			MAX4249/MAX4255/ MAX4256/MAX4257		1.6		
Delay Time to Shutdown	$t_{SH}$	$I_{VDD} = 5\%$ of normal operation	MAX4251/MAX4253		0.8		$\mu s$
			MAX4249/MAX4256		1.2		
Delay Time to Enable	$t_{EN}$	$V_{OUT} = 2.5V$ , $V_{OUT}$ settles to 0.1%	MAX4251/MAX4253		8		$\mu s$
			MAX4249/MAX4256		3.5		
Power-Up Delay Time	$t_{PU}$	$V_{DD} = 0$ to $5V$ step, $V_{OUT}$ stable to 0.1%			6		$\mu s$

**Note 2:**  $\overline{SHDN}$  is available on the MAX4249/MAX4251/MAX4253/MAX4256 only.

**Note 3:** All device specifications are 100% tested at  $T_A = +25^\circ C$ . Limits over temperature are guaranteed by design.

**Note 4:** Guaranteed by the PSRR test.

**Note 5:** Offset voltage prior to reflow on the UCSP.

**Note 6:** Guaranteed by design.

**Note 7:** Lowpass-filter bandwidth is 22kHz for  $f = 1kHz$  and 80kHz for  $f = 20kHz$ . Noise floor of test equipment =  $10nV/\sqrt{Hz}$ .

Typical Operating Characteristics

( $V_{DD} = 5V$ ,  $V_{SS} = 0V$ ,  $V_{CM} = V_{OUT} = V_{DD}/2$ , input noise floor of test equipment =  $10nV/\sqrt{Hz}$  for all distortion measurements,  $T_A = +25^\circ C$ , unless otherwise noted.)

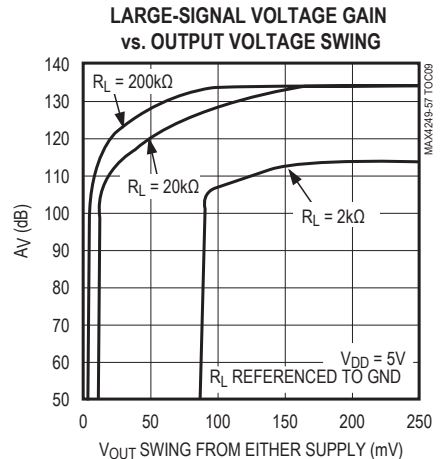
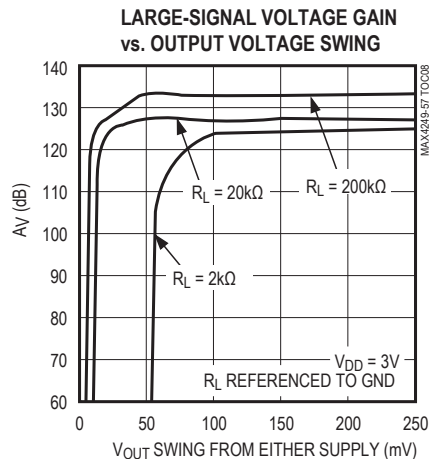
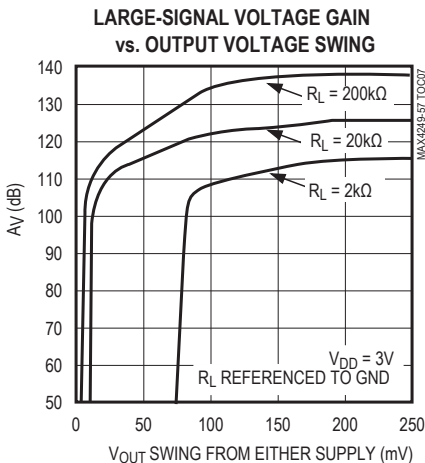
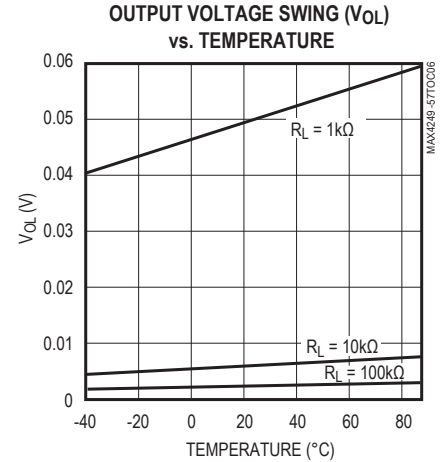
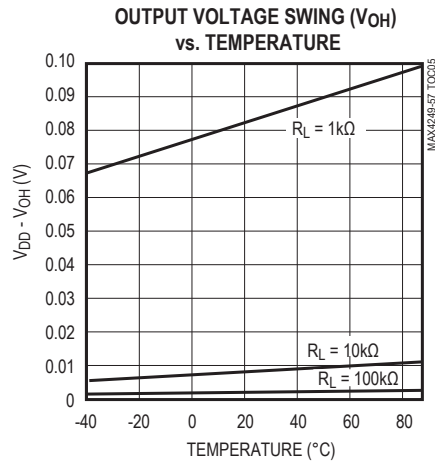
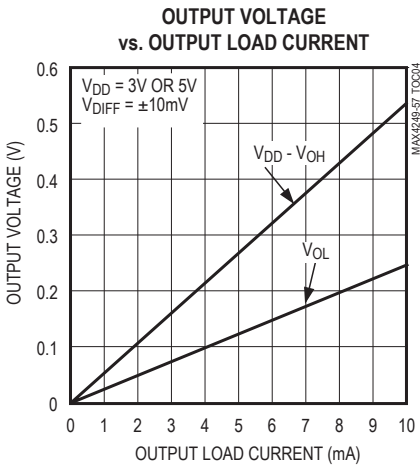
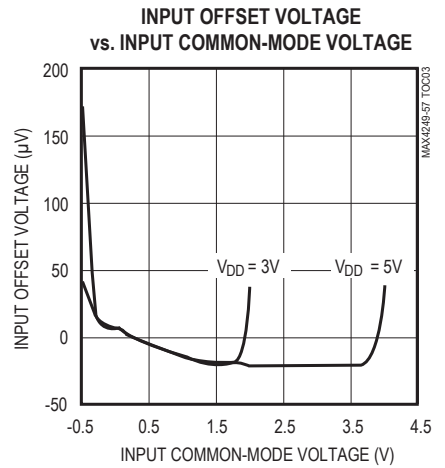
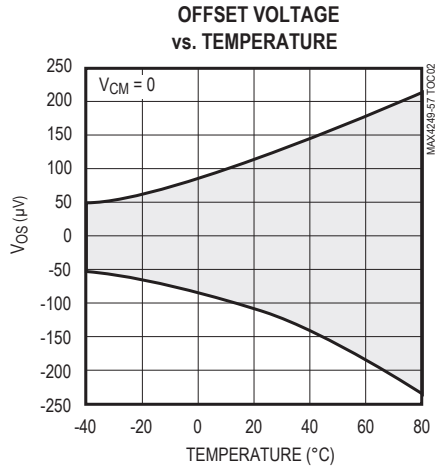
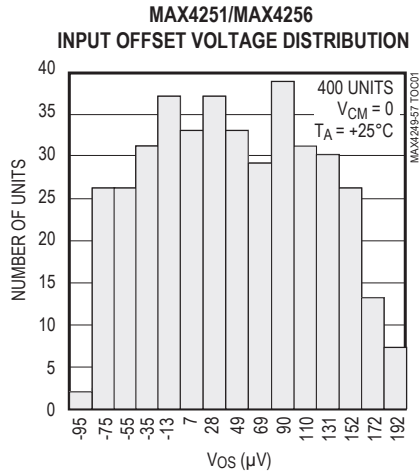

Typical Operating Characteristics (continued)

( $V_{DD} = 5V$ ,  $V_{SS} = 0V$ ,  $V_{CM} = V_{OUT} = V_{DD}/2$ , input noise floor of test equipment =  $10nV/\sqrt{Hz}$  for all distortion measurements,  $T_A = +25^\circ C$ , unless otherwise noted.)

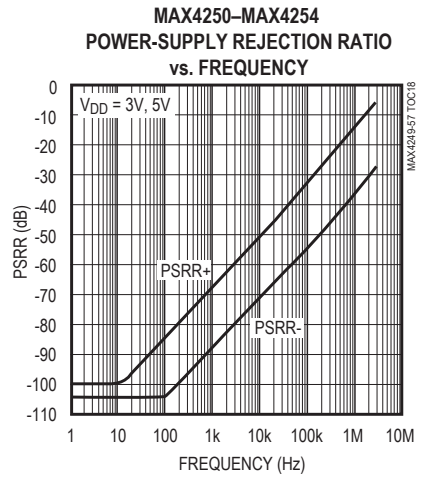
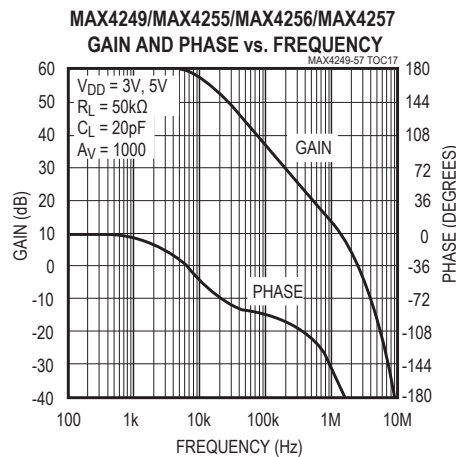
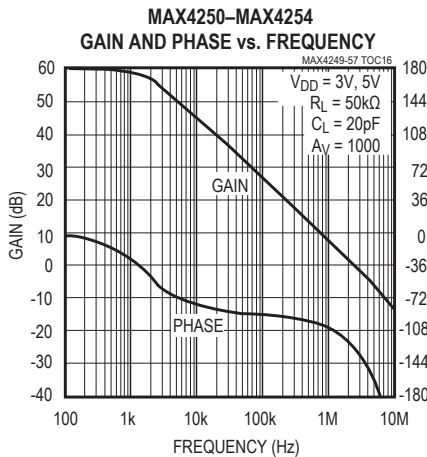
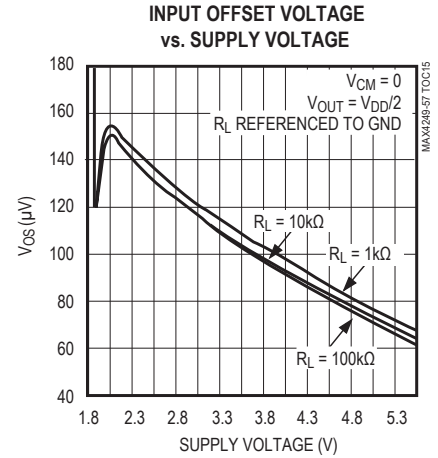
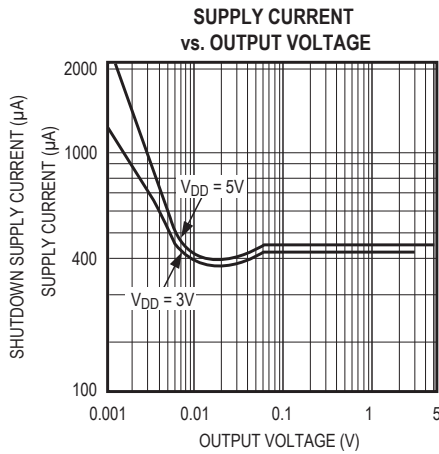
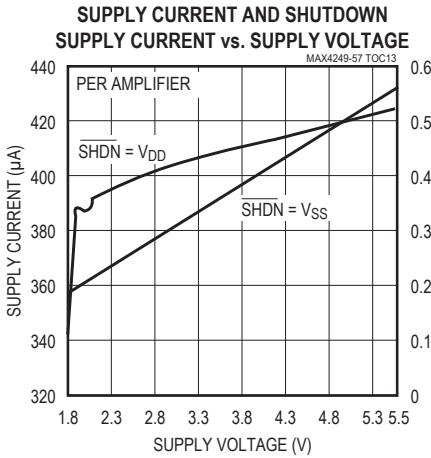
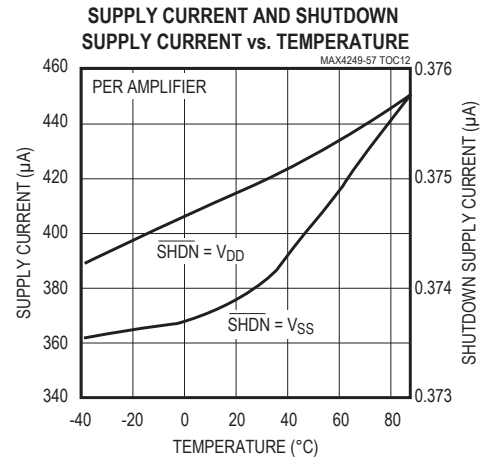
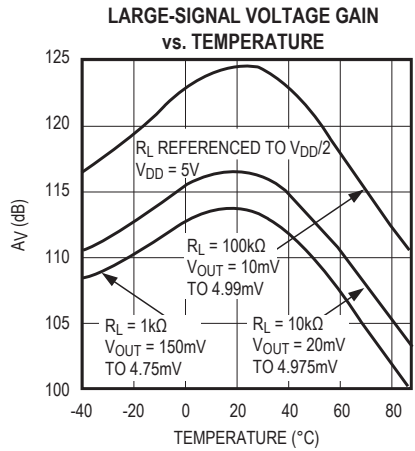
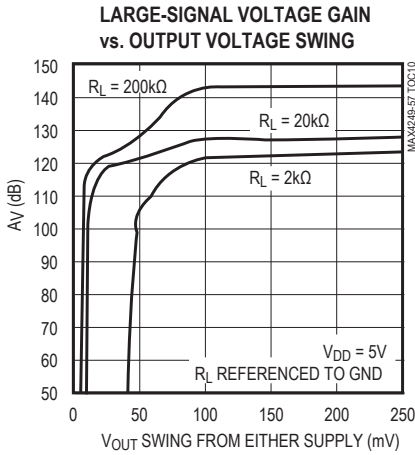

Typical Operating Characteristics (continued)

( $V_{DD} = 5V$ ,  $V_{SS} = 0V$ ,  $V_{CM} = V_{OUT} = V_{DD}/2$ , input noise floor of test equipment =  $10nV/\sqrt{Hz}$  for all distortion measurements,  $T_A = +25^\circ C$ , unless otherwise noted.)

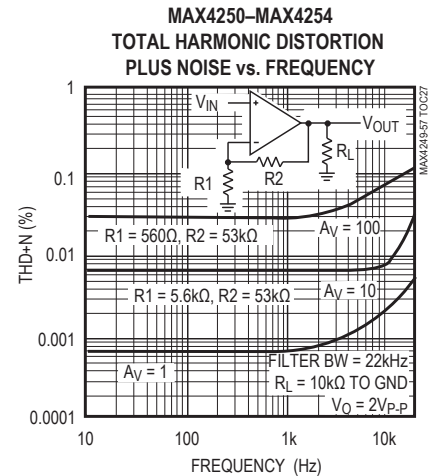
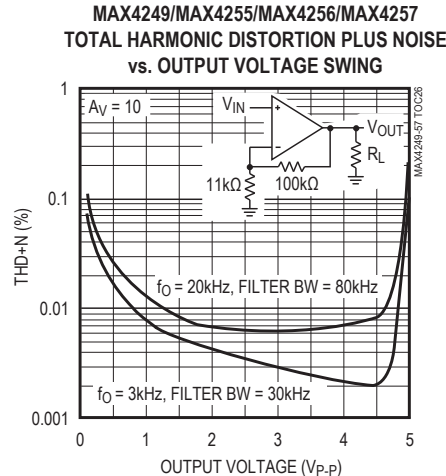
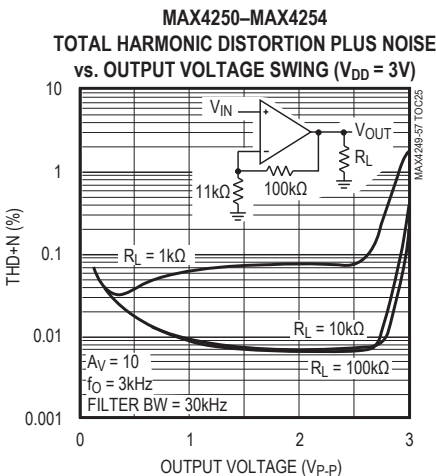
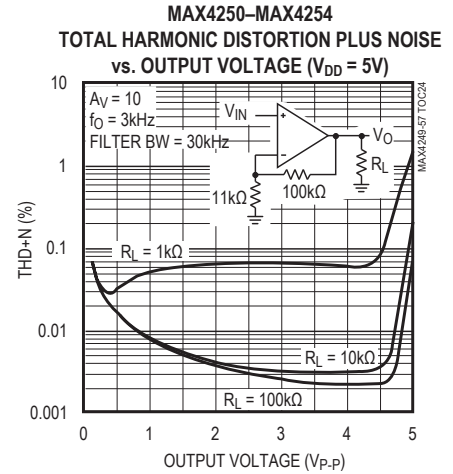
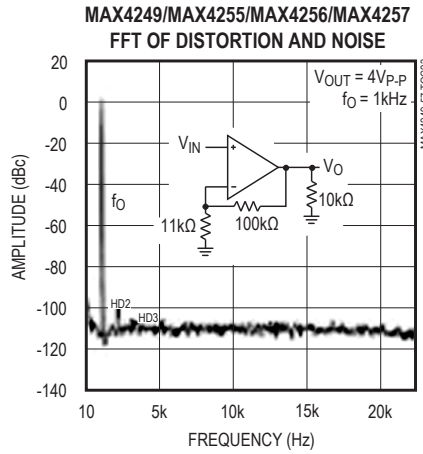
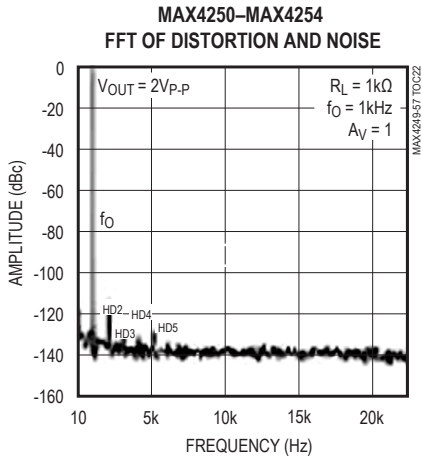
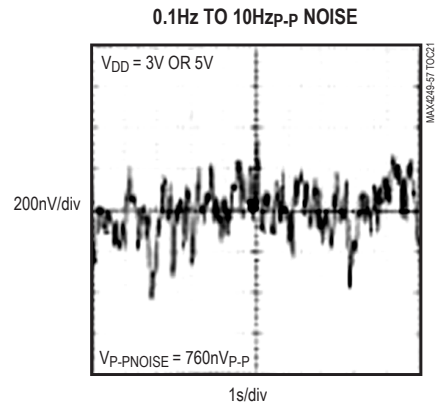
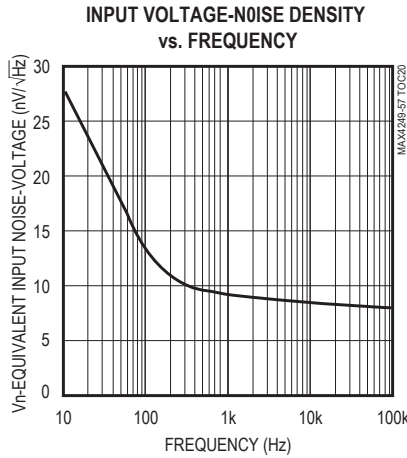
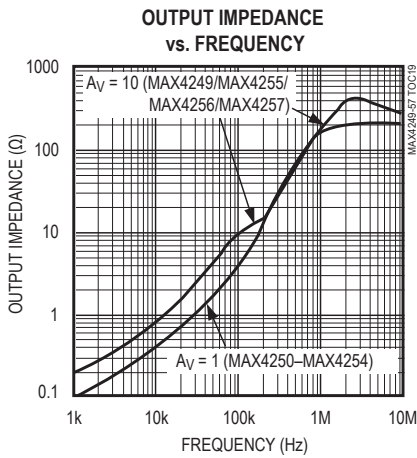

Typical Operating Characteristics (continued)

( $V_{DD} = 5V$ ,  $V_{SS} = 0V$ ,  $V_{CM} = V_{OUT} = V_{DD}/2$ , input noise floor of test equipment =  $10nV/\sqrt{Hz}$  for all distortion measurements,  $T_A = +25^\circ C$ , unless otherwise noted.)

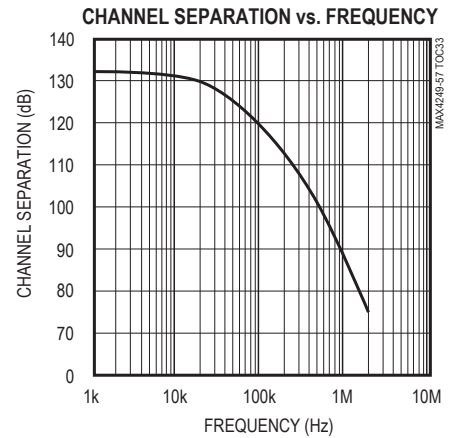
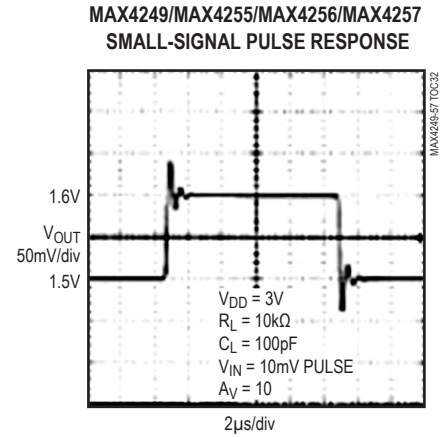
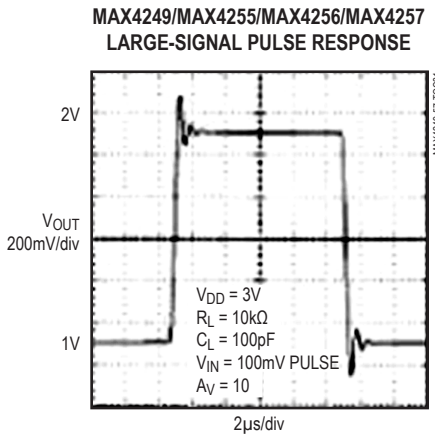
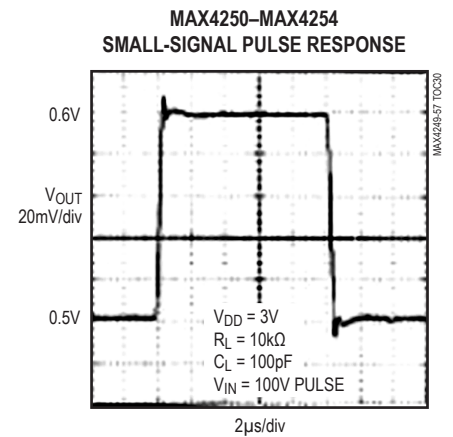
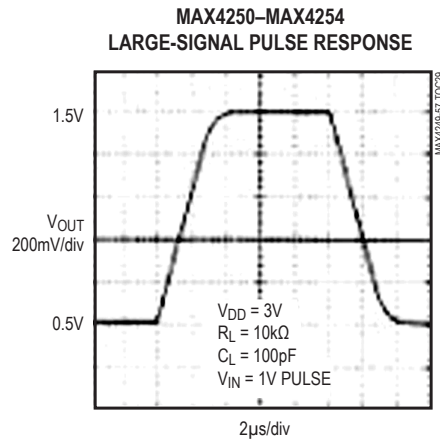
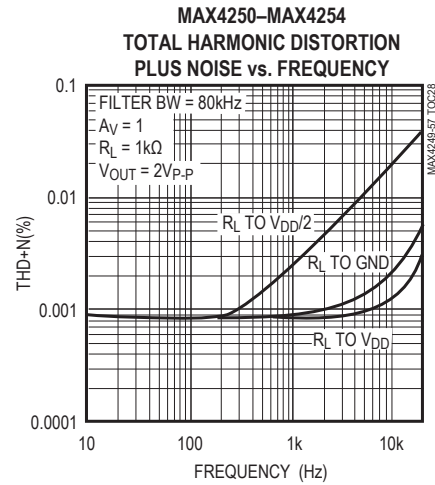

Pin/Bump Description

PIN/BUMP								NAME	FUNCTION
MAX4250/ MAX4255	MAX4251/ MAX4256	MAX4252/ MAX4257	MAX4252	MAX4249/ MAX4253			MAX4254		
5-PIN SOT23	8-PIN SO/ $\mu$ MAX	8-PIN SO/ $\mu$ MAX	8-BUMP UCSP	10-BUMP UCSP	10-PIN $\mu$ MAX	14-PIN SO	14-PIN SO		
1	6	1, 7	A1, A3	A1, C1	1, 9	1, 13	1, 7, 8, 14	OUT, OUTA, OUTB, OUTC, OUTD	Amplifier Output
2	4	4	C2	B4	4	4	11	V <sub>SS</sub>	Negative Supply. Connect to ground for single-supply operation
3	3	3, 5	C1, C3	A3, C3	3, 7	3, 11	3, 5, 10, 12	IN+, INA+, INB+, INC+, IND+	Noninverting Amplifier Input
4	2	2, 6	B1, B3	A2, C2	2, 8	2, 12	2, 6, 9, 13	IN-, INA-, INB-, INC-, IND-	Inverting Amplifier Input
5	7	8	A2	B1	10	14	4	V <sub>DD</sub>	Positive Supply
—	8	—	—	A4, C4	5, 6	6, 9	—	$\overline{\text{SHDN}}$ , SHDNA, SHDNB	Shutdown Input, Connect to V <sub>DD</sub> or leave unconnected for normal operation (amplifier(s) enabled).
—	1, 5	—	—	—	—	5, 7, 8, 10	—	N.C.	No Connection. Not internally connected.
—	—	—	B2	B2, B3	—	—	—	—	Not populated with solder sphere

Detailed Description

The MAX4249–MAX4257 single-supply operational amplifiers feature ultra-low noise and distortion while consuming very little power. Their low distortion and low noise make them ideal for use as preamplifiers in wide dynamic-range applications, such as 16-bit analog-to-digital converters (see *Typical Operating Circuit*). Their high-input impedance and low noise are also useful for signal conditioning of high-impedance sources, such as piezoelectric transducers.

These devices have true rail-to-rail output operation, drive loads as low as 1k $\Omega$  while maintaining DC accuracy, and can drive capacitive loads up to 400pF without oscillation.

The input common-mode voltage range extends from V<sub>DD</sub> - 1.1V to 200mV beyond the negative rail. The push-pull output stage maintains excellent DC characteristics, while delivering up to  $\pm 5$ mA of current.

The MAX4250–4254 are unity-gain stable, whereas, the MAX4249/MAX4255/MAX4256/MAX4257 have a higher slew rate and are stable for gains  $\geq 10$ V/V. The MAX4249/MAX4251/MAX4253/MAX4256 feature a low-power shutdown mode, which reduces the supply current to 0.5 $\mu$ A and disables the outputs.

The MAX4250AAUK is specified for operation over the automotive (-40°C to +125°C) temperature range.

**Low Distortion**

Many factors can affect the noise and distortion that the device contributes to the input signal. The following guidelines offer valuable information on the impact of design choices on Total Harmonic Distortion (THD).

Choosing proper feedback and gain resistor values for a particular application can be a very important factor in reducing THD. In general, the smaller the closed-loop gain, the smaller the THD generated, especially when driving heavy resistive loads. Large-value feedback resistors can significantly improve distortion. The THD of the part normally increases at approximately 20dB per decade, as a function of frequency. Operating the device near or above the full-power bandwidth significantly degrades distortion.

Referencing the load to either supply also improves the part's distortion performance, because only one of the MOSFETs of the push-pull output stage drives the output. Referencing the load to midsupply increases the part's distortion for a given load and feedback setting. (See the Total Harmonic Distortion vs. Frequency graph in the *Typical Operating Characteristics*.)

For gains  $\geq 10V/V$ , the decompensated devices MAX4249/MAX4255/MAX4256/MAX4257 deliver the best distortion performance, since they have a higher slew rate and provide a higher amount of loop gain for a given closed-loop gain setting. Capacitive loads below 400pF, do not significantly affect distortion results. Distortion performance remains relatively constant over supply voltages.

**Low Noise**

The amplifier's input-referred, noise-voltage density is dominated by flicker noise at lower frequencies, and by thermal noise at higher frequencies. Because the thermal noise contribution is affected by the parallel combination of the feedback resistive network ( $R_F \parallel R_G$ , Figure 1), these resistors should be reduced in cases where the system bandwidth is large and thermal noise is dominant. This noise contribution factor decreases, however, with increasing gain settings.

For example, the input noise-voltage density of the circuit with  $R_F = 100k\Omega$ ,  $R_G = 11k\Omega$  ( $A_V = 10V/V$ ) is  $e_n = 15nV/\sqrt{Hz}$ ,  $e_n$  can be reduced to  $9nV/\sqrt{Hz}$  by choosing  $R_F = 10k\Omega$ ,  $R_G = 1.1k\Omega$  ( $A_V = 10V/V$ ), at the expense of greater current consumption and potentially higher distortion. For a gain of  $100V/V$  with  $R_F = 100k\Omega$ ,  $R_G = 1.1k\Omega$ , the  $e_n$  is low ( $9nV/\sqrt{Hz}$ ).

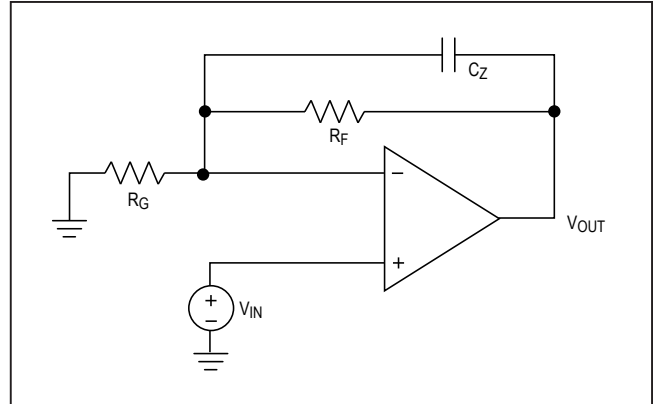

Figure 1. Adding Feed-Forward Compensation

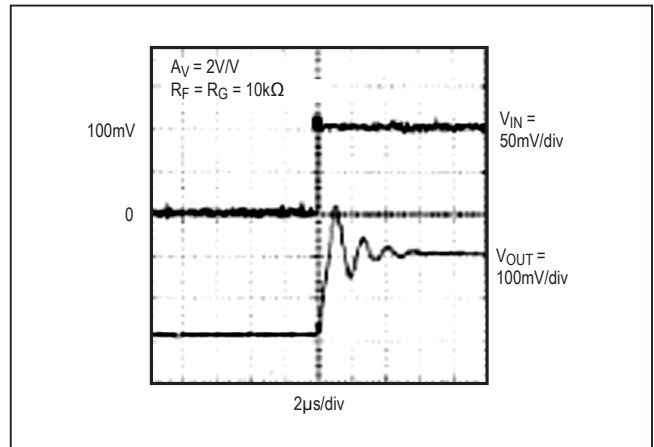

Figure 2a. Pulse Response with No Feed-Forward Compensation

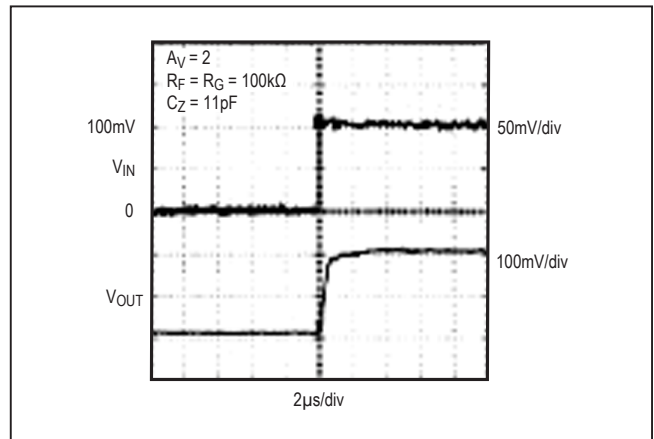

Figure 2b. Pulse Response with 10pF Feed-Forward Compensation

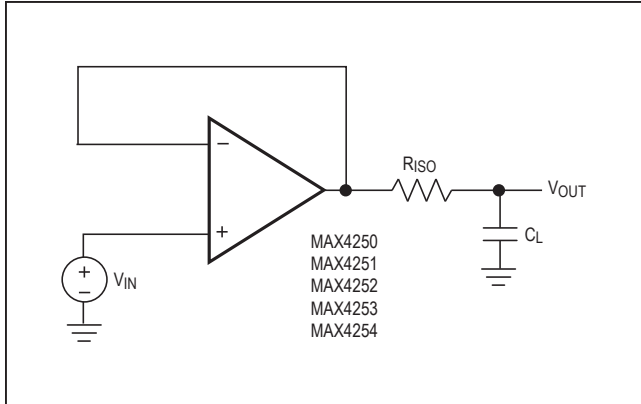

Figure 3. Overdriven Input Showing No Phase Reversal

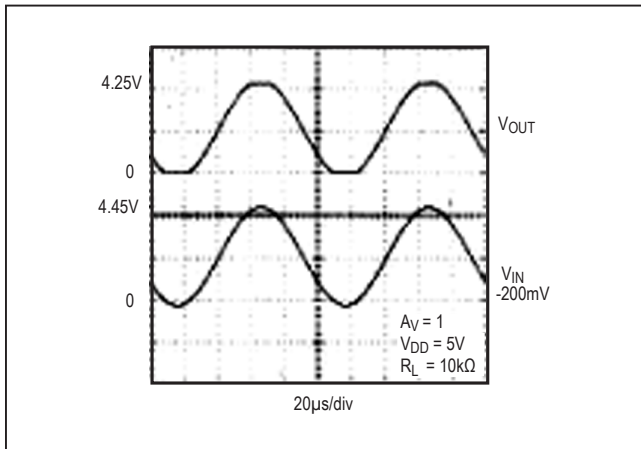

Figure 4. Rail-to-Rail Output Operation

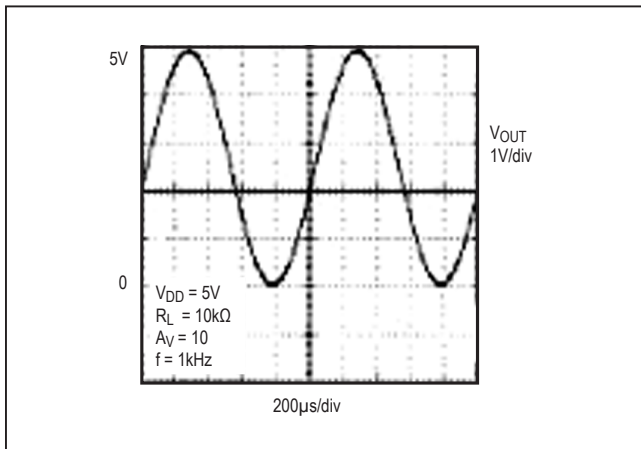

Figure 5. Capacitive-Load Driving Circuit

### Using a Feed-Forward Compensation Capacitor, $C_Z$

The amplifier's input capacitance is 11pF. If the resistance seen by the inverting input is large (feedback network), this can introduce a pole within the amplifier's bandwidth, resulting in reduced phase margin. Compensate the reduced phase margin by introducing a feed-forward capacitor ( $C_Z$ ) between the inverting input and the output (Figure 1). This effectively cancels the pole from the inverting input of the amplifier. Choose the value of  $C_Z$  as follows:

$$C_Z = 11 \times (R_F / R_G) \text{ [pF]}$$

In the unity-gain stable MAX4250–MAX4254, the use of a proper  $C_Z$  is most important for  $A_V = 2V/V$ , and  $A_V = -1V/V$ . In the decompensated MAX4249/MAX4255/MAX4256/MAX4257,  $C_Z$  is most important for  $A_V = 10V/V$ . Figures 2a and 2b show transient response both with and without  $C_Z$ .

Using a slightly smaller  $C_Z$  than suggested by the formula above achieves a higher bandwidth at the expense of reduced phase and gain margin. As a general guideline, consider using  $C_Z$  for cases where  $R_G \parallel R_F$  is greater than 20kΩ (MAX4250–MAX4254) or greater than 5kΩ (MAX4249/MAX4255/MAX4256/MAX4257).

### Applications Information

The MAX4249–MAX4257 combine good driving capability with ground-sensing input and rail-to-rail output operation. With their low distortion, low noise, and lowpower consumption, these devices are ideal for use in portable instrumentation systems and other low-power, noise-sensitive applications.

### Ground-Sensing and Rail-to-Rail Outputs

The common-mode input range of these devices extends below ground, and offers excellent commonmode rejection. These devices are guaranteed not to undergo phase reversal when the input is overdriven (Figure 3).

Figure 4 showcases the true rail-to-rail output operation of the amplifier, configured with  $A_V = 10V/V$ . The output swings to within 8mV of the supplies with a 10kΩ load, making the devices ideal in low-supply-voltage applications.

### Output Loading and Stability

Even with their low quiescent current of 400µA, these amplifiers can drive 1kΩ loads while maintaining excellent DC accuracy. Stability while driving heavy capacitive loads is another key feature.

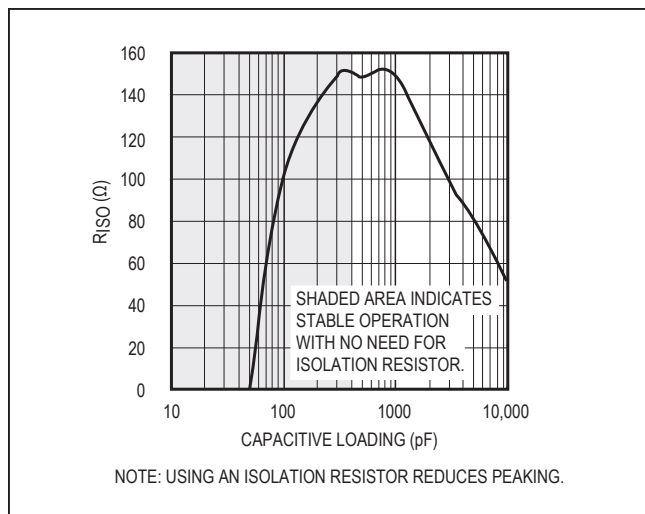

Figure 6. Isolation Resistance vs. Capacitive Loading to Minimize Peaking (<2dB)

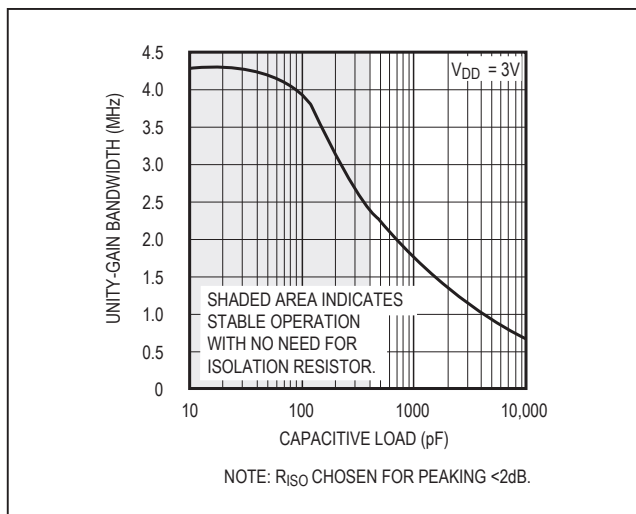

Figure 8. MAX4250–MAX4254 Unity-Gain Bandwidth vs. Capacitive Load

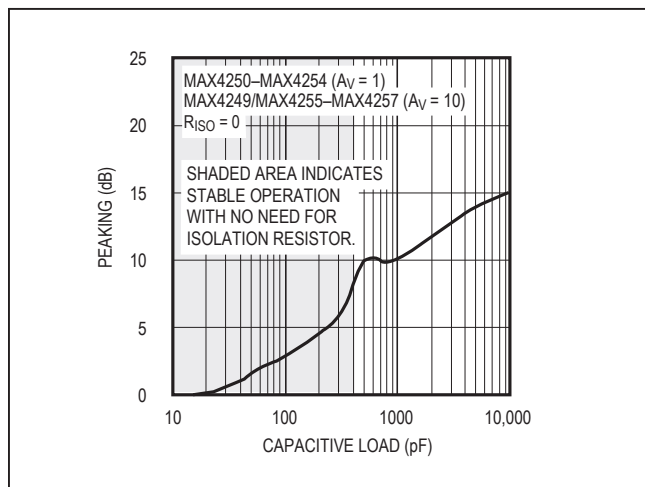

Figure 7. Peaking vs. Capacitive Load

These devices maintain stability while driving loads up to 400pF. To drive higher capacitive loads, place a small isolation resistor in series between the output of the amplifier and the capacitive load (Figure 5). This resistor improves the amplifier’s phase margin by isolating the capacitor from the op amp’s output. Reference Figure 6 to select a resistance value that will ensure a load capacitance that limits peaking to <2dB (25%). For example, if the capacitive load is 1000pF, the corresponding isolation resistor is 150Ω. Figure 7 shows that peaking occurs without the isolation resistor. Figure 8 shows the unity-gain bandwidth vs. capacitive load for the MAX4250–MAX4254.

**Power Supplies and Layout**

The MAX4249–MAX4257 operate from a single 2.4V to 5.5V power supply or from dual supplies of ±1.20V to ±2.75V. For single-supply operation, bypass the power supply with a 0.1μF ceramic capacitor placed close to the V<sub>DD</sub> pin. If operating from dual supplies, bypass each supply to ground.

Good layout improves performance by decreasing the amount of stray capacitance and noise at the op amp’s inputs and output. To decrease stray capacitance, minimize PC board trace lengths and resistor leads, and place external components close to the op amp’s pins.

Typical Operating Circuit

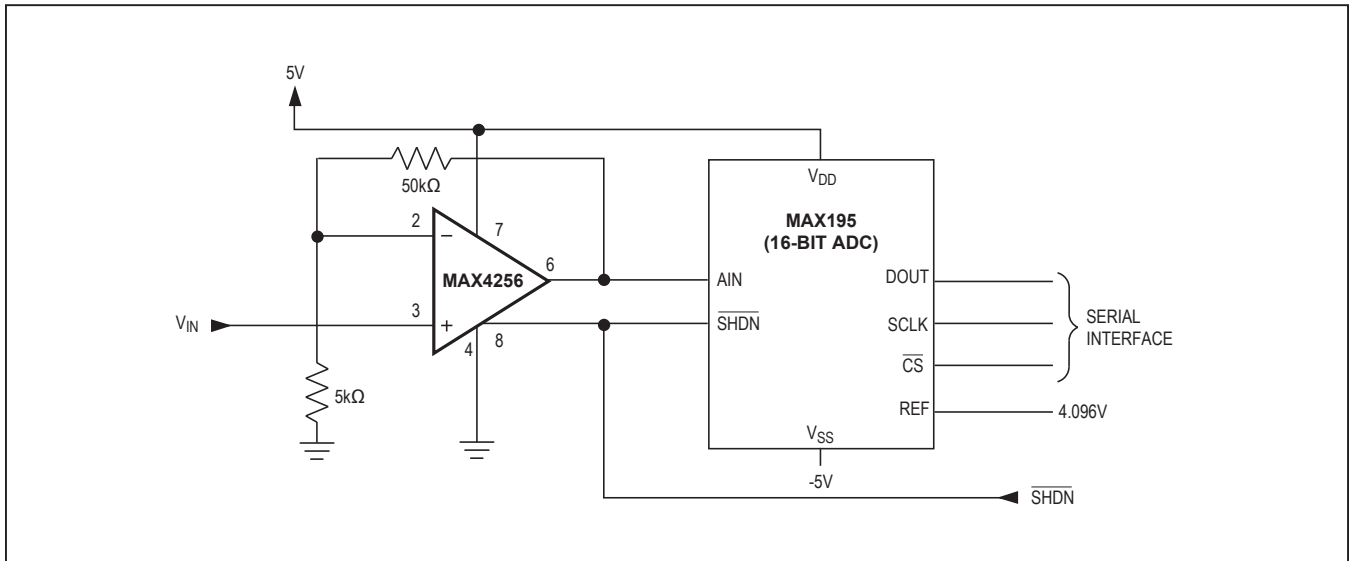

Selector Guide

PART	GAIN BANDWIDTH (MHz)	MINIMUM STABLE GAIN (V/V)	NO. OF AMPLIFIERS PER PACKAGE	SHUTDOWN MODE	PIN-PACKAGE
MAX4249	22	10	2	Yes	10-pin $\mu$ MAX, 14-pin SO
MAX4250/A	3	1	1	—	5-pin SOT23
MAX4251	3	1	1	Yes	8-pin $\mu$ MAX/SO
MAX4252	3	1	2	—	8-pin $\mu$ MAX/SO, 8-bump UCSP
MAX4253	3	1	2	Yes	10-pin $\mu$ MAX, 14-pin SO, 10-bump UCSP
MAX4254	3	1	4	—	14-pin SO
MAX4255	22	10	1	—	5-pin SOT23
MAX4256	22	10	1	Yes	8-pin $\mu$ MAX/SO
MAX4257	22	10	2	—	8-pin $\mu$ MAX/SO

**Pin/Bump Configurations (continued)**

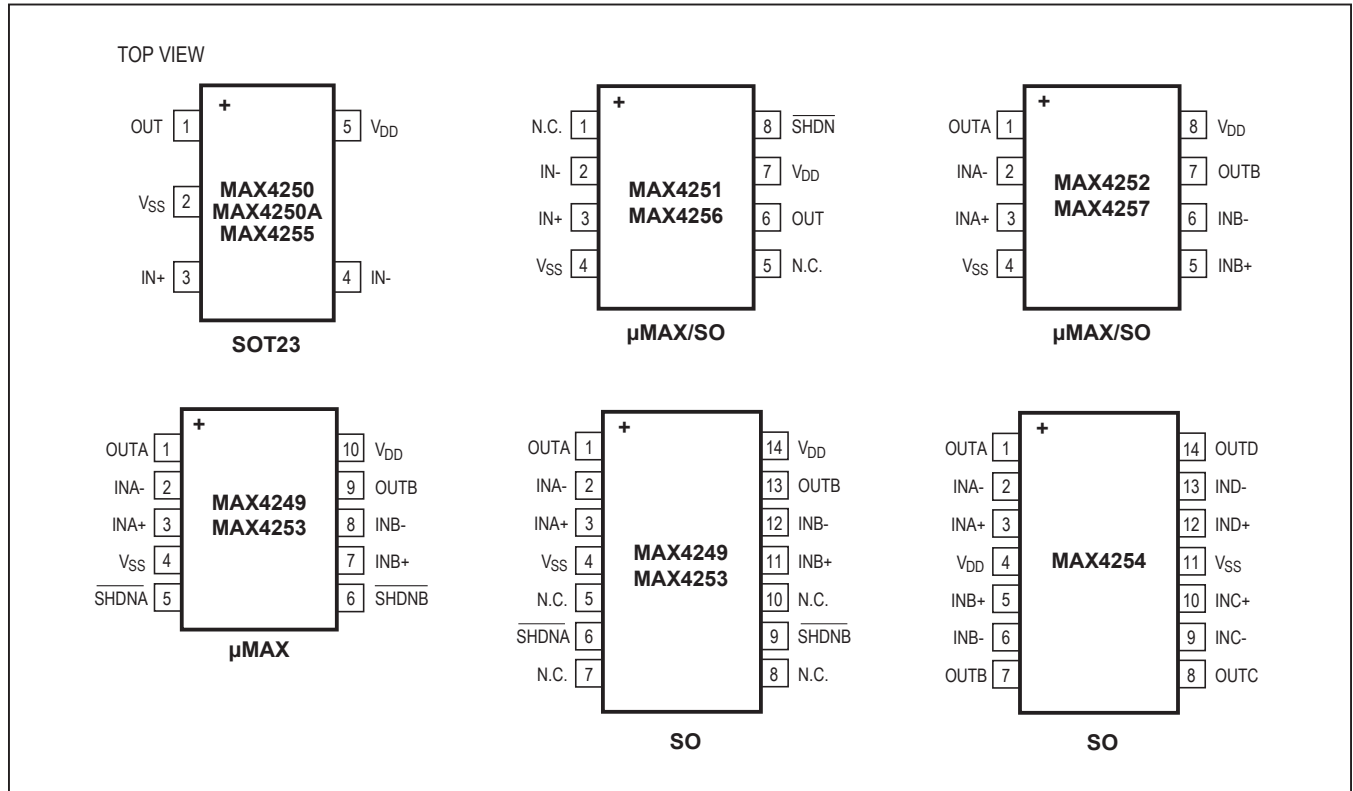

**Ordering Information (continued)**

PART	TEMP RANGE	PIN-PACKAGE	TOP MARK
MAX4251ESA+	-40°C to +85°C	8 SO	—
MAX4251EUA+	-40°C to +85°C	8 μMAX	—
MAX4252EBL+T	-40°C to +85°C	8 UCSP	AAO
MAX4252ESA+	-40°C to +85°C	8 SO	—
MAX4252EUA+	-40°C to +85°C	8 μMAX	—
MAX4253EBC+T	-40°C to +85°C	10 UCSP	AAK
MAX4253EUB+	-40°C to +85°C	10 μMAX	—
MAX4253ESD+	-40°C to +85°C	14 SO	—
MAX4254ESD+	-40°C to +85°C	14 SO	—
MAX4255EUK+T	-40°C to +85°C	5 SOT23	ACCJ
MAX4256ESA+	-40°C to +85°C	8 SO	—
MAX4256EUA+	-40°C to +85°C	8 μMAX	—
MAX4257ESA+	-40°C to +85°C	8 SO	—
MAX4257ESA/V+T	-40°C to +85°C	8 SO	—
MAX4257EUA+	-40°C to +85°C	8 μMAX	—

**Package Information**

For the latest package outline information and land patterns (footprints), go to [www.maximintegrated.com/packages](http://www.maximintegrated.com/packages). Note that a "+", "#", or "-" in the package code indicates RoHS status only. Package drawings may show a different suffix character, but the drawing pertains to the package regardless of RoHS status.

PACKAGE TYPE	PACKAGE CODE	OUTLINE NO.	LAND PATTERN NO.
5 SOT-23	U5+2	<a href="#">21-0057</a>	<a href="#">90-0174</a>
8 $\mu$ MAX	U8+1	<a href="#">21-0036</a>	<a href="#">90-0092</a>
10 $\mu$ MAX	U10+2	<a href="#">21-0061</a>	<a href="#">90-0330</a>
3 x 3 $\mu$ CSP	B9+5	<a href="#">21-0093</a>	—
14 SOIC	S14+1	<a href="#">21-0041</a>	<a href="#">90-0112</a>
12 $\mu$ CSP	B12+4	<a href="#">21-0104</a>	—

Revision History

REVISION NUMBER	REVISION DATE	DESCRIPTION	PAGES CHANGED
8	10/11	Added lead-free packaging to the Ordering Information and changed the Input Bias Current and Input Offset Current conditions in the <i>Electrical Characteristics</i> table	1, 2, 14
9	12/12	Added MAX4257ESA/V+T to <i>Ordering Information</i> .	14
10	4/20	Updated <i>Electrical Characteristics</i> table	3



Information furnished by Analog Devices is believed to be accurate and reliable. However, no responsibility is assumed by Analog Devices for its use, nor for any infringements of patents or other rights of third parties that may result from its use. Specifications subject to change without notice. No license is granted by implication or otherwise under any patent or patent rights of Analog Devices. Trademarks and registered trademarks are the property of their respective owners.

## Looking for pricing, stock, or lifecycle information?

Click below to explore more details on WIN SOURCE:

 [View MAX4252ESA-T on WIN SOURCE](#)

 [Maxim Integrated](#) Information

## Optimize Your Supply Chain with WIN SOURCE Solutions

-  Global Sourcing Solution
-  Obsolete Management
-  Cost Control Management
-  Shortage Management
-  Alternative Solution
-  Excess Inventory Management