



**THE DATASHEET OF  
MBR2020CTF-G1**



## Product Summary

$V_{RRM}$ (V)	$I_O$ (A)	$V_F$ (MAX) (V) @ +25°C	$I_R$ (MAX) (mA) @ +25°C
200	2 × 10	0.90	0.05

## Description

High voltage dual Schottky rectifier suited for switch mode power supplies and other power converters. This device is intended for use in medium voltage operation, and particularly, in high frequency circuits where low switching losses and low noise are required.

The MBR20200C is available in TO-220-3 (2) and TO-220F-3 packages.

## Applications

- Power Supply Output Rectification
- Power Management
- Instrumentation

## Features

- Low Forward Voltage: 0.9V @ +25°C
- High Surge Capacity
- +150°C Operating Junction Temperature
- 20A Total (10A Per Diode Leg)
- Guard-Ring for Stress Protection
- **Lead-Free Finish; RoHS Compliant (Notes 1 & 2)**
- **Halogen and Antimony Free. "Green" Device (Note 3)**
- **For automotive applications requiring specific change control (i.e. parts qualified to AEC-Q101, PPAP capable, and manufactured in IATF 16949 certified facilities), please [contact us](mailto:contact@diodes.com) or your local Diodes representative.**
- <https://www.diodes.com/quality/product-definitions/>

## Mechanical Data

- Case: TO-220-3 (2), TO-220F-3
- Case Material: Molded Plastic, "Green" Molding Compound. UL Flammability Classification Rating 94V-0
- Moisture Sensitivity: Level 1 per J-STD-020
- Terminals: Finish - Matte Tin Annealed over Copper Leadframe. Solderable per MIL-STD-202, Method 208 (E3)
- Polarity: See Below
- Weight:
  - TO-220-3 (2) – 1.95 Grams (Approximate)
  - TO-220F-3 – 1.69 Grams (Approximate)

**TO-220F-3**

**TO-220-3 (2)**

- Notes:
1. EU Directive 2002/95/EC (RoHS), 2011/65/EU (RoHS 2) & 2015/863/EU (RoHS 3) compliant. All applicable RoHS exemptions applied.
  2. See <https://www.diodes.com/quality/lead-free/> for more information about Diodes Incorporated's definitions of Halogen- and Antimony-free, "Green" and Lead-free.
  3. Halogen- and Antimony-free "Green" products are defined as those which contain <900ppm bromine, <900ppm chlorine (<1500ppm total Br + Cl) and <1000ppm antimony compounds.

## Pin Assignments

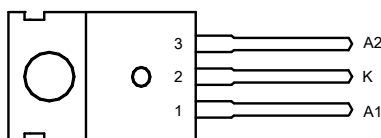
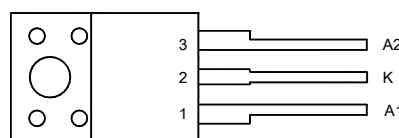
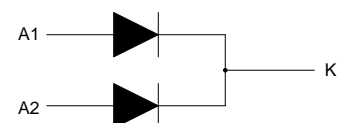
**(Front View)**

**TO-220-3 (2)**
**(Front View)**

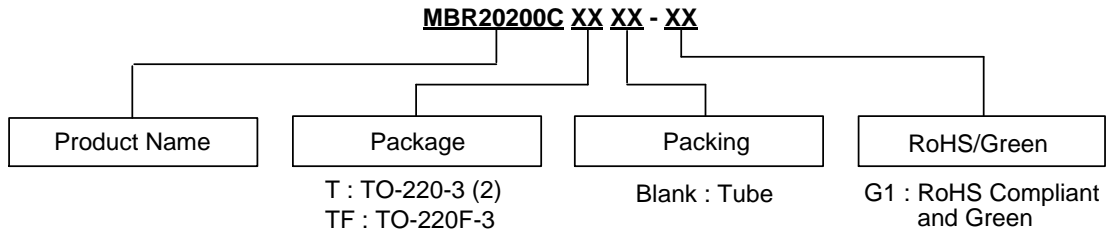
**TO-220F-3**

**Internal Structure of MBR20200C**

**Ordering Information** (Note 4)



Package	Part Number	Marking ID	Packing
TO-220-3 (2)	MBR20200CT-G1	MBR20200CT-G1	50 Pieces/Tube
TO-220F-3	MBR20200CTF-G1	MBR20200CTF-G1	50 Pieces/Tube

Note: 4. For packaging details, go to our website at <https://www.diodes.com/design/support/packaging/diodes-packaging/>.

**Marking Information**

(1) TO-220-3 (2)

(Front View)

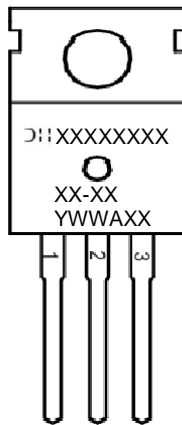

First and Second Lines: Logo and Marking ID  
(See Ordering Information)  
Third Line: Date Code  
Y: Year  
WW: Work Week of Molding  
A: Assembly House Code  
XX: 7th and 8th Digits of Batch Number

**Marking Information** (continued)

(2) TO-220F-3

(Front View)

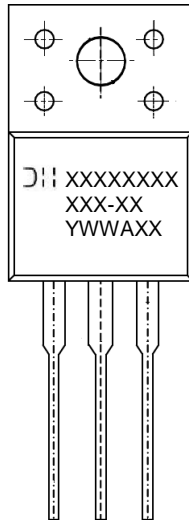

First and Second Lines: Logo and Marking ID  
 (See Ordering Information)  
 Third Line: Date Code  
 Y: Year  
 WW: Work Week of Molding  
 A: Assembly House Code  
 XX: 7th and 8th Digits of Batch Number

**Maximum Ratings** (Each Diode Leg)

Characteristic	Symbol	Rating	Unit
Peak Repetitive Reverse Voltage	$V_{RRM}$	200	V
Working Peak Reverse Voltage	$V_{RWM}$		
DC Blocking Voltage	$V_R$		
Average Rectified Forward Current (Rated $V_R$ ) $T_C = +133^\circ\text{C}$	$I_{F(AV)}$	10	A
Peak Repetitive Forward Current (Rated $V_R$ , Square Wave, 20kHz) $T_C = +130^\circ\text{C}$	$I_{FRM}$	20	A
Non Repetitive Peak Surge Current (Surge Applied at Rated Load Conditions Half Wave, Single Phase, 60Hz)	$I_{FSM}$	150	A
Operating Junction Temperature Range (Note 5)	$T_J$	+150	$^\circ\text{C}$
Storage Temperature Range	$T_{STG}$	-65 to +150	$^\circ\text{C}$
Voltage Rate of Change (Rated $V_R$ )	$dv/dt$	10000	V/ $\mu\text{s}$
ESD (Machine Model = C)	—	>400	V
ESD (Human Body Model = 3B)	—	>8000	V

Note: 5. The heat generated must be less than the thermal conductivity from Junction to Ambient:  $dP_D/dT_J < 1/\theta_{JA}$ .

## Thermal Characteristics

Characteristic	Symbol	Rating		Unit
Maximum Thermal Resistance (Junction to Case) (Note 6)	$R_{\theta JC}$	TO-220-3 (2)	2.0	°C/W
		TO-220F-3	2.5	
Maximum Thermal Resistance (Junction to Ambient) (Note 6)	$R_{\theta JA}$	TO-220-3 (2)	60	
		TO-220F-3	60	

Note: 6. Device mounted on heat sink, with minimum recommended pad layout per <http://www.diodes.com/package-outlines.html>.

## Electrical Characteristics

Characteristic	Symbol	Rating	Unit	Test Condition
Maximum Instantaneous Forward Voltage Drop (Note 7)	$V_F$	0.9	V	$I_F = 10A, T_C = +25^\circ C$
Maximum Instantaneous Reverse Current (Note 7)	$I_R$	6.0	mA	Rated DC Voltage, $T_C = +125^\circ C$
		0.05		Rated DC Voltage, $T_C = +25^\circ C$

Note: 7. Short duration pulse test used to minimize self-heating effect, Pulse Test Width = 300µs, Duty Cycle < 2.0%.

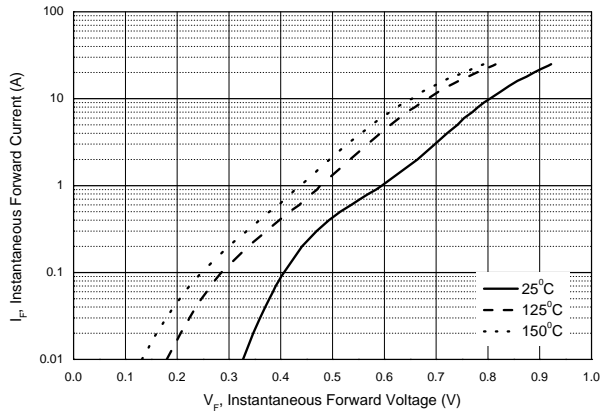

Figure 1. Typical Forward Voltage Per Diode

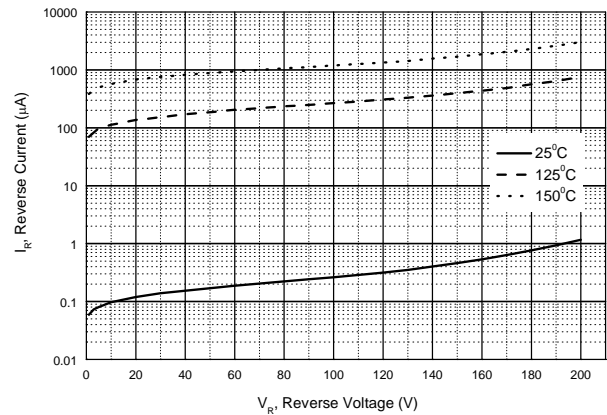

Figure 2. Typical Reverse Current Per Diode

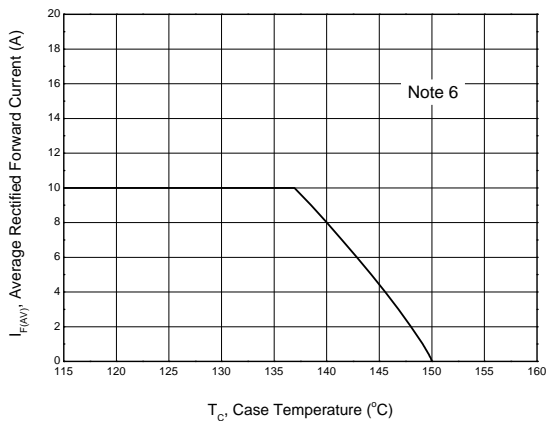
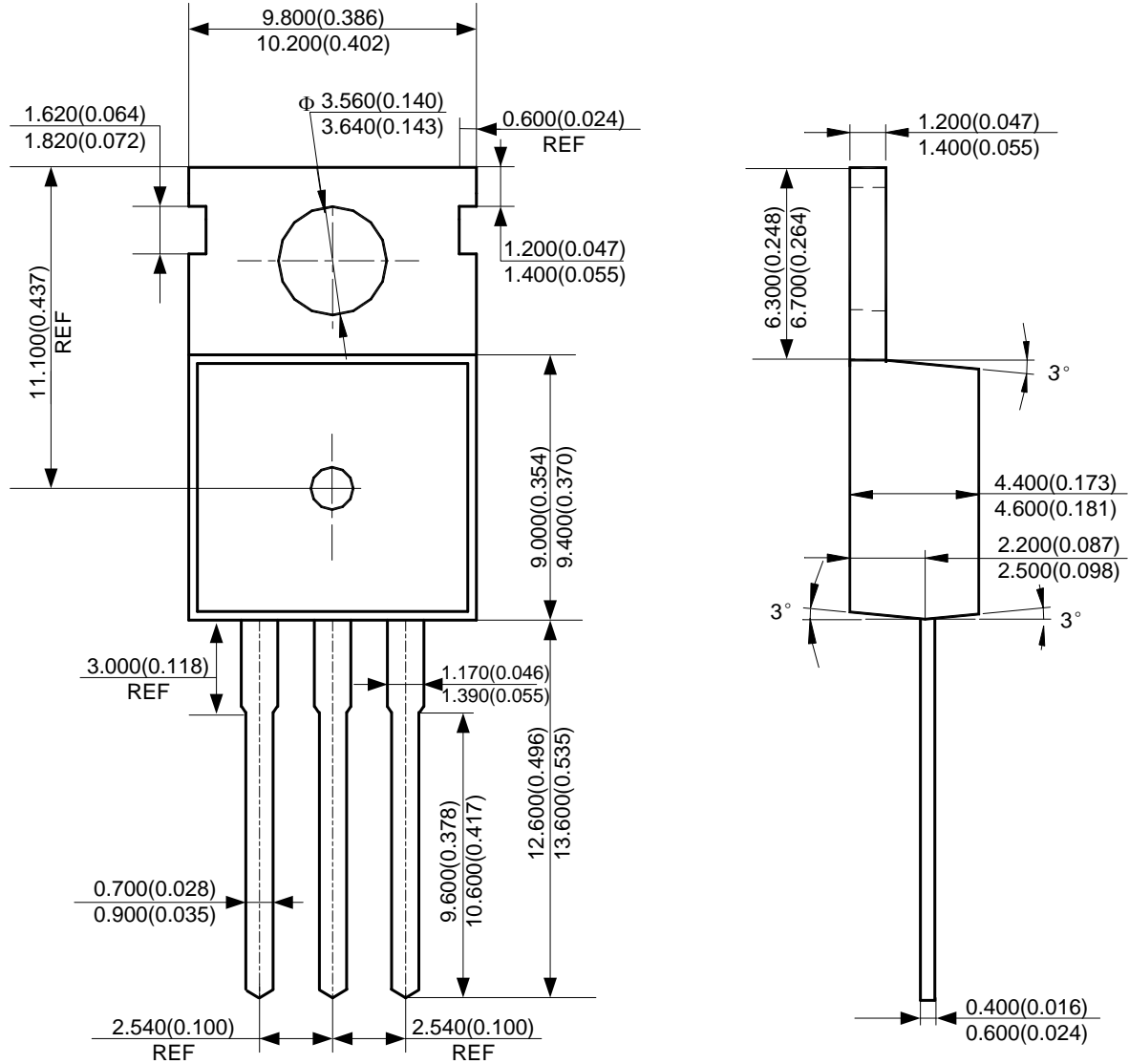

Figure 3. Average Rectified Forward Current vs. Case Temperature (Per Diode)

**Package Outline Dimensions** (All dimensions in mm(inch).)

(1) Package Type: TO-220-3 (2)



**Package Outline Dimensions** (continued) (All dimensions in mm(inch).)

(2) Package Type: TO-220F-3

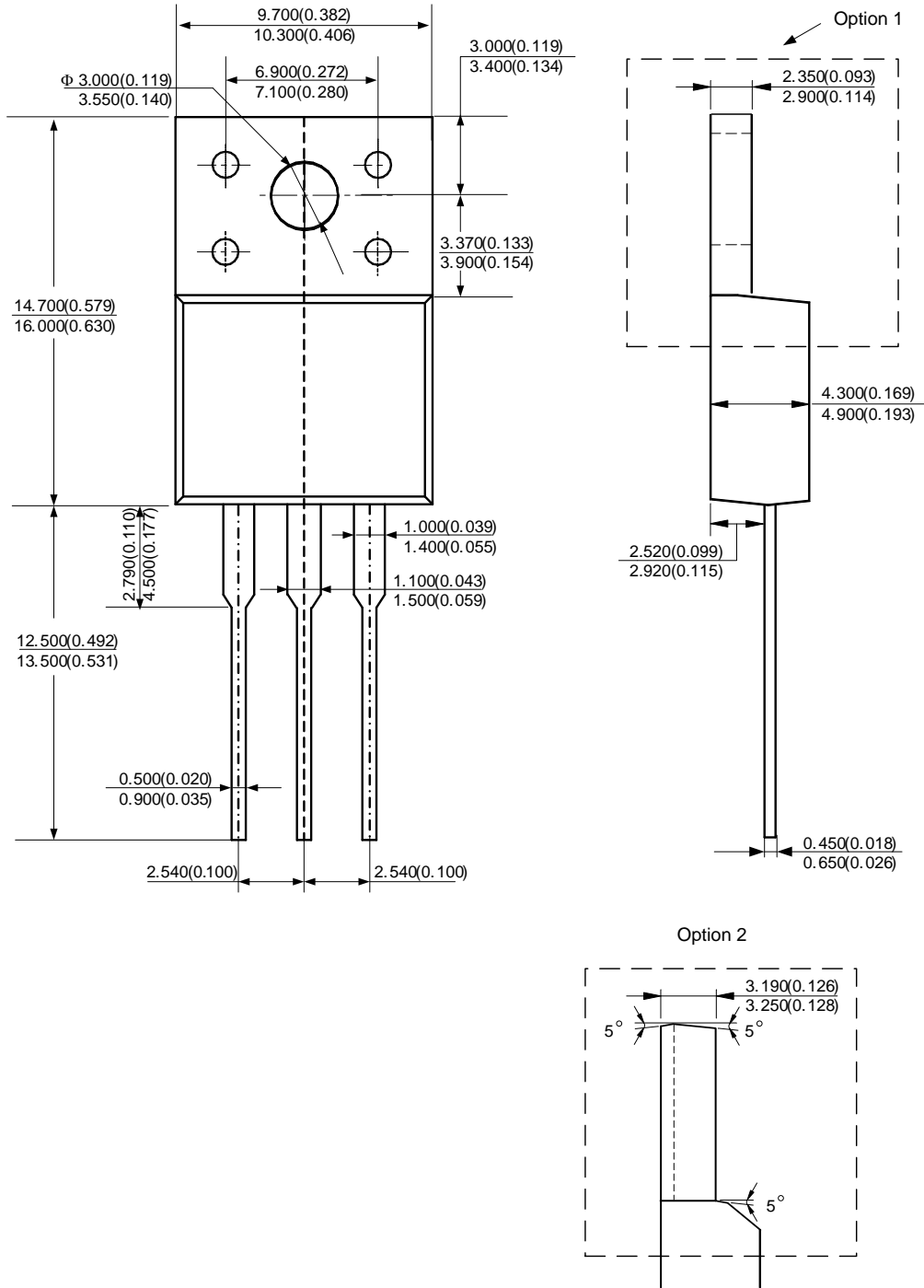

**IMPORTANT NOTICE**

DIODES INCORPORATED MAKES NO WARRANTY OF ANY KIND, EXPRESS OR IMPLIED, WITH REGARDS TO THIS DOCUMENT, INCLUDING, BUT NOT LIMITED TO, THE IMPLIED WARRANTIES OF MERCHANTABILITY AND FITNESS FOR A PARTICULAR PURPOSE (AND THEIR EQUIVALENTS UNDER THE LAWS OF ANY JURISDICTION).

Diodes Incorporated and its subsidiaries reserve the right to make modifications, enhancements, improvements, corrections or other changes without further notice to this document and any product described herein. Diodes Incorporated does not assume any liability arising out of the application or use of this document or any product described herein; neither does Diodes Incorporated convey any license under its patent or trademark rights, nor the rights of others. Any Customer or user of this document or products described herein in such applications shall assume all risks of such use and will agree to hold Diodes Incorporated and all the companies whose products are represented on Diodes Incorporated website, harmless against all damages.

Diodes Incorporated does not warrant or accept any liability whatsoever in respect of any products purchased through unauthorized sales channel. Should Customers purchase or use Diodes Incorporated products for any unintended or unauthorized application, Customers shall indemnify and hold Diodes Incorporated and its representatives harmless against all claims, damages, expenses, and attorney fees arising out of, directly or indirectly, any claim of personal injury or death associated with such unintended or unauthorized application.

Products described herein may be covered by one or more United States, international or foreign patents pending. Product names and markings noted herein may also be covered by one or more United States, international or foreign trademarks.

This document is written in English but may be translated into multiple languages for reference. Only the English version of this document is the final and determinative format released by Diodes Incorporated.

**LIFE SUPPORT**

Diodes Incorporated products are specifically not authorized for use as critical components in life support devices or systems without the express written approval of the Chief Executive Officer of Diodes Incorporated. As used herein:

A. Life support devices or systems are devices or systems which:

1. are intended to implant into the body, or
2. support or sustain life and whose failure to perform when properly used in accordance with instructions for use provided in the labeling can be reasonably expected to result in significant injury to the user.

B. A critical component is any component in a life support device or system whose failure to perform can be reasonably expected to cause the failure of the life support device or to affect its safety or effectiveness.



Customers represent that they have all necessary expertise in the safety and regulatory ramifications of their life support devices or systems, and acknowledge and agree that they are solely responsible for all legal, regulatory and safety-related requirements concerning their products and any use of Diodes Incorporated products in such safety-critical, life support devices or systems, notwithstanding any devices- or systems-related information or support that may be provided by Diodes Incorporated. Further, Customers must fully indemnify Diodes Incorporated and its representatives against any damages arising out of the use of Diodes Incorporated products in such safety-critical, life support devices or systems.

Copyright © 2019, Diodes Incorporated

[www.diodes.com](http://www.diodes.com)

## Looking for pricing, stock, or lifecycle information?

Click below to explore more details on WIN SOURCE:

-  [View MBR20200CTF-G1 on WIN SOURCE](#)
-  [Diodes Incorporated Information](#)

## Optimize Your Supply Chain with WIN SOURCE Solutions

-  Global Sourcing Solution
-  Obsolete Management
-  Cost Control Management
-  Shortage Management
-  Alternative Solution
-  Excess Inventory Management