



# THE DATASHEET OF MJD50T4





## MJD50

# HIGH VOLTAGE FAST-SWITCHING NPN POWER TRANSISTOR

- STMicroelectronics PREFERRED SALESTYPE
- HIGH VOLTAGE CAPABILITY
- SURFACE-MOUNTING TO-252 (DPAK) POWER PACKAGE IN TAPE & REEL (SUFFIX "T4")
- ELECTRICALLY SIMILAR TO TIP50

### APPLICATIONS

- SWITCH MODE POWER SUPPLIES
- AUDIO AMPLIFIERS
- GENERAL PURPOSE SWITCHING AND AMPLIFIER

### DESCRIPTION

The MJD50 is manufactured using Medium Voltage Epitaxial Planar technology, resulting in a rugged high performance cost-effective transistor.

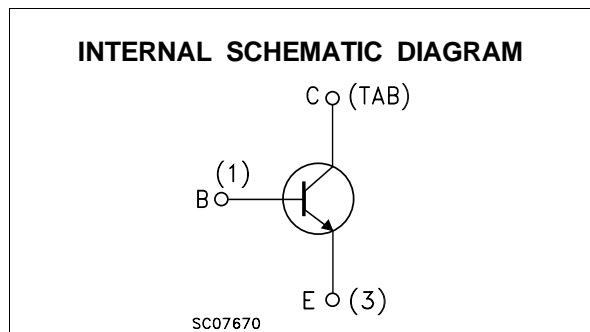
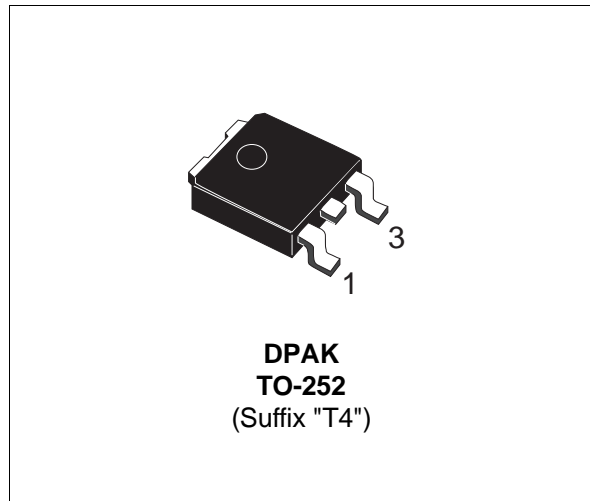

### ABSOLUTE MAXIMUM RATINGS

Symbol	Parameter	Value	Unit
$V_{CBO}$	Collector-Base Voltage ( $I_E = 0$ )	500	V
$V_{CEO}$	Collector-Emitter Voltage ( $I_B = 0$ )	400	V
$V_{EBO}$	Emitter-Base Voltage ( $I_C = 0$ )	5	V
$I_C$	Collector Current	1	A
$I_{CM}$	Collector Peak Current ( $t_p < 5$ ms)	2	A
$I_B$	Base Current	0.6	A
$I_{BM}$	Base Peak Current ( $t_p < 5$ ms)	1.2	A
$P_{tot}$	Total Dissipation at $T_c = 25$ °C	15	W
$T_{stg}$	Storage Temperature	-65 to 150	°C
$T_j$	Max. Operating Junction Temperature	150	°C

# MJD50

## THERMAL DATA

R <sub>thj-case</sub>	Thermal Resistance Junction-case	Max	8.33	°C/W
R <sub>thj-amb</sub>	Thermal Resistance Junction-ambient	Max	100	°C/W

## ELECTRICAL CHARACTERISTICS (T<sub>case</sub> = 25 °C unless otherwise specified)

Symbol	Parameter	Test Conditions	Min.	Typ.	Max.	Unit
I <sub>CES</sub>	Collector Cut-off Current (V <sub>BE</sub> = 0)	V <sub>CE</sub> = 500 V			0.1	mA
I <sub>CEO</sub>	Collector Cut-off Current (I <sub>B</sub> = 0)	V <sub>CE</sub> = 300 V			0.1	mA
I <sub>EBO</sub>	Emitter Cut-off Current (I <sub>C</sub> = 0)	V <sub>EB</sub> = 5 V			1	mA
V <sub>CEO(sus)*</sub>	Collector-Emitter Sustaining Voltage (I <sub>B</sub> = 0)	I <sub>C</sub> = 30 mA	400			V
V <sub>CE(sat)*</sub>	Collector-Emitter Saturation Voltage	I <sub>C</sub> = 1 A I <sub>B</sub> = 0.2 A			1	V
V <sub>BE(on)*</sub>	Base-Emitter On Voltage	I <sub>C</sub> = 1 A V <sub>CE</sub> = 10 V			1.5	V
h <sub>FE*</sub>	DC Current Gain	I <sub>C</sub> = 0.3 A V <sub>CE</sub> = 10 V I <sub>C</sub> = 1 A V <sub>CE</sub> = 10 V	30 10		150	
f <sub>T</sub>	Transition Frequency	I <sub>C</sub> = 0.2 A V <sub>CE</sub> = 10 V f=2MHz	10			MHz
h <sub>fe</sub>	Small Signal Current Gain	I <sub>C</sub> = 0.2 A V <sub>CE</sub> = 10 V f=1kHz	25			

\* Pulsed: Pulse duration = 300 μs, duty cycle 1.5 %

## Safe Operating Area

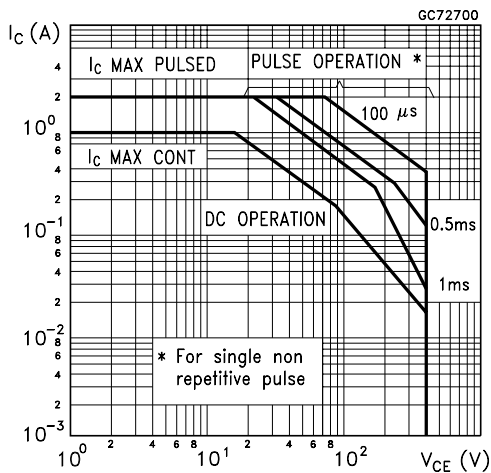

## Derating Curves

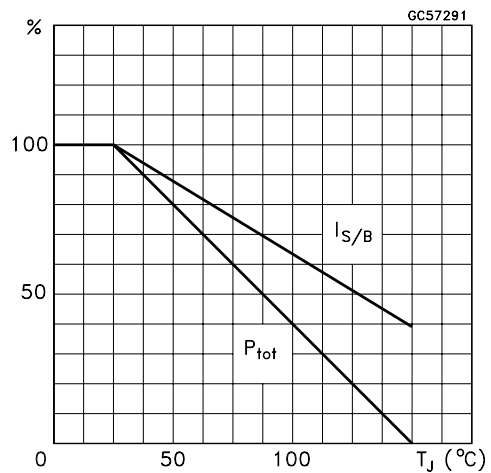

DC Current Gain

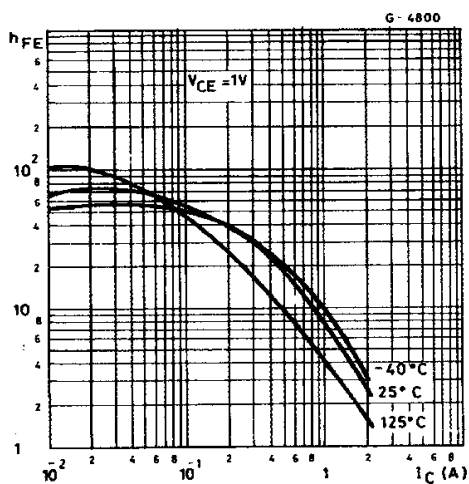

DC Current Gain

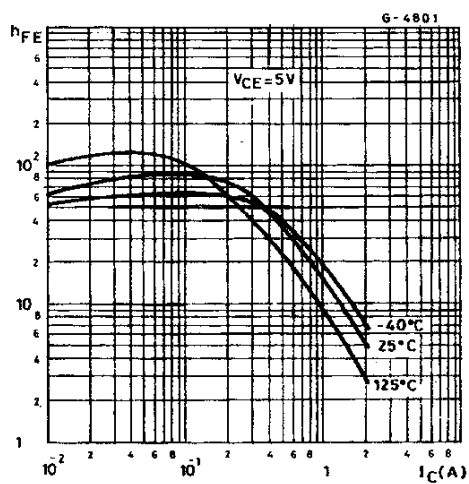

Collector-Emitter Saturation Voltage

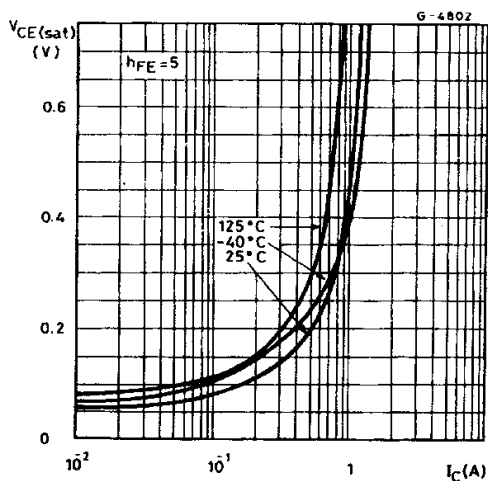

Collector-Emitter Saturation Voltage

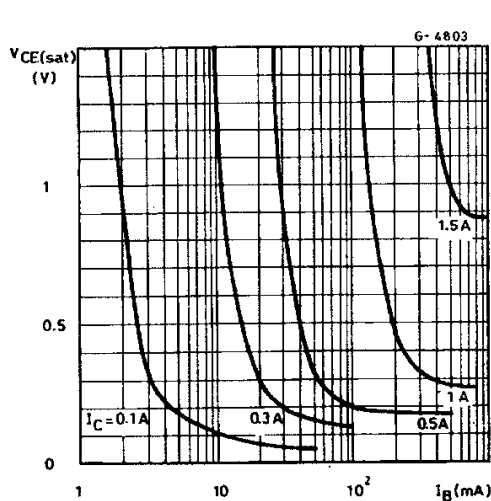

Base-Emitter Saturation Voltage

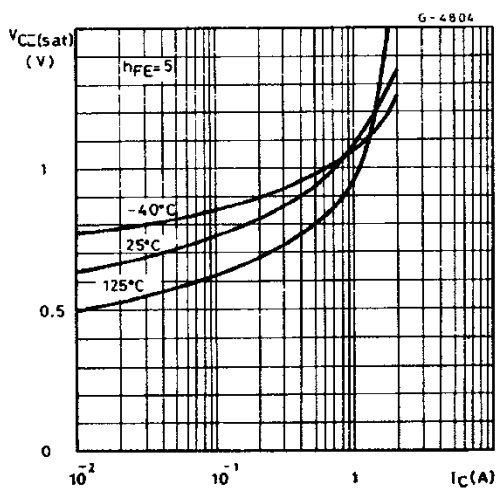

Collector-Base Capacitance

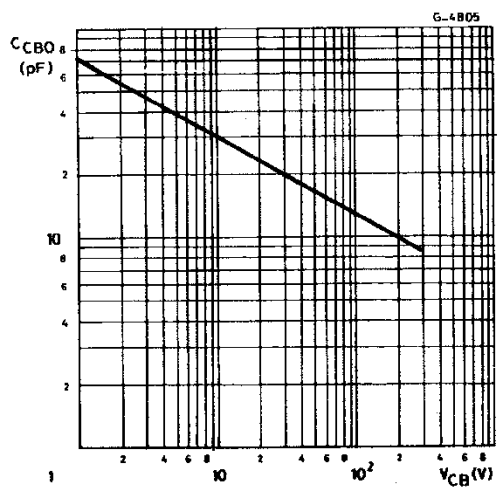

Switching Time Inductive Load

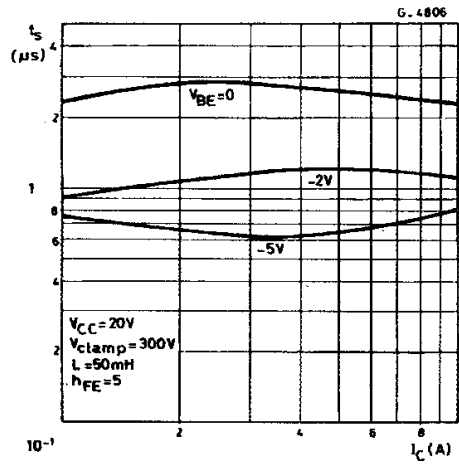

Switching Time Inductive Load

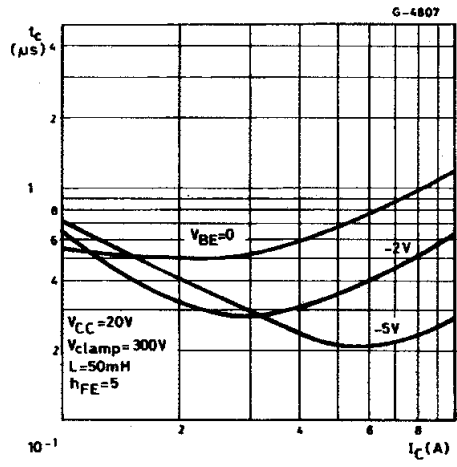

Switching Time Inductive Load

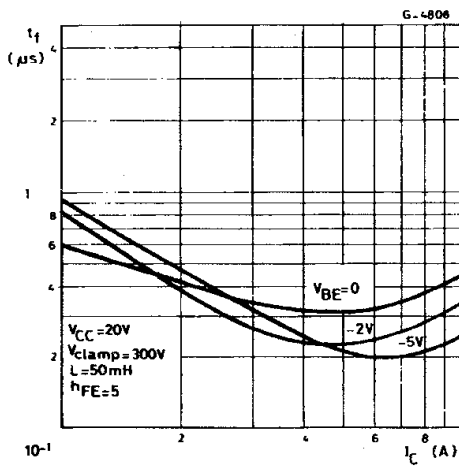

Switching Time Inductive Load

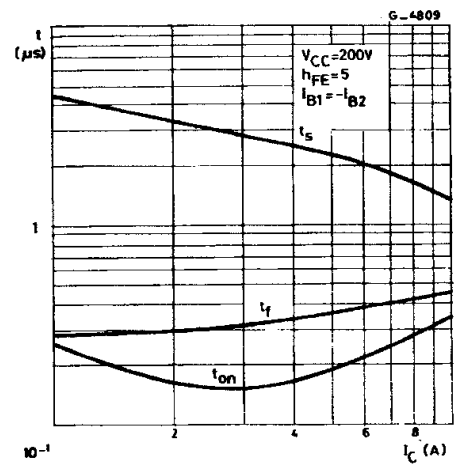

**TO-252 (DPAK) MECHANICAL DATA**

DIM.	mm			inch		
	MIN.	TYP.	MAX.	MIN.	TYP.	MAX.
A	2.20		2.40	0.087		0.094
A1	0.90		1.10	0.035		0.043
A2	0.03		0.23	0.001		0.009
B	0.64		0.90	0.025		0.035
B2	5.20		5.40	0.204		0.213
C	0.45		0.60	0.018		0.024
C2	0.48		0.60	0.019		0.024
D	6.00		6.20	0.236		0.244
E	6.40		6.60	0.252		0.260
G	4.40		4.60	0.173		0.181
H	9.35		10.10	0.368		0.398
L2		0.8			0.031	
L4	0.60		1.00	0.024		0.039
V2	0°		8°	0°		0°

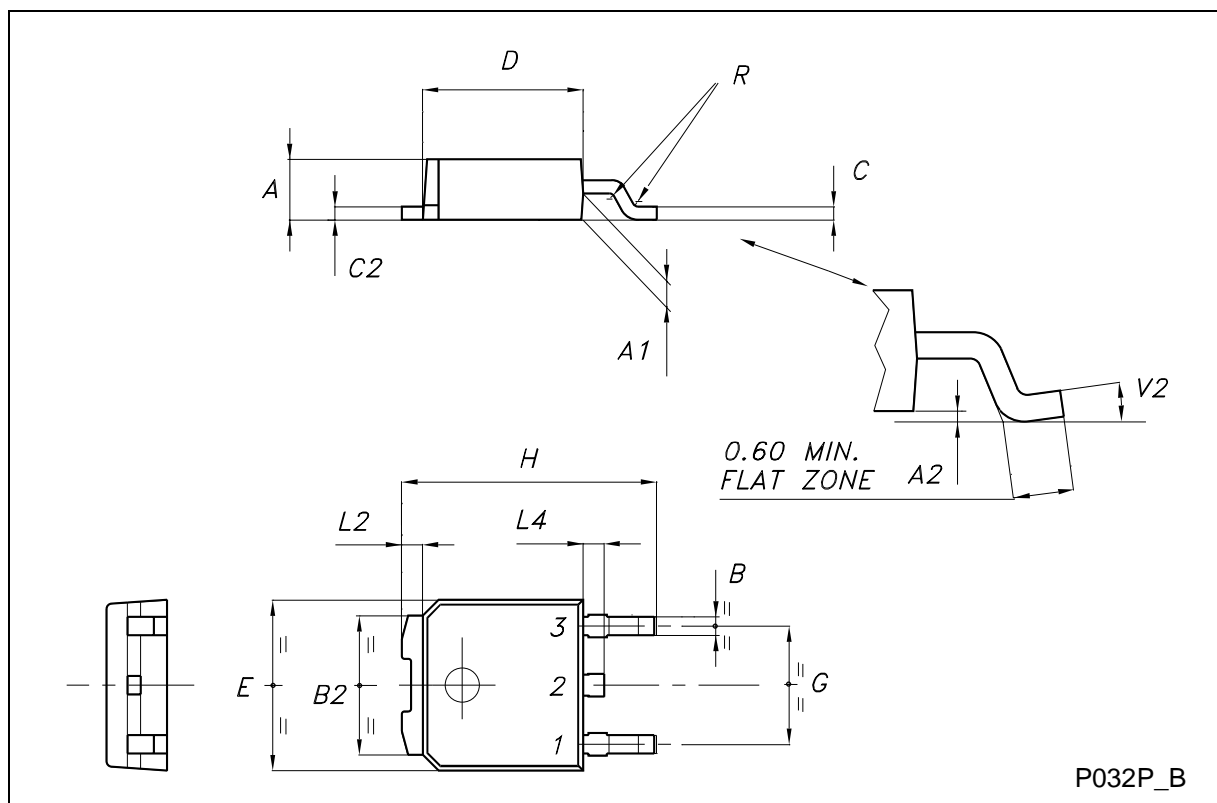

Information furnished is believed to be accurate and reliable. However, STMicroelectronics assumes no responsibility for the consequences of use of such information nor for any infringement of patents or other rights of third parties which may result from its use. No license is granted by implication or otherwise under any patent or patent rights of STMicroelectronics. Specification mentioned in this publication are subject to change without notice. This publication supersedes and replaces all information previously supplied. STMicroelectronics products are not authorized for use as critical components in life support devices or systems without express written approval of STMicroelectronics.

The ST logo is a trademark of STMicroelectronics

© 2000 STMicroelectronics – Printed in Italy – All Rights Reserved



STMicroelectronics GROUP OF COMPANIES

Australia - Brazil - China - Finland - France - Germany - Hong Kong - India - Italy - Japan - Malaysia - Malta - Morocco -  
Singapore - Spain - Sweden - Switzerland - United Kingdom - U.S.A.

<http://www.st.com>

## Looking for pricing, stock, or lifecycle information?

Click below to explore more details on WIN SOURCE:

-  [View MJD50T4 on WIN SOURCE](#)
-  [STMicroelectronics](#) Information

## Optimize Your Supply Chain with WIN SOURCE Solutions

-  Global Sourcing Solution
-  Obsolete Management
-  Cost Control Management
-  Shortage Management
-  Alternative Solution
-  Excess Inventory Management