



# THE DATASHEET OF MPC8265ACZUMHBC



# MPC8260A

## PowerQUICC™ II Integrated Communications Processor

### Hardware Specifications

This document contains detailed information on power considerations, DC/AC electrical characteristics, and AC timing specifications for .25μm (HiP4) devices in the PowerQUICC II™ MPC8260 communications processor family. These devices include the MPC8260, the MPC8255, the MPC8264, the MPC8265, and the MPC8266. Throughout this document, these devices are collectively referred to as the MPC826xA.

#### Contents

1. Features	2
2. Electrical and Thermal Characteristics	7
3. Clock Configuration Modes	23
4. Pinout	33
5. Package Description	46
6. Ordering Information	48
7. Document Revision History	48

Figure 1 shows the block diagram for the MPC8266, the HiP4 superset device. Shaded portions indicate functionality that is not available on all devices; refer to the notes.



- Notes:**
- <sup>1</sup> MPC8264
  - <sup>2</sup> MPC8265
  - <sup>3</sup> MPC8266
  - <sup>4</sup> Not on MPC8255
  - <sup>5</sup> 4 TDM ports on the MPC8255
  - <sup>6</sup> 2 MII ports on the MPC8255

Figure 1. MPC8266 Block Diagram

# 1 Features

The major features of the MPC826xA family are as follows:

- Dual-issue integer core
  - A core version of the EC603e microprocessor
  - System core microprocessor supporting frequencies of 150–300 MHz
  - Separate 16-Kbyte data and instruction caches:
    - Four-way set associative
    - Physically addressed
    - LRU replacement algorithm

- PowerPC architecture-compliant memory management unit (MMU)
- Common on-chip processor (COP) test interface
- High-performance (6.6–7.65 SPEC95 benchmark at 300 MHz; 1.68 MIPS/MHz without inlining and 1.90 Dhrystones MIPS/MHz with
- Supports bus snooping for data cache coherency
- Floating-point unit (FPU)
- Separate power supply for internal logic and for I/O
- Separate PLLs for G2 core and for the CPM
  - G2 core and CPM can run at different frequencies for power/performance optimization
  - Internal core/bus clock multiplier that provides 1.5:1, 2:1, 2.5:1, 3:1, 3.5:1, 4:1, 5:1, 6:1 ratios
  - Internal CPM/bus clock multiplier that provides 2:1, 2.5:1, 3:1, 3.5:1, 4:1, 5:1, 6:1 ratios
- 64-bit data and 32-bit address 60x bus
  - Bus supports multiple master designs
  - Supports single- and four-beat burst transfers
  - 64-, 32-, 16-, and 8-bit port sizes controlled by on-chip memory controller
  - Supports data parity or ECC and address parity
- 32-bit data and 18-bit address local bus
  - Single-master bus, supports external slaves
  - Eight-beat burst transfers
  - 32-, 16-, and 8-bit port sizes controlled by on-chip memory controller
- 60x-to-PCI bridge (MPC8265 and MPC8266 only)
  - Programmable host bridge and agent
  - 32-bit data bus, 66 MHz, 3.3 V
  - Synchronous and asynchronous 60x and PCI clock modes
  - All internal address space available to external PCI host
  - DMA for memory block transfers
  - PCI-to-60x address remapping
- System interface unit (SIU)
  - Clock synthesizer
  - Reset controller
  - Real-time clock (RTC) register
  - Periodic interrupt timer
  - Hardware bus monitor and software watchdog timer
  - IEEE Std. 1149.1™ standard JTAG test access port
- Twelve-bank memory controller
  - Glueless interface to SRAM, page mode SDRAM, DRAM, EPROM, Flash and other user-definable peripherals
  - Byte write enables and selectable parity generation

- 32-bit address decodes with programmable bank size
- Three user programmable machines, general-purpose chip-select machine, and page-mode pipeline SDRAM machine
- Byte selects for 64 bus width (60x) and byte selects for 32 bus width (local)
- Dedicated interface logic for SDRAM
- CPU core can be disabled and the device can be used in slave mode to an external core
- Communications processor module (CPM)
  - Embedded 32-bit communications processor (CP) uses a RISC architecture for flexible support for communications protocols
  - Interfaces to G2 core through on-chip 32-Kbyte dual-port RAM and DMA controller
  - Serial DMA channels for receive and transmit on all serial channels
  - Parallel I/O registers with open-drain and interrupt capability
  - Virtual DMA functionality executing memory-to-memory and memory-to-I/O transfers
  - Three fast communications controllers supporting the following protocols (only FCC1 and FCC2 on the MPC8255):
    - 10/100-Mbit Ethernet/IEEE Std. 802.3@ CDMA/CS interface through media independent interface (MII)
    - ATM—Full-duplex SAR protocols at 155 Mbps, through UTOPIA interface, AAL5, AAL1, AAL0 protocols, TM 4.0 CBR, VBR, UBR, ABR traffic types, up to 16 K external connections
    - Transparent
    - HDLC—Up to T3 rates (clear channel)
  - Two multichannel controllers (MCCs) (only MCC2 on the MPC8255)
    - Each MCC handles 128 serial, full-duplex, 64-Kbps data channels. Each MCC can be split into four subgroups of 32 channels each.
    - Almost any combination of subgroups can be multiplexed to single or multiple TDM interfaces up to four TDM interfaces per MCC
  - Four serial communications controllers (SCCs) identical to those on the MPC860, supporting the digital portions of the following protocols:
    - Ethernet/IEEE 802.3 CDMA/CS
    - HDLC/SDLC and HDLC bus
    - Universal asynchronous receiver transmitter (UART)
    - Synchronous UART
    - Binary synchronous (BISYNC) communications
    - Transparent
  - Two serial management controllers (SMCs), identical to those of the MPC860
    - Provide management for BRI devices as general circuit interface (GCI) controllers in time-division-multiplexed (TDM) channels

- Transparent
- UART (low-speed operation)
- One serial peripheral interface identical to the MPC860 SPI
- One inter-integrated circuit (I<sup>2</sup>C) controller (identical to the MPC860 I<sup>2</sup>C controller)
  - Microwire compatible
  - Multiple-master, single-master, and slave modes
- Up to eight TDM interfaces (four on the MPC8255)
  - Supports two groups of four TDM channels for a total of eight TDMs
  - 2,048 bytes of SI RAM
  - Bit or byte resolution
  - Independent transmit and receive routing, frame synchronization
  - Supports T1, CEPT, T1/E1, T3/E3, pulse code modulation highway, ISDN basic rate, ISDN primary rate, Freescale interchip digital link (IDL), general circuit interface (GCI), and user-defined TDM serial interfaces
- Eight independent baud rate generators and 20 input clock pins for supplying clocks to FCCs, SCCs, SMCs, and serial channels
- Four independent 16-bit timers that can be interconnected as two 32-bit timers

Additional features of the MPC826xA family are as follows:

- CPM
  - 32-Kbyte dual-port RAM
  - Additional MCC host commands
  - Eight transfer transmission convergence (TC) layers between the TDMs and FCC2 to support inverse multiplexing for ATM capabilities (IMA) (MPC8264 and MPC8266 only)
- CPM multiplexing
  - FCC2 can also be connected to the TC layer.
- TC layer (MPC8264 and MPC8266 only)
  - Each of the 8 TDM channels is routed in hardware to a TC layer block
    - Protocol-specific overhead bits may be discarded or routed to other controllers by the SI
    - Performing ATM TC layer functions (according to ITU-T I.432)
      - Transmit (Tx) updates
        - Cell HEC generation
        - Payload scrambling using self synchronizing scrambler (programmable by the user)
        - Coset generation (programmable by the user)
        - Cell rate by inserting idle/unassigned cells
      - Receive (Rx) updates
        - Cell delineation using bit by bit HEC checking and programmable ALPHA and DELTA parameters for the delineation state machine
        - Payload descrambling using self synchronizing scrambler (programmable by the user)

- Coset removing (programmable by the user)
- Filtering idle/unassigned cells (programmable by the user)
- Performing HEC error detection and single bit error correction (programmable by user)
- Generating loss of cell delineation status/interrupt (LOC/LCD)
- Operates with FCC2 (UTOPIA 8)
- Provides serial loop back mode
- Cell echo mode is provided
- Supports both FCC transmit modes
  - External rate mode—Idle cells are generated by the FCC (microcode) to control data rate.
  - Internal rate mode (sub-rate)—FCC transfers only the data cells using the required data rate. The TC layer generates idle/unassigned cells to maintain the line bit rate.
- Supports TC-layer and PMD-WIRE interface (according to the ATM-Forum af-phy-0063.000)
- Cell counters for performance monitoring
  - 16-bit counters count
    - HEC error cells
    - HEC single bit error and corrected cells
    - Idle/unassigned cells filtered
    - Idle/unassigned cells transmitted
    - Transmitted ATM cells
    - Received ATM cells
  - Maskable interrupt is sent to the host when a counter expires
- Overrun (Rx cell FIFO) and underrun (Tx cell FIFO) condition produces maskable interrupt
- May be operated at E1 and DS-1 rates. In addition, xDSL applications at bit rates up to 10 Mbps are supported
- PCI bridge (MPC8265 and MPC8266 only)
  - PCI Specification Revision 2.2 compliant and supports frequencies up to 66 MHz
  - On-chip arbitration
  - Support for PCI to 60x memory and 60x memory to PCI streaming
  - PCI Host Bridge or Peripheral capabilities
  - Includes 4 DMA channels for the following transfers:
    - PCI-to-60x to 60x-to-PCI
    - 60x-to-PCI to PCI-to-60x
    - PCI-to-60x to PCI-to-60x
    - 60x-to-PCI to 60x-to-PCI
  - Includes all of the configuration registers (which are automatically loaded from the EPROM and used to configure the MPC8265) required by the PCI standard as well as message and doorbell registers
  - Supports the I<sub>2</sub>O standard

- Hot-Swap friendly (supports the Hot Swap Specification as defined by PICMG 2.1 R1.0 August 3, 1998)
- Support for 66 MHz, 3.3 V specification
- 60x-PCI bus core logic which uses a buffer pool to allocate buffers for each port
- Makes use of the local bus signals, so there is no need for additional pins

## 2 Electrical and Thermal Characteristics

This section provides AC and DC electrical specifications and thermal characteristics for the MPC826xA.

### 2.1 DC Electrical Characteristics

This section describes the DC electrical characteristics for the MPC826xA. [Table 1](#) shows the maximum electrical ratings.

**Table 1. Absolute Maximum Ratings<sup>1</sup>**

Rating	Symbol	Value	Unit
Core supply voltage <sup>2</sup>	VDD	-0.3 – 2.5	V
PLL supply voltage <sup>2</sup>	VCCSYN	-0.3 – 2.5	V
I/O supply voltage <sup>3</sup>	VDDH	-0.3 – 4.0	V
Input voltage <sup>4</sup>	VIN	GND(-0.3) – 3.6	V
Junction temperature	T <sub>j</sub>	120	°C
Storage temperature range	T <sub>STG</sub>	(-55) – (+150)	°C

<sup>1</sup> Absolute maximum ratings are stress ratings only; functional operation (see [Table 2](#)) at the maximums is not guaranteed. Stress beyond those listed may affect device reliability or cause permanent damage.

<sup>2</sup> **Caution:** VDD/VCCSYN must not exceed VDDH by more than 0.4 V at any time, including during power-on reset.

<sup>3</sup> **Caution:** VDDH can exceed VDD/VCCSYN by 3.3 V during power on reset by no more than 100 mSec. VDDH should not exceed VDD/VCCSYN by more than 2.5 V during normal operation.

<sup>4</sup> **Caution:** VIN must not exceed VDDH by more than 2.5 V at any time, including during power-on reset.

Table 2 lists recommended operational voltage conditions.

**Table 2. Recommended Operating Conditions<sup>1</sup>**

Rating	Symbol	Value			Unit
Core supply voltage	VDD	1.7 – 1.9 <sup>2</sup>	1.7–2.1 <sup>3</sup>	1.9 – 2.2 <sup>4</sup>	V
PLL supply voltage	VCCSYN	1.7 – 1.9 <sup>2</sup>	1.7–2.1 <sup>3</sup>	1.9–2.2 <sup>4</sup>	V
I/O supply voltage	VDDH	3.135 – 3.465			V
Input voltage	VIN	GND (–0.3) – 3.465			V
Junction temperature (maximum)	T <sub>j</sub>	105 <sup>5</sup>			°C
Ambient temperature	T <sub>A</sub>	0–70 <sup>5</sup>			°C

<sup>1</sup> **Caution:** These are the recommended and tested operating conditions. Proper device operating outside of these conditions is not guaranteed.

<sup>2</sup> CPU frequency less than or equal to 200 MHz.

<sup>3</sup> CPU frequency greater than 200 MHz but less than 233 MHz.

<sup>4</sup> CPU frequency greater than or equal to 233 MHz.

<sup>5</sup> Note that for extended temperature parts the range is  $(-40)_{T_A} - 105_{T_j}$ .

**NOTE: Core, PLL, and I/O Supply Voltages**

VDDH, VCCSYN, and VDD must track each other and both must vary in the same direction—in the positive direction (+5% and +0.1 Vdc) or in the negative direction (–5% and –0.1 Vdc).

This device contains circuitry protecting against damage due to high static voltage or electrical fields; however, it is advised that normal precautions be taken to avoid application of any voltages higher than maximum-rated voltages to this high-impedance circuit. Reliability of operation is enhanced if unused inputs are tied to an appropriate logic voltage level (either GND or V<sub>CC</sub>).

Figure 2 shows the undershoot and overshoot voltage of the 60x and local bus memory interface of the MPC8280. Note that in PCI mode the I/O interface is different.

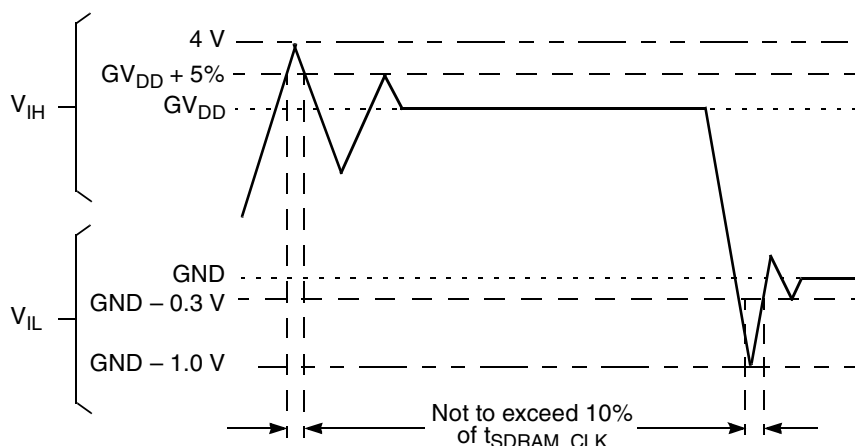

**Figure 2. Overshoot/Undershoot Voltage**

Table 3 shows DC electrical characteristics.

**Table 3. DC Electrical Characteristics<sup>1</sup>**

Characteristic	Symbol	Min	Max	Unit
Input high voltage, all inputs except CLKIN	$V_{IH}$	2.0	3.465	V
Input low voltage	$V_{IL}$	GND	0.8	V
CLKIN input high voltage	$V_{IHC}$	2.4	3.465	V
CLKIN input low voltage	$V_{ILC}$	GND	0.4	V
Input leakage current, $V_{IN} = V_{DDH}^2$	$I_{IN}$	—	10	$\mu A$
Hi-Z (off state) leakage current, $V_{IN} = V_{DDH}^2$	$I_{OZ}$	—	10	$\mu A$
Signal low input current, $V_{IL} = 0.8$ V	$I_L$	—	1	$\mu A$
Signal high input current, $V_{IH} = 2.0$ V	$I_H$	—	1	$\mu A$
Output high voltage, $I_{OH} = -2$ mA except XFC, UTOPIA mode, and open drain pins  In UTOPIA mode: $I_{OH} = -8.0$ mA PA[0-31] PB[4-31] PC[0-31] PD[4-31]	$V_{OH}$	2.4	—	V
In UTOPIA mode: $I_{OL} = 8.0$ mA PA[0-31] PB[4-31] PC[0-31] PD[4-31]	$V_{OL}$	—	0.5	V

**Table 3. DC Electrical Characteristics<sup>1</sup> (continued)**

Characteristic	Symbol	Min	Max	Unit
$I_{OL} = 7.0 \text{ mA}$ $\overline{BR}$ $\overline{BG}$ $\overline{ABB/IRQ2}$ $\overline{TS}$ $A[0-31]$ $\overline{TT[0-4]}$ $\overline{TBST}$ $\overline{TSIZE[0-3]}$ $\overline{AACK}$ $\overline{ARTRY}$ $\overline{DBG}$ $\overline{DBB/IRQ3}$ $\overline{D[0-63]}$ $\overline{DP(0)/RSRV/EXT\_BR2}$ $\overline{DP(1)/IRQ1/EXT\_BG2}$ $\overline{DP(2)/TLBISYNC/IRQ2/EXT\_DBG2}$ $\overline{DP(3)/IRQ3/EXT\_BR3/CKSTP\_OUT}$ $\overline{DP(4)/IRQ4/EXT\_BG3/CORE\_SREST}$ $\overline{DP(5)/TBEN/IRQ5/EXT\_DBG3}$ $\overline{DP(6)/CSE(0)/IRQ6}$ $\overline{DP(7)/CSE(1)/IRQ7}$ $\overline{PSDVAL}$ $\overline{TA}$ $\overline{TEA}$ $\overline{GBL/IRQ1}$ $\overline{CI/BADDR29/IRQ2}$ $\overline{WT/BADDR30/IRQ3}$ $\overline{L2\_HIT/IRQ4}$ $\overline{CPU\_BG/BADDR31/IRQ5}$ $\overline{CPU\_DBG}$ $\overline{CPU\_BR}$ $\overline{IRQ0/NMI\_OUT}$ $\overline{IRQ7/INT\_OUT/APE}$ $\overline{PORESET}$ $\overline{HRESET}$ $\overline{SRESET}$ $\overline{RSTCONF}$ $\overline{QREQ}$	$V_{OL}$	—	0.4	V

Table 3. DC Electrical Characteristics<sup>1</sup> (continued)

Characteristic	Symbol	Min	Max	Unit
$I_{OL} = 5.3\text{mA}$ $\overline{CS}[0-9]$ $\overline{CS}(10)/\overline{BCTL1}$ $\overline{CS}(11)/\overline{AP}(0)$ $\overline{BADDR}[27-28]$ $\overline{ALE}$ $\overline{BCTL0}$ $\overline{PWE}(0:7)/\overline{PSDDQM}(0:7)/\overline{PBS}(0:7)$ $\overline{PSDA10}/\overline{PGPL0}$ $\overline{PSDWE}/\overline{PGPL1}$ $\overline{POE}/\overline{PSDRAS}/\overline{PGPL2}$ $\overline{PSDCAS}/\overline{PGPL3}$ $\overline{PGTA}/\overline{PUPMWAIT}/\overline{PGPL4}/\overline{PPBS}$ $\overline{PSDAMUX}/\overline{PGPL5}$ $\overline{LWE}[0-3]/\overline{LSDDQM}[0-3]/\overline{LBS}[0-3]/\overline{PCI\_CFG}[0-3]^3$ $\overline{LSDA10}/\overline{LGPL0}/\overline{PCI\_MODCKH0}^3$ $\overline{LSDWE}/\overline{LGPL1}/\overline{PCI\_MODCKH1}^3$ $\overline{LOE}/\overline{LSDRAS}/\overline{LGPL2}/\overline{PCI\_MODCKH2}^3$ $\overline{LSDCAS}/\overline{LGPL3}/\overline{PCI\_MODCKH3}^3$ $\overline{LGTA}/\overline{LUPMWAIT}/\overline{LGPL4}/\overline{LPBS}$ $\overline{LSDAMUX}/\overline{LGPL5}/\overline{PCI\_MODCK}^3$ $\overline{LWR}$ $\overline{MODCK1}/\overline{AP}(1)/\overline{TC}(0)/\overline{BNKSEL}(0)$ $\overline{MODCK2}/\overline{AP}(2)/\overline{TC}(1)/\overline{BNKSEL}(1)$ $\overline{MODCK3}/\overline{AP}(3)/\overline{TC}(2)/\overline{BNKSEL}(2)$ $I_{OL} = 3.2\text{mA}$ $\overline{L\_A14}/\overline{PAR}^3$ $\overline{L\_A15}/\overline{FRAME}^3/\overline{SMI}$ $\overline{L\_A16}/\overline{TRDY}^3$ $\overline{L\_A17}/\overline{IRDY}^3/\overline{CKSTP\_OUT}$ $\overline{L\_A18}/\overline{STOP}^3$ $\overline{L\_A19}/\overline{DEVSEL}^3$ $\overline{L\_A20}/\overline{IDSEL}^3$ $\overline{L\_A21}/\overline{PERR}^3$ $\overline{L\_A22}/\overline{SERR}^3$ $\overline{L\_A23}/\overline{REQ0}^3$ $\overline{L\_A24}/\overline{REQ1}^3/\overline{HSEJSW}^3$ $\overline{L\_A25}/\overline{GNT0}^3$ $\overline{L\_A26}/\overline{GNT1}^3/\overline{HSLED}^3$ $\overline{L\_A27}/\overline{GNT2}^3/\overline{HSENUM}^3$ $\overline{L\_A28}/\overline{RST}^3/\overline{CORE\_SRESET}$ $\overline{L\_A29}/\overline{INTA}^3$ $\overline{L\_A30}/\overline{REQ2}^3$ $\overline{L\_A31}$ $\overline{LCL\_D}(0-31)/\overline{AD}(0-31)^3$ $\overline{LCL\_DP}(0-3)/\overline{C}/\overline{BE}(0-3)^3$ $\overline{PA}[0-31]$ $\overline{PB}[4-31]$ $\overline{PC}[0-31]$ $\overline{PD}[4-31]$ $\overline{TDO}$	$V_{OL}$	—	0.4	V

<sup>1</sup> The default configuration of the CPM pins ( $\overline{PA}[0-31]$ ,  $\overline{PB}[4-31]$ ,  $\overline{PC}[0-31]$ ,  $\overline{PD}[4-31]$ ) is input. To prevent excessive DC current, it is recommended to either pull unused pins to GND or VDDH, or to configure them as outputs.

<sup>2</sup> The leakage current is measured for nominal VDD, VCCSYN, and VDD.

<sup>3</sup> MPC8265 and MPC8266 only.

## 2.2 Thermal Characteristics

Table 4 describes thermal characteristics.

**Table 4. Thermal Characteristics for 480 TBGA Package**

Characteristics	Symbol	Value	Unit	Air Flow
Junction to ambient	$\theta_{JA}$	13 <sup>1</sup>	°C/W	NC <sup>2</sup>
		10 <sup>1</sup>		1 m/s
		11 <sup>3</sup>		NC
		8 <sup>3</sup>		1 m/s
Junction to board <sup>4</sup>	$\theta_{JB}$	4	°C/W	—
Junction to case <sup>5</sup>	$\theta_{JC}$	1.1	°C/W	—

<sup>1</sup> Assumes a single layer board with no thermal vias

<sup>2</sup> Natural convection

<sup>3</sup> Assumes a four layer board

<sup>4</sup> Thermal resistance between the die and the printed circuit board per JEDEC JESD51-8. Board temperature is measured on the top surface of the board near the package.

<sup>5</sup> Thermal resistance between the die and the case top surface as measured by the cold plate method (MIL SPEC-883 Method 1012.1).

## 2.3 Power Considerations

The average chip-junction temperature,  $T_J$ , in °C can be obtained from the following:

$$T_J = T_A + (P_D \times \theta_{JA}) \quad (1)$$

where

$T_A$  = ambient temperature °C

$\theta_{JA}$  = package thermal resistance, junction to ambient, °C/W

$P_D = P_{INT} + P_{I/O}$

$P_{INT} = I_{DD} \times V_{DD}$  Watts (chip internal power)

$P_{I/O}$  = power dissipation on input and output pins (determined by user)

For most applications  $P_{I/O} < 0.3 \times P_{INT}$ . If  $P_{I/O}$  is neglected, an approximate relationship between  $P_D$  and  $T_J$  is the following:

$$P_D = K / (T_J + 273^\circ \text{C}) \quad (2)$$

Solving equations (1) and (2) for K gives:

$$K = P_D \times (T_A + 273^\circ \text{C}) + \theta_{JA} \times P_D^2 \quad (3)$$

where  $K$  is a constant pertaining to the particular part.  $K$  can be determined from equation (3) by measuring  $P_D$  (at equilibrium) for a known  $T_A$ . Using this value of  $K$ , the values of  $P_D$  and  $T_J$  can be obtained by solving equations (1) and (2) iteratively for any value of  $T_A$ .

### 2.3.1 Layout Practices

Each  $V_{CC}$  pin should be provided with a low-impedance path to the board's power supply. Each ground pin should likewise be provided with a low-impedance path to ground. The power supply pins drive distinct groups of logic on chip. The  $V_{CC}$  power supply should be bypassed to ground using at least four 0.1  $\mu\text{F}$  by-pass capacitors located as close as possible to the four sides of the package. The capacitor leads and associated printed circuit traces connecting to chip  $V_{CC}$  and ground should be kept to less than half an inch per capacitor lead. A four-layer board is recommended, employing two inner layers as  $V_{CC}$  and GND planes.

All output pins on the MPC826xA have fast rise and fall times. Printed circuit (PC) trace interconnection length should be minimized in order to minimize overdamped conditions and reflections caused by these fast output switching times. This recommendation particularly applies to the address and data buses. Maximum PC trace lengths of six inches are recommended. Capacitance calculations should consider all device loads as well as parasitic capacitances due to the PC traces. Attention to proper PCB layout and bypassing becomes especially critical in systems with higher capacitive loads because these loads create higher transient currents in the  $V_{CC}$  and GND circuits. Pull up all unused inputs or signals that will be inputs during reset. Special care should be taken to minimize the noise levels on the PLL supply pins.

Table 5 provides preliminary, estimated power dissipation for various configurations. Note that suitable thermal management is required for conditions above  $P_D = 3 \text{ W}$  (when the ambient temperature is  $70^\circ\text{C}$  or greater) to ensure the junction temperature does not exceed the maximum specified value. Also note that the I/O power should be included when determining whether to use a heat sink.

**Table 5. Estimated Power Dissipation for Various Configurations<sup>1</sup>**

Bus (MHz)	CPM Multiplier	Core CPU Multiplier	CPM (MHz)	CPU (MHz)	$P_{INT}(W)^2$			
					Vddl 1.8 Volts		Vddl 2.0 Volts	
					Nominal	Maximum	Nominal	Maximum
66.66	2	3	133	200	1.2	2	1.8	2.3
66.66	2.5	3	166	200	1.3	2.1	1.9	2.3
66.66	3	4	200	266	—	—	2.3	2.9
66.66	3	4.5	200	300	—	—	2.4	3.1
83.33	2	3	166	250	—	—	2.2	2.8
83.33	2	3	166	250	—	—	2.2	2.8
83.33	2.5	3.5	208	291	—	—	2.4	3.1

<sup>1</sup> Test temperature = room temperature ( $25^\circ\text{C}$ )

<sup>2</sup>  $P_{INT} = I_{DD} \times V_{DD}$  Watts

## 2.4 AC Electrical Characteristics

The following sections include illustrations and tables of clock diagrams, signals, and CPM outputs and inputs for the 66 MHz MPC826xA device. Note that AC timings are based on a 50-pf load. Typical output buffer impedances are shown in [Table 6](#).

**Table 6. Output Buffer Impedances<sup>1</sup>**

Output Buffers	Typical Impedance ( $\Omega$ )
60x bus	40
Local bus	40
Memory controller	40
Parallel I/O	46
PCI	25

<sup>1</sup> These are typical values at 65° C. The impedance may vary by  $\pm 25\%$  with process and temperature.

[Table 7](#) lists CPM output characteristics.

**Table 7. AC Characteristics for CPM Outputs<sup>1</sup>**

Spec Number		Characteristic	Max Delay (ns)		Min Delay (ns)	
Max	Min		66 MHz	83 MHz	66 MHz	83 MHz
sp36a	sp37a	FCC outputs—internal clock (NMSI)	6	5.5	1	1
sp36b	sp37b	FCC outputs—external clock (NMSI)	14	12	2	1
sp40	sp41	TDM outputs/SI	25	16	5	4
sp38a	sp39a	SCC/SMC/SPI/I2C outputs—internal clock (NMSI)	19	16	1	0.5
sp38b	sp39b	Ex_SCC/SMC/SPI/I2C outputs—external clock (NMSI)	19	16	2	1
sp42	sp43	TIMER/IDMA outputs	14	11	1	0.5
sp42a	sp43a	PIO outputs	14	11	0.5	0.5

<sup>1</sup> Output specifications are measured from the 50% level of the rising edge of CLKIN to the 50% level of the signal. Timings are measured at the pin.

Table 8 lists CPM input characteristics.

**Table 8. AC Characteristics for CPM Inputs<sup>1</sup>**

Spec Number		Characteristic	Setup (ns)		Hold (ns)	
Max	Min		66 MHz	83 MHz	66 MHz	83 MHz
sp16a	sp17a	FCC inputs—internal clock (NMSI)	10	8	0	0
sp16b	sp17b	FCC inputs—external clock (NMSI)	3	2.5	3	2
sp20	sp21	TDM inputs/SI	15	12	12	10
sp18a	sp19a	SCC/SMC/SPI/I2C inputs—internal clock (NMSI)	20	16	0	0
sp18b	sp19b	SCC/SMC/SPI/I2C inputs—external clock (NMSI)	5	4	5	4
sp22	sp23	PIO/TIMER/IDMA inputs	10	8	3	3

<sup>1</sup> Input specifications are measured from the 50% level of the signal to the 50% level of the rising edge of CLKIN. Timings are measured at the pin.

Note that although the specifications generally reference the rising edge of the clock, the following AC timing diagrams also apply when the falling edge is the active edge.

Figure 3 shows the FCC external clock.

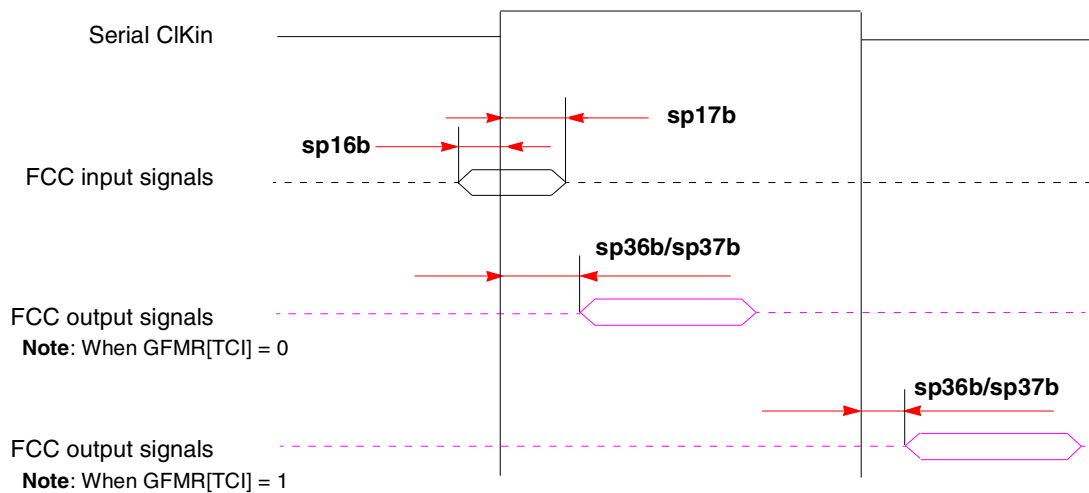

**Figure 3. FCC External Clock Diagram**

Figure 4 shows the FCC internal clock.

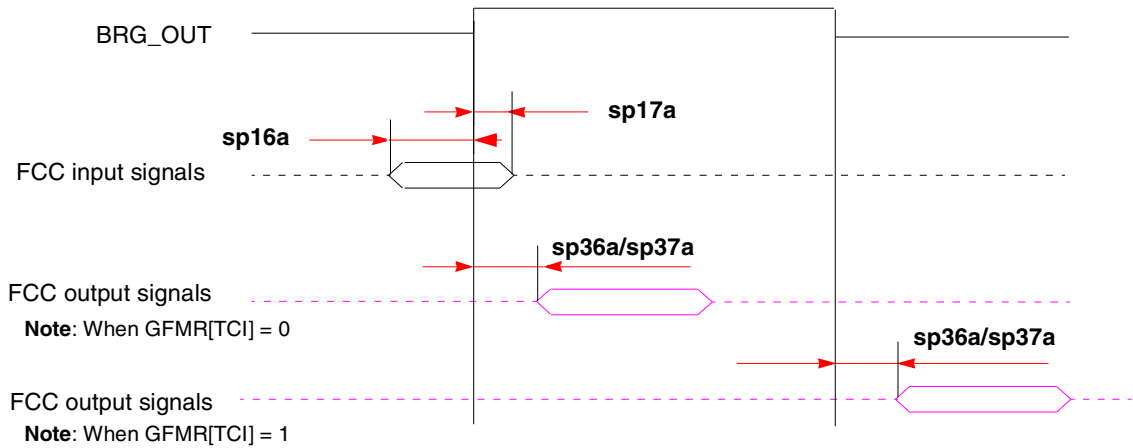
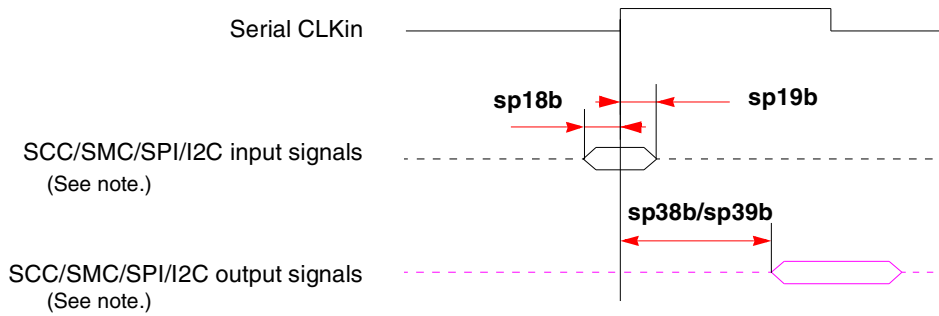

Figure 4. FCC Internal Clock Diagram

Figure 5 shows the SCC/SMC/SPI/I<sup>2</sup>C external clock.



**Note:** There are four possible timing conditions for SCC and SPI:

1. Input sampled on the rising edge and output driven on the rising edge (shown).
2. Input sampled on the rising edge and output driven on the falling edge.
3. Input sampled on the falling edge and output driven on the falling edge.
4. Input sampled on the falling edge and output driven on the rising edge.

Figure 5. SCC/SMC/SPI/I<sup>2</sup>C External Clock Diagram

Figure 6 shows the SCC/SMC/SPI/I<sup>2</sup>C internal clock.

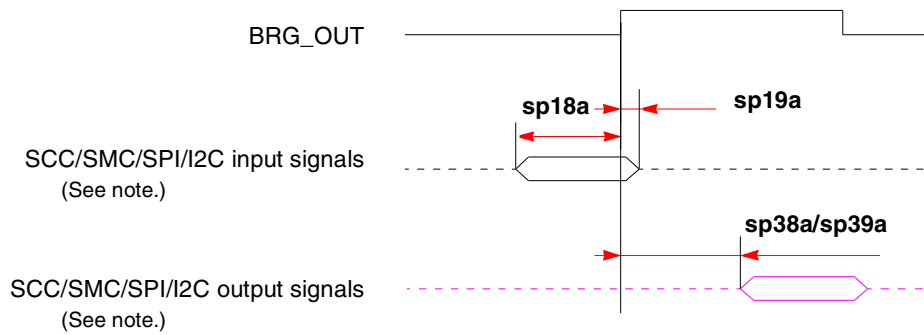

**Note:** There are four possible timing conditions for SCC and SPI:

1. Input sampled on the rising edge and output driven on the rising edge (shown).
2. Input sampled on the rising edge and output driven on the falling edge.
3. Input sampled on the falling edge and output driven on the falling edge.
4. Input sampled on the falling edge and output driven on the rising edge.

**Figure 6. SCC/SMC/SPI/I<sup>2</sup>C Internal Clock Diagram**

Figure 7 shows TDM input and output signals.

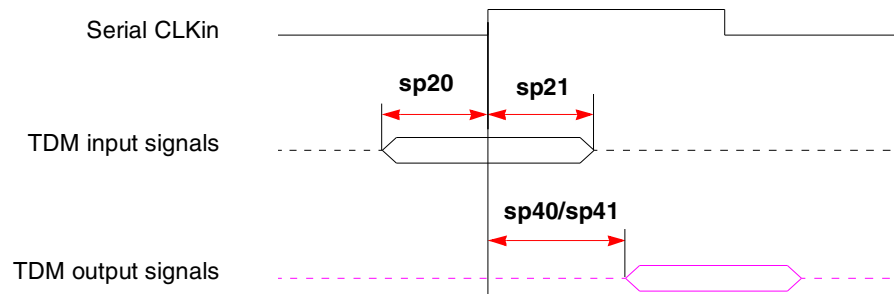

**Note:** There are four possible TDM timing conditions:

1. Input sampled on the rising edge and output driven on the rising edge (shown).
2. Input sampled on the rising edge and output driven on the falling edge.
3. Input sampled on the falling edge and output driven on the falling edge.
4. Input sampled on the falling edge and output driven on the rising edge.

**Figure 7. TDM Signal Diagram**

Figure 8 shows PIO, timer, and DMA signals.

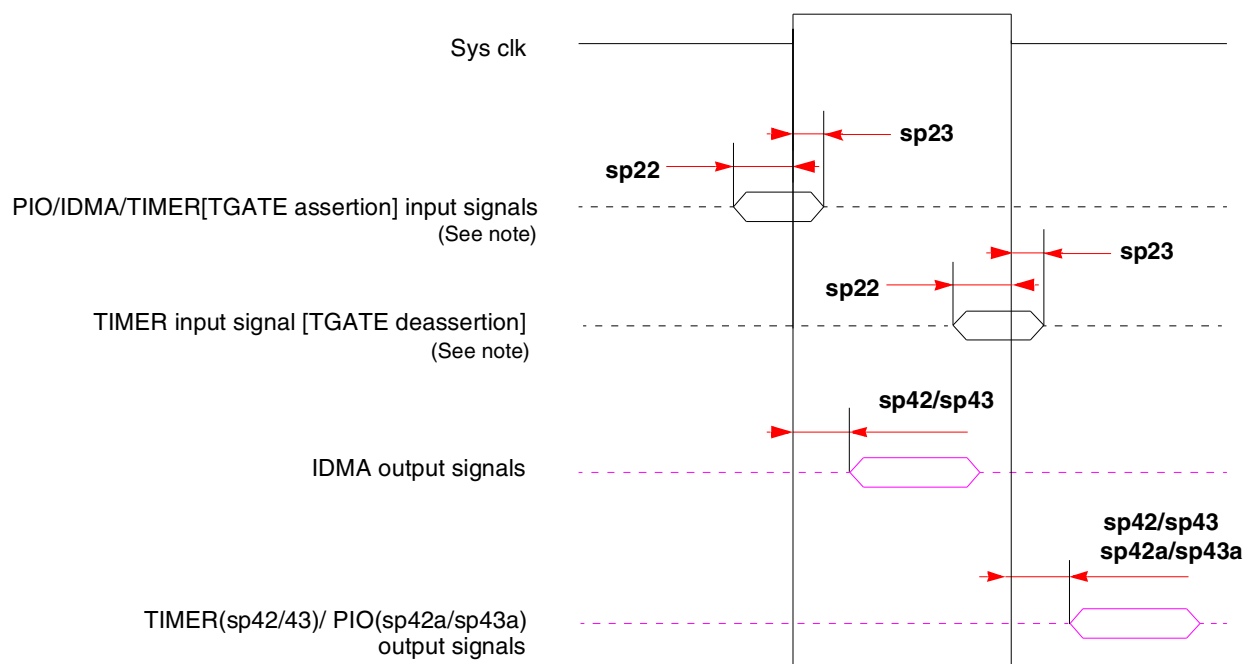

**Note:** TGATE is asserted on the rising edge of the clock; it is deasserted on the falling edge.

**Figure 8. PIO, Timer, and DMA Signal Diagram**

Table 10 lists SIU input characteristics.

**Table 9. AC Characteristics for SIU Inputs<sup>1</sup>**

Spec Number		Characteristic	Setup (ns)		Hold (ns)	
Max	Min		66 MHz	83 MHz	66 MHz	83 MHz
sp11	sp10	AACK/ARTRY/T $\bar{A}$ /TS/TEA/DBG/BG/BR	6	5	0.5	0.5
sp12	sp10	Data bus in normal mode	5	4	0.5	0.5
sp13	sp10	Data bus in ECC and PARITY modes	8	6	0.5	0.5
sp14	sp10	DP pins	7	6	0.5	0.5
sp15	sp10	All other pins	5	4	0.5	0.5

<sup>1</sup> Input specifications are measured from the 50% level of the signal to the 50% level of the rising edge of CLKIN. Timings are measured at the pin.

Table 10 lists SIU output characteristics.

**Table 10. AC Characteristics for SIU Outputs<sup>1</sup>**

Spec Number		Characteristic	Max Delay (ns)		Min Delay (ns)	
Max	Min		66 MHz	83 MHz	66 MHz	83 MHz
sp31	sp30	PSDVAL/TEA/TA	7	6	0.5	0.5
sp32	sp30	ADD/ADD_atr./BADDR/CI/GBL/WT	8	6.5	0.5	0.5
sp33a	sp30	Data bus	6.5	6.5	0.5	0.5
sp33b	sp30	DP	8	7	0.5	0.5
sp34	sp30	Memory controller signals/ALE	6	5	0.5	0.5
sp35	sp30	All other signals	6	5.5	0.5	0.5

<sup>1</sup> Output specifications are measured from the 50% level of the rising edge of CLKIN to the 50% level of the signal. Timings are measured at the pin.

**NOTE**

Activating data pipelining (setting BR<sub>x</sub>[DR] in the memory controller) improves the AC timing. When data pipelining is activated, sp12 can be used for data bus setup even when ECC or PARITY are used. Also, sp33a can be used as the AC specification for DP signals.

Figure 9 shows the interaction of several bus signals.

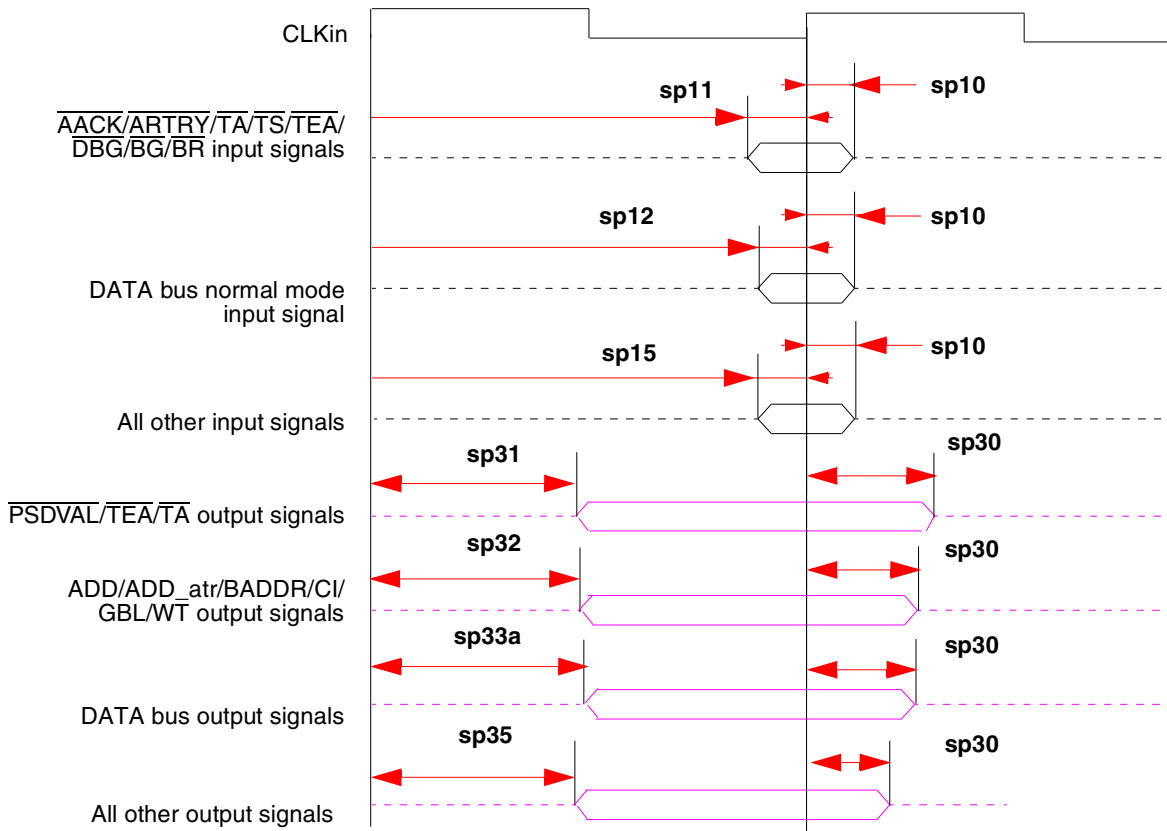

Figure 9. Bus Signals

Figure 10 shows signal behavior for all parity modes (including ECC, RMW parity, and standard parity).

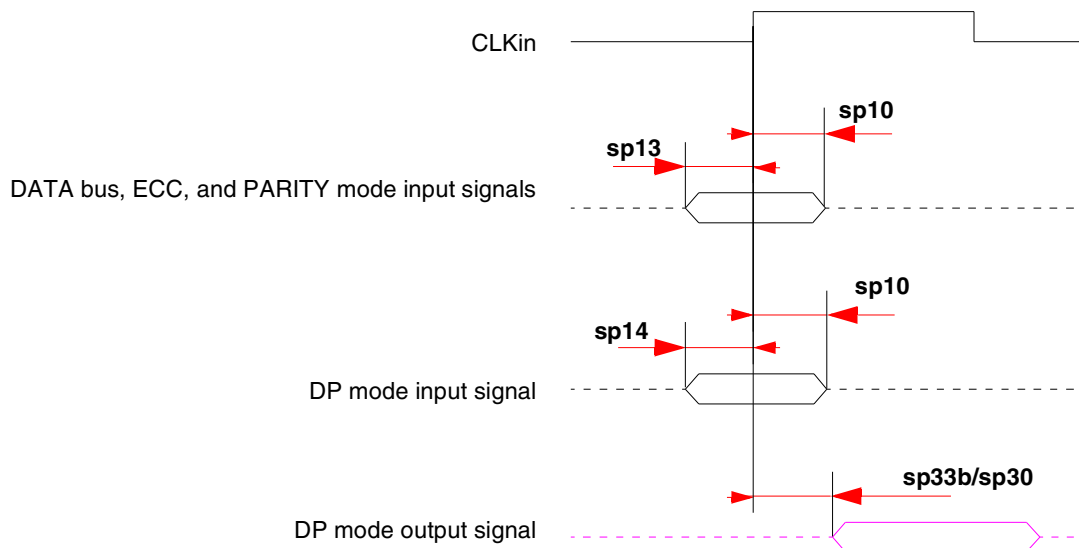

Figure 10. Parity Mode Diagram

Figure 11 shows signal behavior in MEMC mode.

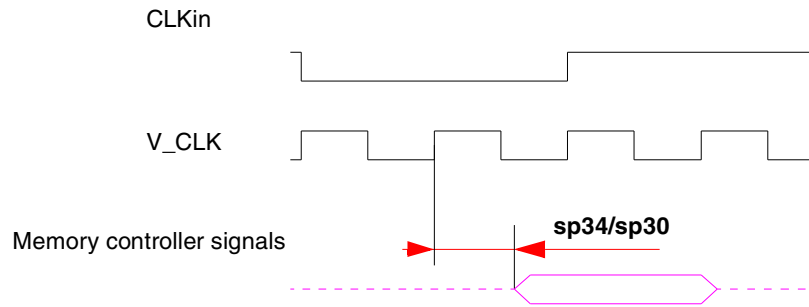

Figure 11. MEMC Mode Diagram

**NOTE**

Generally, all MPC826xA bus and system output signals are driven from the rising edge of the input clock (CLKIn). Memory controller signals, however, trigger on four points within a CLKIn cycle. Each cycle is divided by four internal ticks: T1, T2, T3, and T4. T1 always occurs at the rising edge, and T3 at the falling edge, of CLKIn. However, the spacing of T2 and T4 depends on the PLL clock ratio selected, as shown in Table 11.

Table 11. Tick Spacing for Memory Controller Signals

PLL Clock Ratio	Tick Spacing (T1 Occurs at the Rising Edge of CLKIn)		
	T2	T3	T4
1:2, 1:3, 1:4, 1:5, 1:6	1/4 CLKIn	1/2 CLKIn	3/4 CLKIn
1:2.5	3/10 CLKIn	1/2 CLKIn	8/10 CLKIn
1:3.5	4/14 CLKIn	1/2 CLKIn	11/14 CLKIn

Figure 12 is a graphical representation of Table 11.

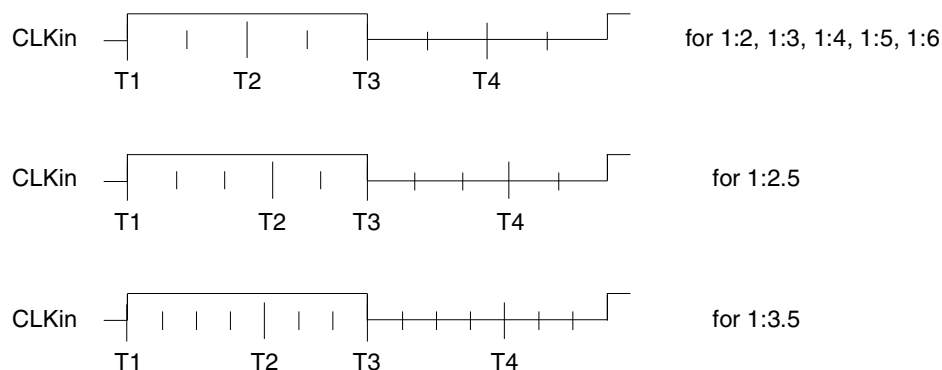

Figure 12. Internal Tick Spacing for Memory Controller Signals

Table 12 lists the JTAG timings.

**Table 12. JTAG Timings<sup>1</sup>**

Parameter	Symbol <sup>2</sup>	Min	Max	Unit	Notes	
JTAG external clock frequency of operation	$f_{JTG}$	0	25	MHz	—	
JTAG external clock cycle time	$t_{JTG}$	40	—	ns	—	
JTAG external clock pulse width measured at 1.4V	$t_{JTKHKL}$	20	—	ns	—	
JTAG external clock rise and fall times	$t_{JTGR}$ and $t_{JTGF}$	0	5	ns	6	
TRST assert time	$t_{TRST}$	25	—	ns	3, 6	
Input setup times	Boundary-scan data	$t_{JTDVKH}$	4	—	ns	4, 7
	TMS, TDI	$t_{JTIVKH}$	4	—	ns	4, 7
Input hold times	Boundary-scan data	$t_{JTDXKH}$	10	—	ns	4, 7
	TMS, TDI	$t_{JTIXKH}$	10	—	ns	4, 7
Output valid times	Boundary-scan data	$t_{JTKLDV}$	—	25	ns	5, 7
	TDO	$t_{JTKLOV}$	—	25	ns	5, 7
Output hold times	Boundary-scan data	$t_{JTKLDX}$	1	—	ns	5, 7
	TDO	$t_{JTKLOX}$	1	—	ns	5, 7
JTAG external clock to output high impedance	Boundary-scan data	$t_{JTKLDZ}$	1	25	ns	5, 6
	TDO	$t_{JTKLOZ}$	1	25	ns	5, 6

<sup>1</sup> All outputs are measured from the midpoint voltage of the falling/rising edge of  $t_{TCLK}$  to the midpoint of the signal in question. The output timings are measured at the pins. All output timings assume a purely resistive 50-Ω load. Time-of-flight delays must be added for trace lengths, vias, and connectors in the system.

<sup>2</sup> The symbols used for timing specifications herein follow the pattern of  $t_{(first\ two\ letters\ of\ functional\ block)(signal)(state)}$  (reference)(state) for inputs and  $t_{(first\ two\ letters\ of\ functional\ block)(reference)(state)(signal)(state)}$  for outputs. For example,  $t_{JTDVKH}$  symbolizes JTAG device timing (JT) with respect to the time data input signals (D) reaching the valid state (V) relative to the  $t_{JTG}$  clock reference (K) going to the high (H) state or setup time. Also,  $t_{JTDXKH}$  symbolizes JTAG timing (JT) with respect to the time data input signals (D) went invalid (X) relative to the  $t_{JTG}$  clock reference (K) going to the high (H) state. Note that, in general, the clock reference symbol representation is based on three letters representing the clock of a particular functional. For rise and fall times, the latter convention is used with the appropriate letter: R (rise) or F (fall).

<sup>3</sup> TRST is an asynchronous level sensitive signal. The setup time is for test purposes only.

<sup>4</sup> Non-JTAG signal input timing with respect to  $t_{TCLK}$ .

<sup>5</sup> Non-JTAG signal output timing with respect to  $t_{TCLK}$ .

<sup>6</sup> Guaranteed by design.

<sup>7</sup> Guaranteed by design and device characterization.

#### NOTE

The UPM machine outputs change on the internal tick determined by the memory controller programming; the AC specifications are relative to the internal tick. Note that SDRAM and GPCM machine outputs change on CLKin's rising edge.

## 3 Clock Configuration Modes

To configure the main PLL multiplication factor and the core, CPM, and 60x bus frequencies, the MODCK[1–3] pins are sampled while  $\overline{\text{HRESET}}$  is asserted. Table 13 lists the eight basic configuration modes. Table 14 lists the other modes that are available by using the configuration pin (RSTCONF) and driving four bits from hardware configuration word on the data bus.

Note that the MPC8265 and the MPC8266 have two additional clocking modes—PCI agent and PCI host. Refer to Section 3.2, “PCI Mode” on page 26 for information.

### NOTE

Clock configurations change only after  $\overline{\text{POR}}$  is asserted.

### 3.1 Local Bus Mode

Table 13 describes default clock modes for the MPC826xA.

**Table 13. Clock Default Modes**

MODCK[1–3]	Input Clock Frequency	CPM Multiplication Factor	CPM Frequency	Core Multiplication Factor	Core Frequency
000	33 MHz	3	100 MHz	4	133 MHz
001	33 MHz	3	100 MHz	5	166 MHz
010	33 MHz	4	133 MHz	4	133 MHz
011	33 MHz	4	133 MHz	5	166 MHz
100	66 MHz	2	133 MHz	2.5	166 MHz
101	66 MHz	2	133 MHz	3	200 MHz
110	66 MHz	2.5	166 MHz	2.5	166 MHz
111	66 MHz	2.5	166 MHz	3	200 MHz

Table 14 describes all possible clock configurations when using the hard reset configuration sequence. Note that basic modes are shown in boldface type. The frequencies listed are for the purpose of illustration only. Users must select a mode and input bus frequency so that the resulting configuration does not exceed the frequency rating of the user’s device.

**Table 14. Clock Configuration Modes<sup>1</sup>**

MODCK_H–MODCK[1–3]	Input Clock Frequency <sup>2,3</sup>	CPM Multiplication Factor <sup>2</sup>	CPM Frequency <sup>2</sup>	Core Multiplication Factor <sup>2</sup>	Core Frequency <sup>2</sup>
0001_000	33 MHz	2	66 MHz	4	133 MHz
0001_001	33 MHz	2	66 MHz	5	166 MHz
0001_010	33 MHz	2	66 MHz	6	200 MHz
0001_011	33 MHz	2	66 MHz	7	233 MHz
0001_100	33 MHz	2	66 MHz	8	266 MHz

**Table 14. Clock Configuration Modes<sup>1</sup> (continued)**

MODCK_H–MODCK[1–3]	Input Clock Frequency <sup>2,3</sup>	CPM Multiplication Factor <sup>2</sup>	CPM Frequency <sup>2</sup>	Core Multiplication Factor <sup>2</sup>	Core Frequency <sup>2</sup>
0001_101	33 MHz	3	100 MHz	4	133 MHz
0001_110	33 MHz	3	100 MHz	5	166 MHz
0001_111	33 MHz	3	100 MHz	6	200 MHz
0010_000	33 MHz	3	100 MHz	7	233 MHz
0010_001	33 MHz	3	100 MHz	8	266 MHz
0010_010	<b>33 MHz</b>	<b>4</b>	<b>133 MHz</b>	<b>4</b>	<b>133 MHz</b>
0010_011	<b>33 MHz</b>	<b>4</b>	<b>133 MHz</b>	<b>5</b>	<b>166 MHz</b>
0010_100	33 MHz	4	133 MHz	6	200 MHz
0010_101	33 MHz	4	133 MHz	7	233 MHz
0010_110	33 MHz	4	133 MHz	8	266 MHz
0010_111	33 MHz	5	166 MHz	4	133 MHz
0011_000	33 MHz	5	166 MHz	5	166 MHz
0011_001	33 MHz	5	166 MHz	6	200 MHz
0011_010	33 MHz	5	166 MHz	7	233 MHz
0011_011	33 MHz	5	166 MHz	8	266 MHz
0011_100	33 MHz	6	200 MHz	4	133 MHz
0011_101	33 MHz	6	200 MHz	5	166 MHz
0011_110	33 MHz	6	200 MHz	6	200 MHz
0011_111	33 MHz	6	200 MHz	7	233 MHz
0100_000	33 MHz	6	200 MHz	8	266 MHz
0100_001	Reserved				
0100_010					
0100_011					
0100_100					
0100_101					
0100_110					

Table 14. Clock Configuration Modes<sup>1</sup> (continued)

MODCK_H–MODCK[1–3]	Input Clock Frequency <sup>2,3</sup>	CPM Multiplication Factor <sup>2</sup>	CPM Frequency <sup>2</sup>	Core Multiplication Factor <sup>2</sup>	Core Frequency <sup>2</sup>
0100_111	Reserved				
0101_000					
0101_001					
0101_010					
0101_011					
0101_100					
0101_101	66 MHz	2	133 MHz	2	133 MHz
0101_110	<b>66 MHz</b>	<b>2</b>	<b>133 MHz</b>	<b>2.5</b>	<b>166 MHz</b>
0101_111	<b>66 MHz</b>	<b>2</b>	<b>133 MHz</b>	<b>3</b>	<b>200 MHz</b>
0110_000	66 MHz	2	133 MHz	3.5	233 MHz
0110_001	66 MHz	2	133 MHz	4	266 MHz
0110_010	66 MHz	2	133 MHz	4.5	300 MHz
0110_011	66 MHz	2.5	166 MHz	2	133 MHz
0110_100	<b>66 MHz</b>	<b>2.5</b>	<b>166 MHz</b>	<b>2.5</b>	<b>166 MHz</b>
0110_101	<b>66 MHz</b>	<b>2.5</b>	<b>166 MHz</b>	<b>3</b>	<b>200 MHz</b>
0110_110	66 MHz	2.5	166 MHz	3.5	233 MHz
0110_111	66 MHz	2.5	166 MHz	4	266 MHz
0111_000	66 MHz	2.5	166 MHz	4.5	300 MHz
0111_001	66 MHz	3	200 MHz	2	133 MHz
0111_010	66 MHz	3	200 MHz	2.5	166 MHz
0111_011	66 MHz	3	200 MHz	3	200 MHz
0111_100	66 MHz	3	200 MHz	3.5	233 MHz
0111_101	66 MHz	3	200 MHz	4	266 MHz
0111_110	66 MHz	3	200 MHz	4.5	300 MHz
0111_111	66 MHz	3.5	233 MHz	2	133 MHz
1000_000	66 MHz	3.5	233 MHz	2.5	166 MHz

**Table 14. Clock Configuration Modes<sup>1</sup> (continued)**

MODCK_H–MODCK[1–3]	Input Clock Frequency <sup>2,3</sup>	CPM Multiplication Factor <sup>2</sup>	CPM Frequency <sup>2</sup>	Core Multiplication Factor <sup>2</sup>	Core Frequency <sup>2</sup>
1000_001	66 MHz	3.5	233 MHz	3	200 MHz
1000_010	66 MHz	3.5	233 MHz	3.5	233 MHz
1000_011	66 MHz	3.5	233 MHz	4	266 MHz
1000_100	66 MHz	3.5	233 MHz	4.5	300 MHz

<sup>1</sup> Because of speed dependencies, not all of the possible configurations in Table 14 are applicable.

<sup>2</sup> The user should choose the input clock frequency and the multiplication factors such that the frequency of the CPU is equal to or greater than 150 MHz and the CPM ranges between 66–233 MHz.

<sup>3</sup> Input clock frequency is given only for the purpose of reference. The user should set MODCK\_H–MODCK\_L so that the resulting configuration does not exceed the frequency rating of the user’s part.

### 3.2 PCI Mode

The MPC8265 and the MPC8266 have three clocking modes: local, PCI host, and PCI agent. The clocking mode is set according to three input pins—PCI\_MODE, PCI\_CFG[0], PCI\_MODCK—as shown in Table 15.

**Table 15. MPC8265 and MPC8266 Clocking Modes**

Pins			Clocking Mode	PCI Clock Frequency Range (MHZ)
PCI_MODE	PCI_CFG[0]	PCI_MODCK		
1	—	—	Local bus	—
0	0	0	PCI host	50–66
0	0	1		25–50
0	1	0	PCI agent	50–66
0	1	1		25–50

In addition, note the following:

**NOTE: PCI\_MODCK**

In PCI mode only, PCI\_MODCK comes from the LGPL5 pin and MODCK\_H[0–3] comes from {LGPL0, LGPL1, LGPL2, LGPL3}.

**NOTE: Tval (Output Hold)**

The minimum Tval = 2 when PCI\_MODCK = 1, and the minimum Tval = 1 when PCI\_MODCK = 0. Therefore, designers should use clock configurations that fit this condition to achieve PCI-compliant AC timing.

**NOTE**

Clock configurations change only after  $\overline{\text{POR}}$  is asserted.

### 3.2.1 PCI Host Mode

The frequencies listed in [Table 16](#) and [Table 17](#) are for the purpose of illustration only. Users must select a mode and input bus frequency so that the resulting configuration does not exceed the frequency rating of the user's device.

**Table 16. Clock Default Configurations in PCI Host Mode (MODCK\_HI = 0000)**

MODCK[1–3] <sup>1</sup>	Input Clock Frequency (Bus)	CPM Multiplication Factor	CPM Frequency	Core Multiplication Factor	Core Frequency	PCI Division Factor <sup>2</sup>	PCI Frequency <sup>2</sup>
000	66 MHz	2	133 MHz	2.5	166 MHz	2/4	66/33 MHz
001	66 MHz	2	133 MHz	3	200 MHz	2/4	66/33 MHz
010	66 MHz	2.5	166 MHz	3	200 MHz	3/6	55/28 MHz
011	66 MHz	2.5	166 MHz	3.5	233 MHz	3/6	55/28 MHz
100	66 MHz	2.5	166 MHz	4	266 MHz	3/6	55/28 MHz
101	66 MHz	3	200 MHz	3	200 MHz	3/6	66/33 MHz
110	66 MHz	3	200 MHz	3.5	233 MHz	3/6	66/33 MHz
111	66 MHz	3	200 MHz	4	266 MHz	3/6	66/33 MHz

<sup>1</sup> Assumes MODCK\_HI = 0000.

<sup>2</sup> The frequency depends on the value of PCI\_MODCK. If PCI\_MODCK is high (logic '1'), the PCI frequency is divided by 2 (33 instead of 66 MHz, etc.) Refer to [Table 15](#).

[Table 17](#) describes all possible clock configurations when using the MPC8265's or the MPC8266's internal PCI bridge in host mode.

**Table 17. Clock Configuration Modes in PCI Host Mode**

MODCK_H – MODCK[1–3]	Input Clock Frequency <sup>1</sup> (Bus)	CPM Multiplication Factor	CPM Frequency	Core Multiplication Factor	Core Frequency	PCI Division Factor <sup>2</sup>	PCI Frequency <sup>2</sup>
0001_000	33 MHz	3	100 MHz	5	166 MHz	3/6	33/16 MHz
0001_001	33 MHz	3	100 MHz	6	200 MHz	3/6	33/16 MHz
0001_010	33 MHz	3	100 MHz	7	233 MHz	3/6	33/16 MHz
0001_011	33 MHz	3	100 MHz	8	266 MHz	3/6	33/16 MHz
0010_000	<b>33 MHz</b>	<b>4</b>	<b>133 MHz</b>	<b>5</b>	<b>166 MHz</b>	<b>4/8</b>	<b>33/16 MHz</b>
0010_001	33 MHz	4	133 MHz	6	200 MHz	4/8	33/16 MHz
0010_010	33 MHz	4	133 MHz	7	233 MHz	4/8	33/16 MHz
0010_011	33 MHz	4	133 MHz	8	266 MHz	4/8	33/16 MHz
0011_000 <sup>3</sup>	33 MHz	5	166 MHz	5	166 MHz	5	<b>33 MHz</b>
0011_001 <sup>3</sup>	33 MHz	5	166 MHz	6	200 MHz	5	33 MHz
0011_010 <sup>3</sup>	33 MHz	5	166 MHz	7	233 MHz	5	33 MHz

**Table 17. Clock Configuration Modes in PCI Host Mode (continued)**

<b>MODCK_H – MODCK[1–3]</b>	<b>Input Clock Frequency<sup>1</sup> (Bus)</b>	<b>CPM Multiplication Factor</b>	<b>CPM Frequency</b>	<b>Core Multiplication Factor</b>	<b>Core Frequency</b>	<b>PCI Division Factor<sup>2</sup></b>	<b>PCI Frequency<sup>2</sup></b>
0011_011 <sup>3</sup>	33 MHz	5	166 MHz	8	266 MHz	5	33 MHz
0100_000 <sup>3</sup>	33 MHz	6	200 MHz	5	166 MHz	6	33 MHz
0100_001 <sup>3</sup>	33 MHz	6	200 MHz	6	200 MHz	6	33 MHz
0100_010 <sup>3</sup>	33 MHz	6	200 MHz	7	233 MHz	6	33 MHz
0100_011 <sup>3</sup>	33 MHz	6	200 MHz	8	266 MHz	6	33 MHz
0101_000	<b>66 MHz</b>	<b>2</b>	<b>133 MHz</b>	<b>2.5</b>	<b>166 MHz</b>	<b>2/4</b>	<b>66/33 MHz</b>
0101_001	<b>66 MHz</b>	<b>2</b>	<b>133 MHz</b>	<b>3</b>	<b>200 MHz</b>	<b>2/4</b>	<b>66/33 MHz</b>
0101_010	66 MHz	2	133 MHz	3.5	233 MHz	2/4	66/33 MHz
0101_011	66 MHz	2	133 MHz	4	266 MHz	2/4	66/33 MHz
0101_100	66 MHz	2	133 MHz	4.5	300 MHz	2/4	66/33 MHz
0110_000	<b>66 MHz</b>	<b>2.5</b>	<b>166 MHz</b>	<b>2.5</b>	<b>166 MHz</b>	<b>3/6</b>	<b>55/28 MHz</b>
0110_001	<b>66 MHz</b>	<b>2.5</b>	<b>166 MHz</b>	<b>3</b>	<b>200 MHz</b>	<b>3/6</b>	<b>55/28 MHz</b>
0110_010	66 MHz	2.5	166 MHz	3.5	233 MHz	3/6	55/28 MHz
0110_011	66 MHz	2.5	166 MHz	4	266 MHz	3/6	55/28 MHz
0110_100	66 MHz	2.5	166 MHz	4.5	300 MHz	3/6	55/28 MHz
0111_000	66 MHz	3	200 MHz	2.5	166 MHz	3/6	66/33 MHz
0111_001	66 MHz	3	200 MHz	3	200 MHz	3/6	66/33 MHz
0111_010	66 MHz	3	200 MHz	3.5	233 MHz	3/6	66/33 MHz
0111_011	66 MHz	3	200 MHz	4	266 MHz	3/6	66/33 MHz
0111_100	66 MHz	3	200 MHz	4.5	300 MHz	3/6	66/33 MHz
1000_000	66 MHz	3	200 MHz	2.5	166 MHz	4/8	50/25 MHz
1000_001	66 MHz	3	200 MHz	3	200 MHz	4/8	50/25 MHz
1000_010	66 MHz	3	200 MHz	3.5	233 MHz	4/8	50/25 MHz
1000_011	66 MHz	3	200 MHz	4	266 MHz	4/8	50/25 MHz
1000_100	66 MHz	3	200 MHz	4.5	300 MHz	4/8	50/25 MHz
1001_000	66 MHz	3.5	233 MHz	2.5	166 MHz	4/8	58/29 MHz
1001_001	66 MHz	3.5	233 MHz	3	200 MHz	4/8	58/29 MHz

**Table 17. Clock Configuration Modes in PCI Host Mode (continued)**

MODCK_H – MODCK[1–3]	Input Clock Frequency <sup>1</sup> (Bus)	CPM Multiplication Factor	CPM Frequency	Core Multiplication Factor	Core Frequency	PCI Division Factor <sup>2</sup>	PCI Frequency <sup>2</sup>
1001_010	66 MHz	3.5	233 MHz	3.5	233 MHz	4/8	58/29 MHz
1001_011	66 MHz	3.5	233 MHz	4	266 MHz	4/8	58/29 MHz
1001_100	66 MHz	3.5	233 MHz	4.5	300 MHz	4/8	58/29 MHz
1010_000	100 MHz	2	200 MHz	2	200 MHz	3/6	66/33 MHz
1010_001	100 MHz	2	200 MHz	2.5	250 MHz	3/6	66/33 MHz
1010_010	100 MHz	2	200 MHz	3	300 MHz	3/6	66/33 MHz
1010_011	100 MHz	2	200 MHz	3.5	350 MHz	3/6	66/33 MHz
1010_100	100 MHz	2	200 MHz	4	400 MHz	3/6	66/33 MHz
1011_000	100 MHz	2.5	250 MHz	2	200 MHz	4/8	62/31 MHz
1011_001	100 MHz	2.5	250 MHz	2.5	250 MHz	4/8	62/31MHz
1011_010	100 MHz	2.5	250 MHz	3	300 MHz	4/8	62/31 MHz
1011_011	100 MHz	2.5	250 MHz	3.5	350 MHz	4/8	62/31 MHz
1011_100	100 MHz	2.5	250 MHz	4	400 MHz	4/8	62/31 MHz

<sup>1</sup> Input clock frequency is given only for the purpose of reference. User should set MODCK\_H–MODCK\_L so that the resulting configuration does not exceed the frequency rating of the user's part.

<sup>2</sup> The frequency depends on the value of PCI\_MODCK. If PCI\_MODCK is high (logic '1'), the PCI frequency is divided by 2 (33 instead of 66 MHz, etc.). Refer to [Table 15](#).

<sup>3</sup> In this mode, PCI\_MODCK must be "0".

### 3.2.2 PCI Agent Mode

The frequencies listed in [Table 18](#) and [Table 19](#) are for the purpose of illustration only. Users must select a mode and input bus frequency so that the resulting configuration does not exceed the frequency rating of the user's device.

**Table 18. Clock Default Configurations in PCI Agent Mode (MODCK\_HI = 0000)**

MODCK[1–3] <sup>1</sup>	Input Clock Frequency (PCI) <sup>2</sup>	CPM Multiplication Factor <sup>2</sup>	CPM Frequency	Core Multiplication Factor	Core Frequency <sup>3</sup>	Bus Division Factor	60x Bus Frequency <sup>4</sup>
000	66/33 MHz	2/4	133 MHz	2.5	166 MHz	2	66 MHz
001	66/33 MHz	2/4	133 MHz	3	200 MHz	2	66 MHz
010	66/33 MHz	3/6	200 MHz	3	200 MHz	3	66 MHz
011	66/33 MHz	3/6	200 MHz	4	266 MHz	3	66 MHz

**Table 18. Clock Default Configurations in PCI Agent Mode (MODCK\_HI = 0000) (continued)**

MODCK[1-3] <sup>1</sup>	Input Clock Frequency (PCI) <sup>2</sup>	CPM Multiplication Factor <sup>2</sup>	CPM Frequency	Core Multiplication Factor	Core Frequency <sup>3</sup>	Bus Division Factor	60x Bus Frequency <sup>4</sup>
100	66/33 MHz	3/6	200 MHz	3	240 MHz	2.5	80 MHz
101	66/33 MHz	3/6	200 MHz	3.5	280 MHz	2.5	80 MHz
110	66/33 MHz	4/8	266 MHz	3.5	300 MHz	3	88 MHz
111	66/33 MHz	4/8	266 MHz	3	300 MHz	2.5	100 MHz

<sup>1</sup> Assumes MODCK\_HI = 0000.

<sup>2</sup> The frequency depends on the value of PCI\_MODCK. If PCI\_MODCK is high (logic '1'), the PCI frequency is divided by 2 (33 instead of 66 MHz, etc.) and the CPM multiplication factor is multiplied by 2. Refer to [Table 15](#).

<sup>3</sup> Core frequency = (60x bus frequency)(core multiplication factor)

<sup>4</sup> Bus frequency = CPM frequency/bus division factor

[Table 19](#) describes all possible clock configurations when using the MPC8265 or the MPC8266's internal PCI bridge in agent mode.

**Table 19. Clock Configuration Modes in PCI Agent Mode**

MODCK_H – MODCK[1-3]	Input Clock Frequency (PCI) <sup>1,2</sup>	CPM Multiplication Factor <sup>1</sup>	CPM Frequency	Core Multiplication Factor	Core Frequency <sup>3</sup>	Bus Division Factor	60x Bus Frequency <sup>4</sup>
0001_001	66/33 MHz	2/4	133 MHz	5	166 MHz	4	33 MHz
0001_010	66/33 MHz	2/4	133 MHz	6	200 MHz	4	33 MHz
0001_011	66/33 MHz	2/4	133 MHz	7	233 MHz	4	33 MHz
0001_100	66/33 MHz	2/4	133 MHz	8	266 MHz	4	33 MHz
0010_001	50/25 MHz	3/6	<b>150 MHz</b>	3	180 MHz	2.5	<b>60 MHz</b>
0010_010	50/25 MHz	3/6	<b>150 MHz</b>	3.5	210 MHz	2.5	<b>60 MHz</b>
0010_011	50/25 MHz	3/6	<b>150 MHz</b>	4	240 MHz	2.5	<b>60 MHz</b>
0010_100	50/25 MHz	3/6	<b>150 MHz</b>	4.5	270 MHz	2.5	<b>60 MHz</b>
0011_000	66/33 MHz	2/4	<b>133 MHz</b>	2.5	110MHz	3	44 MHz
0011_001	66/33 MHz	2/4	<b>133 MHz</b>	3	132 MHz	3	44 MHz
0011_010	66/33 MHz	2/4	<b>133 MHz</b>	3.5	154 MHz	3	<b>44 MHz</b>
0011_011	66/33 MHz	2/4	<b>133 MHz</b>	4	176MHz	3	<b>44 MHz</b>
0011_100	66/33 MHz	2/4	<b>133 MHz</b>	4.5	198 MHz	3	<b>44 MHz</b>
0100_000	66/33 MHz	3/6	200 MHz	2.5	166 MHz	<b>3</b>	66 MHz
0100_001	66/33 MHz	3/6	<b>200 MHz</b>	3	200 MHz	<b>3</b>	<b>66 MHz</b>
0100_010	66/33 MHz	3/6	<b>200 MHz</b>	3.5	233 MHz	<b>3</b>	<b>66 MHz</b>
0100_011	66/33 MHz	3/6	<b>200 MHz</b>	4	266 MHz	<b>3</b>	<b>66 MHz</b>

**Table 19. Clock Configuration Modes in PCI Agent Mode (continued)**

MODCK_H – MODCK[1–3]	Input Clock Frequency (PCI) <sup>1,2</sup>	CPM Multiplication Factor <sup>1</sup>	CPM Frequency	Core Multiplication Factor	Core Frequency <sup>3</sup>	Bus Division Factor	60x Bus Frequency <sup>4</sup>
0100_100	66/33 MHz	3/6	<b>200 MHz</b>	4.5	300 MHz	<b>3</b>	<b>66 MHz</b>
0101_000 <sup>5</sup>	33 MHz	5	166 MHz	2.5	166 MHz	2.5	<b>66 MHz</b>
0101_001 <sup>5</sup>	33 MHz	5	166 MHz	3	200 MHz	2.5	66 MHz
0101_010 <sup>5</sup>	33 MHz	5	166 MHz	3.5	233 MHz	2.5	66 MHz
0101_011 <sup>5</sup>	33 MHz	5	166 MHz	4	266 MHz	2.5	66 MHz
0101_100 <sup>5</sup>	33 MHz	5	166 MHz	4.5	300 MHz	2.5	66 MHz
0110_000	50/25 MHz	4/8	200 MHz	2.5	166 MHz	3	66 MHz
0110_001	50/25 MHz	4/8	200 MHz	3	200 MHz	3	66 MHz
0110_010	50/25 MHz	4/8	200 MHz	3.5	233 MHz	3	66 MHz
0110_011	50/25 MHz	4/8	200 MHz	4	266 MHz	3	66 MHz
0110_100	50/25 MHz	4/8	200 MHz	4.5	300 MHz	3	66 MHz
0111_000	66/33 MHz	3/6	200 MHz	2	200 MHz	2	100 MHz
0111_001	66/33 MHz	3/6	200 MHz	2.5	250 MHz	2	100 MHz
0111_010	66/33 MHz	3/6	200 MHz	3	300 MHz	2	100 MHz
0111_011	66/33 MHz	3/6	200 MHz	3.5	350 MHz	2	100 MHz
1000_000	66/33 MHz	3/6	200 MHz	2	160 MHz	2.5	80 MHz
1000_001	66/33 MHz	3/6	200 MHz	2.5	200 MHz	2.5	80 MHz
1000_010	66/33 MHz	3/6	200 MHz	3	240 MHz	2.5	80 MHz
1000_011	66/33 MHz	3/6	200 MHz	3.5	280 MHz	2.5	80 MHz
1000_100	66/33 MHz	3/6	200 MHz	4	320 MHz	2.5	80 MHz
1000_101	66/33 MHz	3/6	200 MHz	4.5	360 MHz	2.5	80 MHz
1001_000	66/33 MHz	4/8	266 MHz	2.5	166 MHz	4	66 MHz
1001_001	66/33 MHz	4/8	266 MHz	3	200 MHz	4	66 MHz
1001_010	66/33 MHz	4/8	266 MHz	3.5	233 MHz	4	66 MHz
1001_011	66/33 MHz	4/8	266 MHz	4	266 MHz	4	66 MHz
1001_100	66/33 MHz	4/8	266 MHz	4.5	300 MHz	4	66 MHz
1010_000	66/33 MHz	4/8	266 MHz	2.5	222 MHz	3	88 MHz

**Table 19. Clock Configuration Modes in PCI Agent Mode (continued)**

MODCK_H – MODCK[1–3]	Input Clock Frequency (PCI) <sup>1,2</sup>	CPM Multiplication Factor <sup>1</sup>	CPM Frequency	Core Multiplication Factor	Core Frequency <sup>3</sup>	Bus Division Factor	60x Bus Frequency <sup>4</sup>
1010_001	66/33 MHz	4/8	266 MHz	3	266 MHz	3	88 MHz
1010_010	66/33 MHz	4/8	266 MHz	3.5	300 MHz	3	88 MHz
1010_011	66/33 MHz	4/8	266 MHz	4	350 MHz	3	88 MHz
1010_100	66/33 MHz	4/8	266 MHz	4.5	400 MHz	3	88 MHz
1011_000	66/33 MHz	4/8	266 MHz	2	212MHz	2.5	106 MHz
1011_001	66/33 MHz	4/8	266 MHz	2.5	265 MHz	2.5	106 MHz
1011_010	66/33 MHz	4/8	266 MHz	3	318 MHz	2.5	106 MHz
1011_011	66/33 MHz	4/8	266 MHz	3.5	371 MHz	2.5	106 MHz
1011_100	66/33 MHz	4/8	266 MHz	4	424 MHz	2.5	106 MHz

<sup>1</sup> The frequency depends on the value of PCI\_MODCK. If PCI\_MODCK is high (logic '1'), the PCI frequency is divided by 2 (33 instead of 66 MHz, etc.) and the CPM multiplication factor is multiplied by 2. Refer to [Table 15](#).

<sup>2</sup> Input clock frequency is given only for the purpose of reference. User should set MODCK\_H–MODCK\_L so that the resulting configuration does not exceed the frequency rating of the user's part.

<sup>3</sup> Core frequency = (60x bus frequency)(core multiplication factor)

<sup>4</sup> Bus frequency = CPM frequency/bus division factor

<sup>5</sup> In this mode, PCI\_MODCK must be "1".

## 4 Pinout

This section provides the pin assignments and pinout list for the MPC826xA.

### 4.1 Pin Assignments

Figure 13 shows the pinout of the MPC826xA's 480 TBGA package as viewed from the top surface.

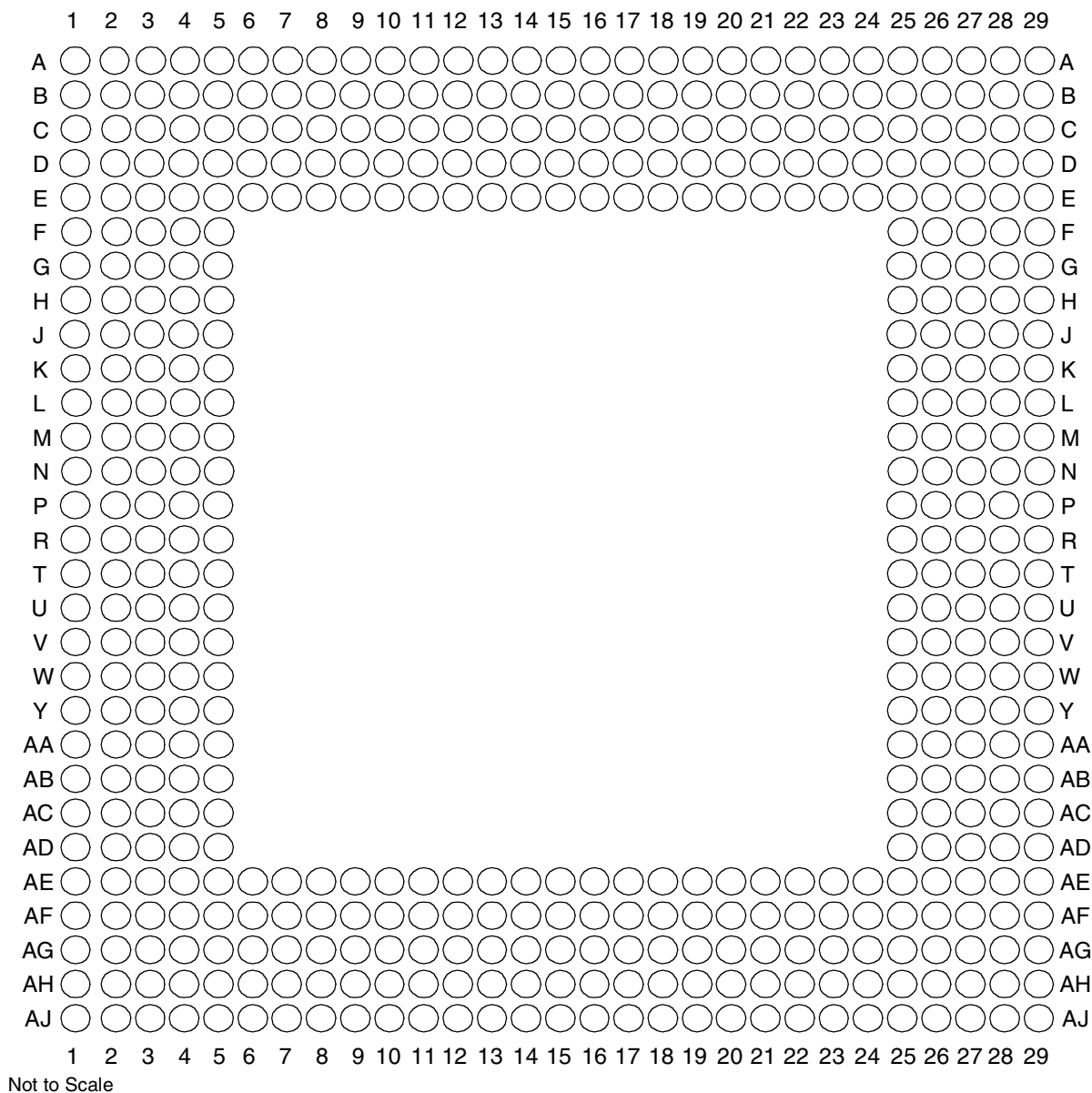

Figure 13. Pinout of the 480 TBGA Package as Viewed from the Top Surface

Figure 14 shows the side profile of the TBGA package to indicate the direction of the top surface view.

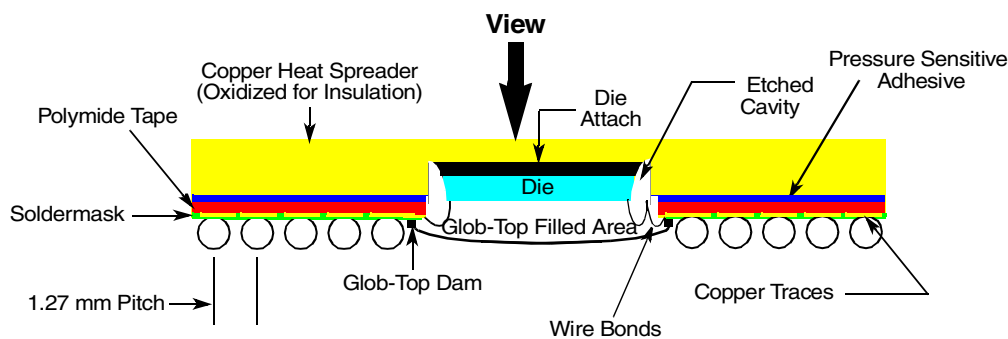

Figure 14. Side View of the TBGA Package

Table 21 shows the pinout list of the MPC826xA. Table 20 defines conventions and acronyms used in Table 21.

Symbols used in Table 21 are described in Table 20.

Table 20. Symbol Legend

Symbol	Meaning
OVERBAR	Signals with overbars, such as $\overline{TA}$ , are active low.
UTM	Indicates that a signal is part of the UTOPIA master interface.
UTS	Indicates that a signal is part of the UTOPIA slave interface.
UT8	Indicates that a signal is part of the 8-bit UTOPIA interface.
UT16	Indicates that a signal is part of the 16-bit UTOPIA interface.
MII	Indicates that a signal is part of the media independent interface.

Table 21. Pinout List

Pin Name	Ball
BR	W5
BG	F4
ABB/IRQ2	E2
TS	E3
A0	G1
A1	H5
A2	H2
A3	H1
A4	J5
A5	J4
A6	J3
A7	J2

**Table 21. Pinout List (continued)**

Pin Name	Ball
A8	J1
A9	K4
A10	K3
A11	K2
A12	K1
A13	L5
A14	L4
A15	L3
A16	L2
A17	L1
A18	M5
A19	N5
A20	N4
A21	N3
A22	N2
A23	N1
A24	P4
A25	P3
A26	P2
A27	P1
A28	R1
A29	R3
A30	R5
A31	R4
TT0	F1
TT1	G4
TT2	G3
TT3	G2
TT4	F2
TBST	D3
TSIZ0	C1
TSIZ1	E4
TSIZ2	D2
TSIZ3	F5
AACK	F3

**Table 21. Pinout List (continued)**

Pin Name	Ball
ARTRY	E1
DBG	V1
DBB/IRQ3	V2
D0	B20
D1	A18
D2	A16
D3	A13
D4	E12
D5	D9
D6	A6
D7	B5
D8	A20
D9	E17
D10	B15
D11	B13
D12	A11
D13	E9
D14	B7
D15	B4
D16	D19
D17	D17
D18	D15
D19	C13
D20	B11
D21	A8
D22	A5
D23	C5
D24	C19
D25	C17
D26	C15
D27	D13
D28	C11
D29	B8
D30	A4
D31	E6

**Table 21. Pinout List (continued)**

Pin Name	Ball
D32	E18
D33	B17
D34	A15
D35	A12
D36	D11
D37	C8
D38	E7
D39	A3
D40	D18
D41	A17
D42	A14
D43	B12
D44	A10
D45	D8
D46	B6
D47	C4
D48	C18
D49	E16
D50	B14
D51	C12
D52	B10
D53	A7
D54	C6
D55	D5
D56	B18
D57	B16
D58	E14
D59	D12
D60	C10
D61	E8
D62	D6
D63	C2
DP0/RSRV/EXT_BR2	B22
IRQ1/DP1/EXT_BG2	A22
IRQ2/DP2/TLBISYNC/EXT_DBG2	E21

**Table 21. Pinout List (continued)**

Pin Name	Ball
$\overline{\text{IRQ3}}/\text{DP3}/\overline{\text{CKSTP\_OUT}}/\overline{\text{EXT\_BR3}}$	D21
$\overline{\text{IRQ4}}/\text{DP4}/\overline{\text{CORE\_SRESET}}/\overline{\text{EXT\_BG3}}$	C21
$\overline{\text{IRQ5}}/\text{DP5}/\overline{\text{TBEN}}/\overline{\text{EXT\_DBG3}}$	B21
$\overline{\text{IRQ6}}/\text{DP6}/\text{CSE0}$	A21
$\overline{\text{IRQ7}}/\text{DP7}/\text{CSE1}$	E20
PSDVAL	V3
TA	C22
TEA	V5
GBL/IRQ1	W1
$\overline{\text{CI}}/\text{BADDR29}/\overline{\text{IRQ2}}$	U2
$\overline{\text{WT}}/\text{BADDR30}/\overline{\text{IRQ3}}$	U3
L2_HIT/IRQ4	Y4
$\overline{\text{CPU\_BG}}/\text{BADDR31}/\overline{\text{IRQ5}}$	U4
CPU_DBG	R2
CPU_BR	Y3
CS0	F25
CS1	C29
CS2	E27
CS3	E28
CS4	F26
CS5	F27
CS6	F28
CS7	G25
CS8	D29
CS9	E29
$\overline{\text{CS10}}/\overline{\text{BCTL1}}$	F29
$\overline{\text{CS11}}/\text{AP0}$	G28
BADDR27	T5
BADDR28	U1
ALE	T2
BCTL0	A27
PWE0/PSDDQM0/PBS0	C25
PWE1/PSDDQM1/PBS1	E24
PWE2/PSDDQM2/PBS2	D24
PWE3/PSDDQM3/PBS3	C24

Table 21. Pinout List (continued)

Pin Name	Ball
PWE4/PSDDQM4/PBS4	B26
PWE5/PSDDQM5/PBS5	A26
PWE6/PSDDQM6/PBS6	B25
PWE7/PSDDQM7/PBS7	A25
PSDA10/PGPL0	E23
PSDWE/PGPL1	B24
POE/PSDRAS/PGPL2	A24
PSDCAS/PGPL3	B23
PGTA/PUPMWAIT/PGPL4/PPBS	A23
PSDAMUX/PGPL5	D22
LWE0/LSDDQM0/LBS0/PCI_CFG0 <sup>1</sup>	H28
LWE1/LSDDQM1/LBS1/PCI_CFG1 <sup>1</sup>	H27
LWE2/LSDDQM2/LBS2/PCI_CFG2 <sup>1</sup>	H26
LWE3/LSDDQM3/LBS3/PCI_CFG3 <sup>1</sup>	G29
LSDA10/LGPL0/PCI_MODCKH0 <sup>1</sup>	D27
LSDWE/LGPL1/PCI_MODCKH1 <sup>1</sup>	C28
LOE/LSDRAS/LGPL2/PCI_MODCKH2 <sup>1</sup>	E26
LSDCAS/LGPL3/PCI_MODCKH3 <sup>1</sup>	D25
LGTA/LUPMWAIT/LGPL4/LPBS	C26
LGPL5/PSDAMUX/PCI_MODCK <sup>1</sup>	B27
LWR	D28
L_A14/PAR <sup>1</sup>	N27
L_A15/FRAME <sup>1</sup> /SMI	T29
L_A16/TRDY <sup>1</sup>	R27
L_A17/IRDY <sup>1</sup> /CKSTP_OUT	R26
L_A18/STOP <sup>1</sup>	R29
L_A19/DEVSEL <sup>1</sup>	R28
L_A20/IDSEL <sup>1</sup>	W29
L_A21/PERR <sup>1</sup>	P28
L_A22/SERR <sup>1</sup>	N26
L_A23/REQ0 <sup>1</sup>	AA27
L_A24/REQ1 <sup>1</sup> /HSEJSW <sup>1</sup>	P29
L_A25/GNT0 <sup>1</sup>	AA26
L_A26/GNT1 <sup>1</sup> /HSLED <sup>1</sup>	N25
L_A27/GNT2 <sup>1</sup> /HSENUM <sup>1</sup>	AA25

**Table 21. Pinout List (continued)**

Pin Name	Ball
L_A28/RST <sup>1</sup> /CORE_SRESET	AB29
L_A29/INTA <sup>1</sup>	AB28
L_A30/REQ2 <sup>1</sup>	P25
L_A31/DLLOUT <sup>1</sup>	AB27
LCL_D0/AD0 <sup>1</sup>	H29
LCL_D1/AD1 <sup>1</sup>	J29
LCL_D2/AD2 <sup>1</sup>	J28
LCL_D3/AD3 <sup>1</sup>	J27
LCL_D4/AD4 <sup>1</sup>	J26
LCL_D5/AD5 <sup>1</sup>	J25
LCL_D6/AD6 <sup>1</sup>	K25
LCL_D7/AD7 <sup>1</sup>	L29
LCL_D8/AD8 <sup>1</sup>	L27
LCL_D9/AD9 <sup>1</sup>	L26
LCL_D10/AD10 <sup>1</sup>	L25
LCL_D11/AD11 <sup>1</sup>	M29
LCL_D12/AD12 <sup>1</sup>	M28
LCL_D13/AD13 <sup>1</sup>	M27
LCL_D14/AD14 <sup>1</sup>	M26
LCL_D15/AD15 <sup>1</sup>	N29
LCL_D16/AD16 <sup>1</sup>	T25
LCL_D17/AD17 <sup>1</sup>	U27
LCL_D18/AD18 <sup>1</sup>	U26
LCL_D19/AD19 <sup>1</sup>	U25
LCL_D20/AD20 <sup>1</sup>	V29
LCL_D21/AD21 <sup>1</sup>	V28
LCL_D22/AD22 <sup>1</sup>	V27
LCL_D23/AD23 <sup>1</sup>	V26
LCL_D24/AD24 <sup>1</sup>	W27
LCL_D25/AD25 <sup>1</sup>	W26
LCL_D26/AD26 <sup>1</sup>	W25
LCL_D27/AD27 <sup>1</sup>	Y29
LCL_D28/AD28 <sup>1</sup>	Y28
LCL_D29/AD29 <sup>1</sup>	Y25
LCL_D30/AD30 <sup>1</sup>	AA29

Table 21. Pinout List (continued)

Pin Name	Ball
LCL_D31/AD31 <sup>1</sup>	AA28
LCL_DP0/C0 <sup>1</sup> /BE0 <sup>1</sup>	L28
LCL_DP1/C1 <sup>1</sup> /BE1 <sup>1</sup>	N28
LCL_DP2/C2 <sup>1</sup> /BE2 <sup>1</sup>	T28
LCL_DP3/C3 <sup>1</sup> /BE3 <sup>1</sup>	W28
IRQ0/NMI_OUT	T1
IRQ7/INT_OUT/APE	D1
TRST	AH3
TCK	AG5
TMS	AJ3
TDI	AE6
TDO	AF5
TRIS	AB4
PORESET	AG6
HRESET	AH5
SRESET	AF6
QREQ	AA3
RSTCONF	AJ4
MODCK1/AP1/TC0/BNKSEL0	W2
MODCK2/AP2/TC1/BNKSEL1	W3
MODCK3/AP3/TC2/BNKSEL2	W4
XFC	AB2
CLKIN1	AH4
PA0/RESTART1/DREQ3/FCC2_UTM_TXADDR2	AC29 <sup>2</sup>
PA1/REJECT1/FCC2_UTM_TXADDR1/DONE3	AC25 <sup>2</sup>
PA2/CLK20/FCC2_UTM_TXADDR0/DACK3	AE28 <sup>2</sup>
PA3/CLK19/FCC2_UTM_RXADDR0/DACK4/L1RXD1A2	AG29 <sup>2</sup>
PA4/REJECT2/FCC2_UTM_RXADDR1/DONE4	AG28 <sup>2</sup>
PA5/RESTART2/DREQ4/FCC2_UTM_RXADDR2	AG26 <sup>2</sup>
PA6/L1RSYNCA1	AE24 <sup>2</sup>
PA7/SMSYN2/L1TSYNCA1/L1GN1A1	AH25 <sup>2</sup>
PA8/SMRXD2/L1RXD0A1/L1RXDA1	AF23 <sup>2</sup>
PA9/SMTXD2/L1TXD0A1	AH23 <sup>2</sup>
PA10/FCC1_UT8_RXD0/FCC1_UT16_RXD8/MSNUM5	AE22 <sup>2</sup>
PA11/FCC1_UT8_RXD1/FCC1_UT16_RXD9/MSNUM4	AH22 <sup>2</sup>

**Table 21. Pinout List (continued)**

Pin Name	Ball
PA12/FCC1_UT8_RXD2/FCC1_UT16_RXD10/MSNUM3	AJ21 <sup>2</sup>
PA13/FCC1_UT8_RXD3/FCC1_UT16_RXD11/MSNUM2	AH20 <sup>2</sup>
PA14/FCC1_UT8_RXD4/FCC1_UT16_RXD12/FCC1_RXD3	AG19 <sup>2</sup>
PA15/FCC1_UT8_RXD5/FCC1_UT16_RXD13/FCC1_RXD2	AF18 <sup>2</sup>
PA16/FCC1_UT8_RXD6/FCC1_UT16_RXD14/FCC1_RXD1	AF17 <sup>2</sup>
PA17/FCC1_UT8_RXD7/FCC1_UT16_RXD15/FCC1_RXD0/FCC1_RXD	AE16 <sup>2</sup>
PA18/FCC1_UT8_TXD7/FCC1_UT16_TXD15/FCC1_TXD0/FCC1_TXD	AJ16 <sup>2</sup>
PA19/FCC1_UT8_TXD6/FCC1_UT16_TXD14/FCC1_TXD1	AG15 <sup>2</sup>
PA20/FCC1_UT8_TXD5/FCC1_UT16_TXD13/FCC1_TXD2	AJ13 <sup>2</sup>
PA21/FCC1_UT8_TXD4/FCC1_UT16_TXD12/FCC1_TXD3	AE13 <sup>2</sup>
PA22/FCC1_UT8_TXD3/FCC1_UT16_TXD11	AF12 <sup>2</sup>
PA23/FCC1_UT8_TXD2/FCC1_UT16_TXD10	AG11 <sup>2</sup>
PA24/FCC1_UT8_TXD1/FCC1_UT16_TXD9/MSNUM1	AH9 <sup>2</sup>
PA25/FCC1_UT8_TXD0/FCC1_UT16_TXD8/MSNUM0	AJ8 <sup>2</sup>
PA26/FCC1_UTM_RXCLAV/FCC1_UTS_RXCLAV/FCC1_MII_RX_ER	AH7 <sup>2</sup>
PA27/FCC1_UT_RXSOC/FCC1_MII_RX_DV	AF7 <sup>2</sup>
PA28/FCC1_UTM_RXENB/FCC1_UTS_RXENB/FCC1_MII_TX_EN	AD5 <sup>2</sup>
PA29/FCC1_UT_TXSOC/FCC1_MII_TX_ER	AF1 <sup>2</sup>
PA30/FCC1_UTM_TXCLAV/FCC1_UTS_TXCLAV/FCC1_MII_CRS/ FCC1_RTS	AD3 <sup>2</sup>
PA31/FCC1_UTM_TXENB/FCC1_UTS_TXENB/FCC1_MII_COL	AB5 <sup>2</sup>
PB4/FCC3_TXD3/FCC2_UT8_RXD0/L1RSYNCA2/FCC3_RTS	AD28 <sup>2</sup>
PB5/FCC3_TXD2/FCC2_UT8_RXD1/L1TSYNCA2/L1GNTA2	AD26 <sup>2</sup>
PB6/FCC3_TXD1/FCC2_UT8_RXD2/L1RXDA2/L1RXD0A2	AD25 <sup>2</sup>
PB7/FCC3_TXD0/FCC3_TXD/FCC2_UT8_RXD3/L1TXDA2/L1TXD0A2	AE26 <sup>2</sup>
PB8/FCC2_UT8_TXD3/FCC3_RXD0/FCC3_RXD/TXD3/L1RSYNCD1	AH27 <sup>2</sup>
PB9/FCC2_UT8_TXD2/FCC3_RXD1/L1TXD2A2/L1TSYNCD1/L1GNTD1	AG24 <sup>2</sup>
PB10/FCC2_UT8_TXD1/FCC3_RXD2/L1RXDD1	AH24 <sup>2</sup>
PB11/FCC3_RXD3/FCC2_UT8_TXD0/L1TXDD1	AJ24 <sup>2</sup>
PB12/FCC3_MII_CRS/L1CLKOB1/L1RSYNCC1/TXD2	AG22 <sup>2</sup>
PB13/FCC3_MII_COL/L1RQB1/L1TSYNCC1/L1GNTC1/L1TXD1A2	AH21 <sup>2</sup>
PB14/FCC3_MII_TX_EN/RXD3/L1RXDC1	AG20 <sup>2</sup>
PB15/FCC3_MII_TX_ER/RXD2/L1TXDC1	AF19 <sup>2</sup>
PB16/FCC3_MII_RX_ER/L1CLKOA1/CLK18	AJ18 <sup>2</sup>
PB17/FCC3_MII_RX_DV/L1RQA1/CLK17	AJ17 <sup>2</sup>

**Table 21. Pinout List (continued)**

Pin Name	Ball
PB18/FCC2_UT8_RXD4/FCC2_RXD3/L1CLKOD2/L1RXD2A2	AE14 <sup>2</sup>
PB19/FCC2_UT8_RXD5/FCC2_RXD2/L1RQD2/L1RXD3A2	AF13 <sup>2</sup>
PB20/FCC2_UT8_RXD6/FCC2_RXD1/L1RSYNCD2/L1TXD1A1	AG12 <sup>2</sup>
PB21/FCC2_UT8_RXD7/FCC2_RXD0/FCC2_RXD/L1TSYNCD2/L1GN2D2/ L1TXD2A1	AH11 <sup>2</sup>
PB22/FCC2_UT8_TXD7/FCC2_TXD0/FCC2_TXD/L1RXD1A1/L1RXDD2	AH16 <sup>2</sup>
PB23/FCC2_UT8_TXD6/FCC2_TXD1/L1RXD2A1/L1TXDD2	AE15 <sup>2</sup>
PB24/FCC2_UT8_TXD5/FCC2_TXD2/L1RXD3A1/L1RSYNCC2	AJ9 <sup>2</sup>
PB25/FCC2_UT8_TXD4/FCC2_TXD3/L1TSYNCC2/L1GN2C2/L1TXD3A1	AE9 <sup>2</sup>
PB26/FCC2_MII_CRS/FCC2_UT8_TXD1/L1RXDC2	AJ7 <sup>2</sup>
PB27/FCC2_MII_COL/FCC2_UT8_TXD0/L1TXDC2	AH6 <sup>2</sup>
PB28/FCC2_MII_RX_ER/FCC2_RTS/L1TSYNCB2/L1GN2B2/TXD1	AE3 <sup>2</sup>
PB29/FCC2_UTM_RXCLAV/FCC2_UTS_RXCLAV/L1RSYNCB2/ FCC2_MII_TX_EN	AE2 <sup>2</sup>
PB30/FCC2_MII_RX_DV/FCC2_UT_TXSOC/L1RXDB2	AC5 <sup>2</sup>
PB31/FCC2_MII_TX_ER/FCC2_UT_RXSOC/L1TXDB2	AC4 <sup>2</sup>
PC0/DREQ1/BRGO7/SMSYN2/L1CLKOA2	AB26 <sup>2</sup>
PC1/DREQ2/BRGO6/L1RQA2	AD29 <sup>2</sup>
PC2/FCC3_CD/FCC2_UT8_TXD3/DONE2	AE29 <sup>2</sup>
PC3/FCC3_CTS/FCC2_UT8_TXD2/DACK2/CTS4	AE27 <sup>2</sup>
PC4/FCC2_UTM_RXENB/FCC2_UTS_RXENB/SI2_L1ST4/FCC2_CD	AF27 <sup>2</sup>
PC5/FCC2_UTM_TXCLAV/FCC2_UTS_TXCLAV/SI2_L1ST3/FCC2_CTS	AF24 <sup>2</sup>
PC6/FCC1_CD/L1CLKOC1/FCC1_UTM_RXADDR2/FCC1_UTS_RXADDR/ FCC1_UTM_RXCLAV1	AJ26 <sup>2</sup>
PC7/FCC1_CTS/L1RQC1/FCC1_UTM_TXADDR2/FCC1_UTS_TXADDR2/ FCC1_UTM_TXCLAV1	AJ25 <sup>2</sup>
PC8/CD4/RENA4/FCC1_UT16_TXD0/SI2_L1ST2/CTS3	AF22 <sup>2</sup>
PC9/CTS4/CLSN4/FCC1_UT16_TXD1/SI2_L1ST1/L1TSYNCA2/L1GN2A2	AE21 <sup>2</sup>
PC10/CD3/RENA3/FCC1_UT16_TXD2/SI1_L1ST4/FCC2_UT8_RXD3	AF20 <sup>2</sup>
PC11/CTS3/CLSN3/L1CLKOD1/L1TXD3A2/FCC2_UT8_RXD2	AE19 <sup>2</sup>
PC12/CD2/RENA2/SI1_L1ST3/FCC1_UTM_RXADDR1/ FCC1_UTS_RXADDR1	AE18 <sup>2</sup>
PC13/CTS2/CLSN2/L1RQD1/FCC1_UTM_TXADDR1/ FCC1_UTS_TXADDR1	AH18 <sup>2</sup>
PC14/CD1/RENA1/FCC1_UTM_RXADDR0/FCC1_UTS_RXADDR0	AH17 <sup>2</sup>
PC15/CTS1/CLSN1/SMTXD2/FCC1_UTM_TXADDR0/ FCC1_UTS_TXADDR0	AG16 <sup>2</sup>

**Table 21. Pinout List (continued)**

Pin Name	Ball
PC16/CLK16/TIN4	AF15 <sup>2</sup>
PC17/CLK15/TIN3/BRGO8	AJ15 <sup>2</sup>
PC18/CLK14/ $\overline{\text{TGATE2}}$	AH14 <sup>2</sup>
PC19/CLK13/BRGO7/SPICLK	AG13 <sup>2</sup>
PC20/CLK12/ $\overline{\text{TGATE1}}$	AH12 <sup>2</sup>
PC21/CLK11/BRGO6	AJ11 <sup>2</sup>
PC22/CLK10/ $\overline{\text{DONE1}}$	AG10 <sup>2</sup>
PC23/CLK9/BRGO5/ $\overline{\text{DACK1}}$	AE10 <sup>2</sup>
PC24/FCC2_UT8_TXD3/CLK8/ $\overline{\text{TOUT4}}$	AF9 <sup>2</sup>
PC25/FCC2_UT8_TXD2/CLK7/BRGO4	AE8 <sup>2</sup>
PC26/CLK6/ $\overline{\text{TOUT3}}$ /TMCLK	AJ6 <sup>2</sup>
PC27/FCC3_TXD/FCC3_TXD0/CLK5/BRGO3	AG2 <sup>2</sup>
PC28/CLK4/TIN1/ $\overline{\text{TOUT2}}$ / $\overline{\text{CTS2}}$ /CLSN2	AF3 <sup>2</sup>
PC29/CLK3/TIN2/BRGO2/ $\overline{\text{CTS1}}$ /CLSN1	AF2 <sup>2</sup>
PC30/FCC2_UT8_TXD3/CLK2/ $\overline{\text{TOUT1}}$	AE1 <sup>2</sup>
PC31/CLK1/BRGO1	AD1 <sup>2</sup>
PD4/BRGO8/L1TSYNCD1/L1GNTD1/ $\overline{\text{FCC3_RTS}}$ /SMRXD2	AC28 <sup>2</sup>
PD5/FCC1_UT16_TXD3/ $\overline{\text{DONE1}}$	AD27 <sup>2</sup>
PD6/FCC1_UT16_TXD4/ $\overline{\text{DACK1}}$	AF29 <sup>2</sup>
PD7/SMSYN1/FCC1_UTM_TXADDR3/FCC1_UTS_TXADDR3/ FCC2_UTM_TXADDR4/FCC1_TXCLAV2	AF28 <sup>2</sup>
PD8/SMRXD1/FCC2_UT_TXPRTY/BRGO5	AG25 <sup>2</sup>
PD9/SMTXD1/FCC2_UT_RXPRTY/BRGO3	AH26 <sup>2</sup>
PD10/L1CLKOB2/FCC2_UT8_RXD1/L1RSYNCB1/BRGO4	AJ27 <sup>2</sup>
PD11/ $\overline{\text{L1RQB2}}$ /FCC2_UT8_RXD0/L1TSYNCB1/L1GNTB1	AJ23 <sup>2</sup>
PD12/SI1_L1ST2/L1RXDB1	AG23 <sup>2</sup>
PD13/SI1_L1ST1/L1TXDB1	AJ22 <sup>2</sup>
PD14/FCC1_UT16_RXD0/L1CLKOC2/I2CSCL	AE20 <sup>2</sup>
PD15/FCC1_UT16_RXD1/ $\overline{\text{L1RQC2}}$ /I2CSDA	AJ20 <sup>2</sup>
PD16/FCC1_UT_TXPRTY/L1TSYNCC1/L1GNTC1/SPIMISO	AG18 <sup>2</sup>
PD17/FCC1_UT_RXPRTY/BRGO2/SPIMOSI	AG17 <sup>2</sup>
PD18/FCC1_UTM_RXADDR4/FCC1_UTS_RXADDR4/ FCC1_UTM_RXCLAV3/FCC2_UTM_RXADDR3/SPICLK	AF16 <sup>2</sup>
PD19/FCC1_UTM_TXADDR4/FCC1_UTS_TXADDR4/ FCC1_UTM_TXCLAV3/FCC2_UTM_TXADDR3/SPISEL/BRGO1	AH15 <sup>2</sup>
PD20/ $\overline{\text{RTS4}}$ /TENA4/FCC1_UT16_RXD2/L1RSYNCA2	AJ14 <sup>2</sup>

**Table 21. Pinout List (continued)**

Pin Name	Ball
PD21/TXD4/FCC1_UT16_RXD3/L1RXD0A2/L1RXDA2	AH13 <sup>2</sup>
PD22/RXD4/FCC1_UT16_TXD5/L1TXD0A2/L1TXDA2	AJ12 <sup>2</sup>
PD23/ $\overline{\text{RTS3}}$ /TENA3/FCC1_UT16_RXD4/L1RSYNCD1	AE12 <sup>2</sup>
PD24/TXD3/FCC1_UT16_RXD5/L1RXDD1	AF10 <sup>2</sup>
PD25/RXD3/FCC1_UT16_TXD6/L1TXDD1	AG9 <sup>2</sup>
PD26/ $\overline{\text{RTS2}}$ /TENA2/FCC1_UT16_RXD6/L1RSYNCC1	AH8 <sup>2</sup>
PD27/TXD2/FCC1_UT16_RXD7/L1RXDC1	AG7 <sup>2</sup>
PD28/RXD2/FCC1_UT16_TXD7/L1TXDC1	AE4 <sup>2</sup>
PD29/ $\overline{\text{RTS1}}$ /TENA1/FCC1_UTM_RXADDR3/FCC1_UTS_RXADDR3/ FCC1_UTM_RXCLAV2/FCC2_UTM_RXADDR4	AG1 <sup>2</sup>
PD30/ $\overline{\text{FCC2\_UTM\_TXENB}}$ /FCC2_UTS_TXENB/TXD1	AD4 <sup>2</sup>
PD31/RXD1	AD2 <sup>2</sup>
VCCSYN	AB3
VCCSYN1	B9
GNDSYN	AB1
CLKIN2 <sup>1,3</sup>	AE11
SPARE4 <sup>4</sup>	U5
$\overline{\text{PCI\_MODE}}$ <sup>1,5</sup>	AF25
SPARE6 <sup>4</sup>	V4
THERMAL0 <sup>6</sup>	AA1
THERMAL1 <sup>6</sup>	AG4
I/O power	AG21, AG14, AG8, AJ1, AJ2, AH1, AH2, AG3, AF4, AE5, AC27, Y27, T27, P27, K26, G27, AE25, AF26, AG27, AH28, AH29, AJ28, AJ29, C7, C14, C16, C20, C23, E10, A28, A29, B28, B29, C27, D26, E25, H3, M4, T3, AA4, A1, A2, B1, B2, C3, D4, E5
Core Power	U28, U29, K28, K29, A9, A19, B19, M1, M2, Y1, Y2, AC1, AC2, AH19, AJ19, AH10, AJ10, AJ5
Ground	AA5, AF21, AF14, AF8, AE7, AF11, AE17, AE23, AC26, AB25, Y26, V25, T26, R25, P26, M25, K27, H25, G26, D7, D10, D14, D16, D20, D23, C9, E11, E13, E15, E19, E22, B3, G5, H4, K5, M3, P5, T4, Y5, AA2, AC3

<sup>1</sup> MPC8265 and MPC8266 only.

<sup>2</sup> The default configuration of the CPM pins (PA[0–31], PB[4–31], PC[0–31], PD[4–31]) is input. To prevent excessive DC current, it is recommended to either pull unused pins to GND or VDDH, or to configure them as outputs.

## Package Description

- <sup>3</sup> On PCI devices (MPC8265 and MPC8266) this pin should be used as CLKIN2. On non-PCI devices (MPC8260A and MPC8264) this is a spare pin that must be pulled down or left floating.
- <sup>4</sup> Must be pulled down or left floating.
- <sup>5</sup> On PCI devices (MPC8265 and MPC8266) this pin should be asserted if the PCI function is desired or pulled up or left floating if PCI is not desired. On non-PCI devices (MPC8260A and MPC8264) this is a spare pin that must be pulled up or left floating.
- <sup>6</sup> For information on how to use this pin, refer to *MPC8260 PowerQUICC II Thermal Resistor Guide* available at [www.freescale.com](http://www.freescale.com).

# 5 Package Description

The following sections provide the package parameters and mechanical dimensions for the MPC826xA.

## 5.1 Package Parameters

Package parameters are provided in [Table 22](#). The package type is a 37.5 × 37.5 mm, 480-lead TBGA.

**Table 22. Package Parameters**

Parameter	Value
Package Outline	37.5 × 37.5 mm
Interconnects	480 (29 × 29 ball array)
Pitch	1.27 mm
Nominal unmounted package height	1.55 mm

## 5.2 Mechanical Dimensions

Figure 15 provides the mechanical dimensions and bottom surface nomenclature of the 480 TBGA package.

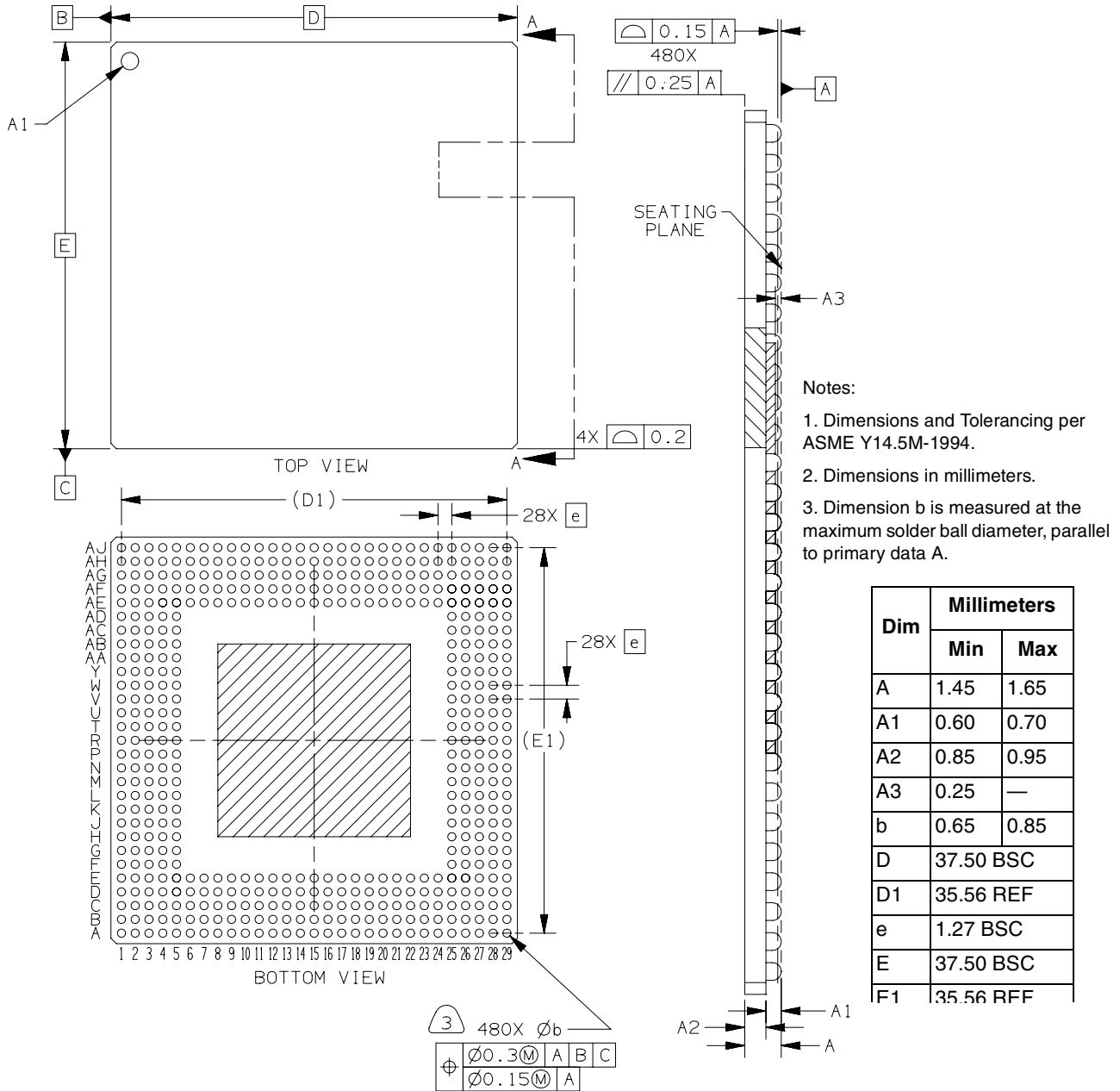

Figure 15. Mechanical Dimensions and Bottom Surface Nomenclature

## 6 Ordering Information

Figure 16 provides an example of the Freescale part numbering nomenclature for the MPC826xA. In addition to the processor frequency, the part numbering scheme also consists of a part modifier that indicates any enhancement(s) in the part from the original production design. Each part number also contains a revision code that refers to the die mask revision number and is specified in the part numbering scheme for identification purposes only. For more information, contact your local Freescale sales office.



Figure 16. Freescale Part Number Key

## 7 Document Revision History

Table 23 lists significant changes in each revision of this document.

Table 23. Document Revision History

Revision	Date	Substantive Changes
2	06/2009	<ul style="list-style-type: none"> <li>Updated package values in <a href="#">Figure 16</a>.</li> </ul>
1.1	02/2006	<ul style="list-style-type: none"> <li>Addition of <a href="#">Table 12</a>.</li> </ul>
1.0	9/2005	<ul style="list-style-type: none"> <li>Document template update</li> </ul>

**Table 23. Document Revision History (continued)**

Revision	Date	Substantive Changes
0.9	8/2003	<ul style="list-style-type: none"> <li>Note: In revision 0.3, sp30 (Table 10) was changed. This change was not previously recorded in this “Document Revision History” Table.</li> <li>Removal of “HiP4 PowerQUICC II Documentation” table. These supplemental specifications have been replaced by revision 1 of the <i>MPC8260 PowerQUICC II™ Family Reference Manual</i>.</li> <li>Figure 1 and Section 1, “Features”: Addition of MPC8255 notes</li> <li>Addition of Figure 2</li> <li>Addition of VCCSYN to “Note: Core, PLL, and I/O Supply Voltages” following Table 2</li> <li>Addition of note 1 to Table 3</li> <li>Table 4: Changes to <math>\theta_{JA}</math> and <math>\theta_{JB}</math> and <math>\theta_{JC}</math>.</li> <li>Addition of notes or modifications to Figure 6, Figure 7, and Figure 8</li> <li>Table 9: Change of sp10.</li> <li>Addition of Table 15.</li> <li>Addition of note 2 to Table 21</li> <li>Table 21: Addition of FCC2 Rx and Tx [3,4] to CPM pins PD7, PD18, PD19, and PD29. Also, the addition of SPICLK to PC19. They are documented correctly in the parallel I/O ports chapter in the <i>MPC8260 PowerQUICC II™ Family Reference Manual</i> but had previously been omitted from Table 21.</li> </ul>
0.8	1/2003	<ul style="list-style-type: none"> <li>Table 2: Modification to supply voltage ranges reflected in notes 2, 3, and 4.</li> <li>Table 4: Addition of <math>\theta_{JB}</math> and <math>\theta_{JC}</math>.</li> <li>Table 7, Figure 8: Addition of sp42a/sp43a.</li> <li>Figure 3, Figure 4: Addition of note for FCC output.</li> <li>Figure 5, Figure 6, Figure 7: Addition of notes.</li> <li>Table 14, Table 17, and Table 19: Removal of PLL bypass mode from clock tables.</li> </ul>
0.7	5/2002	<ul style="list-style-type: none"> <li>Section 1, “Features”: minimum supported core frequency of 150 MHz</li> <li>Section 1, “Features”: updated performance values (under “Dual-issue integer core”)</li> <li>Table 2: Note 2 (changes in italics): “...less than or equal to 233 MHz, 166 MHz CPM...”</li> <li>Table 2: Addition of note 3.</li> </ul>
0.6	3/2002	<ul style="list-style-type: none"> <li>Table 21: Modified notes to pins AE11 and AF25.</li> </ul>
0.5	3/2002	<ul style="list-style-type: none"> <li>Table 21: Modified notes to pins AE11 and AF25.</li> <li>Table 21: Addition of note to pins AA1 and AG4 (Therm0 and Therm1).</li> </ul>
0.4	2/2002	<ul style="list-style-type: none"> <li>Note 2 for Table 2 (changes in italics): “...greater than or equal to 266 MHz, 200 MHz CPM...”</li> <li>Table 19: Core and bus frequency values for the following ranges of MODCK_HMODCK: 0011_000 to 0011_100 and 1011_000 to 1011_1000</li> <li>Table 21: Notes added to pins at AE11, AF25, U5, and V4.</li> </ul>
0.3	11/2001	<ul style="list-style-type: none"> <li>Table 1: note 3</li> <li>Section 2.1: Removal of “Warning” recommending use of bootstrap diodes. They are not needed.</li> <li>Table 9: Change to sp12.</li> <li>Table 10: Change to sp32.</li> <li>Note 2 for Table 16 and Table 17</li> <li>Addition of note at beginning of Section 3.2</li> <li>Note 1 for Table 18 and Table 19</li> <li>Table 21: Additions to B27, C28, D25, D27, E26, G29, H26–28, N25, P29, AF25, AA25, AB27</li> </ul>
0.2	11/2001	<ul style="list-style-type: none"> <li>Revision of Table 5, “Power Dissipation”</li> <li>Modifications to Figure 9, Table 2, Table 10, Table 11, and Table 18</li> <li>Modification to pinout diagram, Figure 13</li> <li>Additional revisions to text and figures throughout</li> </ul>
0.1	8/2001	<ul style="list-style-type: none"> <li>Table 8: Change to sp20/sp21.</li> </ul>
0	—	Initial version

## How to Reach Us:

### Home Page:

[www.freescale.com](http://www.freescale.com)

### Web Support:

<http://www.freescale.com/support>

### USA/Europe or Locations Not Listed:

Freescale Semiconductor, Inc.  
 Technical Information Center, EL516  
 2100 East Elliot Road  
 Tempe, Arizona 85284  
 1-800-521-6274 or  
 +1-480-768-2130  
[www.freescale.com/support](http://www.freescale.com/support)

### Europe, Middle East, and Africa:

Freescale Halbleiter Deutschland GmbH  
 Technical Information Center  
 Schatzbogen 7  
 81829 Muenchen, Germany  
 +44 1296 380 456 (English)  
 +46 8 52200080 (English)  
 +49 89 92103 559 (German)  
 +33 1 69 35 48 48 (French)  
[www.freescale.com/support](http://www.freescale.com/support)

### Japan:

Freescale Semiconductor Japan Ltd.  
 Headquarters  
 ARCO Tower 15F  
 1-8-1, Shimo-Meguro, Meguro-ku  
 Tokyo 153-0064  
 Japan  
 0120 191014 or  
 +81 3 5437 9125  
[support.japan@freescale.com](mailto:support.japan@freescale.com)

### Asia/Pacific:

Freescale Semiconductor China Ltd.  
 Exchange Building 23F  
 No. 118 Jianguo Road  
 Chaoyang District  
 Beijing 100022  
 China  
 +86 10 5879 8000  
[support.asia@freescale.com](mailto:support.asia@freescale.com)

### For Literature Requests Only:

Freescale Semiconductor  
 Literature Distribution Center  
 1-800 441-2447 or  
 +1-303-675-2140  
 Fax: +1-303-675-2150  
[LDCForFreescaleSemiconductor@hibbertgroup.com](mailto:LDCForFreescaleSemiconductor@hibbertgroup.com)

Information in this document is provided solely to enable system and software implementers to use Freescale Semiconductor products. There are no express or implied copyright licenses granted hereunder to design or fabricate any integrated circuits or integrated circuits based on the information in this document.

Freescale Semiconductor reserves the right to make changes without further notice to any products herein. Freescale Semiconductor makes no warranty, representation or guarantee regarding the suitability of its products for any particular purpose, nor does Freescale Semiconductor assume any liability arising out of the application or use of any product or circuit, and specifically disclaims any and all liability, including without limitation consequential or incidental damages. "Typical" parameters which may be provided in Freescale Semiconductor data sheets and/or specifications can and do vary in different applications and actual performance may vary over time. All operating parameters, including "Typicals" must be validated for each customer application by customer's technical experts. Freescale Semiconductor does not convey any license under its patent rights nor the rights of others. Freescale Semiconductor products are not designed, intended, or authorized for use as components in systems intended for surgical implant into the body, or other applications intended to support or sustain life, or for any other application in which the failure of the Freescale Semiconductor product could create a situation where personal injury or death may occur. Should Buyer purchase or use Freescale Semiconductor products for any such unintended or unauthorized application, Buyer shall indemnify and hold Freescale Semiconductor and its officers, employees, subsidiaries, affiliates, and distributors harmless against all claims, costs, damages, and expenses, and reasonable attorney fees arising out of, directly or indirectly, any claim of personal injury or death associated with such unintended or unauthorized use, even if such claim alleges that Freescale Semiconductor was negligent regarding the design or manufacture of the part.

Freescale, the Freescale logo, and StarCore are trademarks or registered trademarks of Freescale Semiconductor, Inc. in the U.S. and other countries. All other product or service names are the property of their respective owners. The Power Architecture and Power.org word marks and the Power and Power.org logos and related marks are trademarks and service marks licensed by Power.org. IEEE 802.3 and 1149.1 are registered trademarks of the Institute of Electrical and Electronics Engineers, Inc. (IEEE). This product is not endorsed or approved by the IEEE.

© Freescale Semiconductor, Inc., 2005–2009. All rights reserved.



## Looking for pricing, stock, or lifecycle information?

Click below to explore more details on WIN SOURCE:

 [View MPC8265ACZUMHBC on WIN SOURCE](#)

 [NXP / Nexperia Information](#)

## Optimize Your Supply Chain with WIN SOURCE Solutions

-  Global Sourcing Solution
-  Obsolete Management
-  Cost Control Management
-  Shortage Management
-  Alternative Solution
-  Excess Inventory Management