



**THE DATASHEET OF  
BDP953H6327XTSA1**



**Silicon NPN Transistors**

- For AF driver and output stages
- High collector current
- High current gain
- Low collector-emitter saturation voltage
- Complementary types: BDP948, BDP950, BDP954 (PNP)
- Pb-free (RoHS compliant) package
- Qualified according AEC Q101

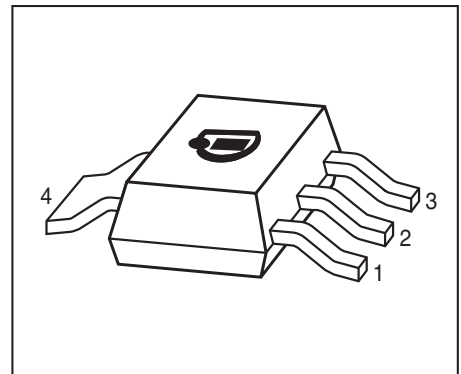

Type	Marking	Pin Configuration						Package
		1=B	2=C	3=E	4=C	-	-	
BDP947	BDP947	1=B	2=C	3=E	4=C	-	-	SOT223
BDP949	BDP949	1=B	2=C	3=E	4=C	-	-	SOT223
BDP953	BDP953	1=B	2=C	3=E	4=C	-	-	SOT223

**Maximum Ratings**

Parameter	Symbol	Value	Unit
Collector-emitter voltage	$V_{CEO}$		V
BDP947		45	
BDP949		60	
BDP953		100	
Collector-base voltage	$V_{CBO}$		
BDP947		45	
BDP949		60	
BDP953		120	
Emitter-base voltage	$V_{EBO}$	5	
Collector current	$I_C$	3	A
Peak collector current, $t_p \leq 10$ ms	$I_{CM}$	5	
Base current	$I_B$	200	mA
Peak base current, $t_p \leq 10$ ms	$I_{BM}$	500	
Total power dissipation- $T_S \leq 100$ °C	$P_{tot}$	5	W
Junction temperature	$T_j$	150	°C
Storage temperature	$T_{stg}$	-65 ... 150	

**Thermal Resistance**

Parameter	Symbol	Value	Unit
Junction - soldering point <sup>1)</sup>	$R_{thJS}$	$\leq 10$	K/W

**Electrical Characteristics at  $T_A = 25^\circ\text{C}$ , unless otherwise specified**

Parameter	Symbol	Values			Unit
		min.	typ.	max.	
<b>DC Characteristics</b>					
Collector-emitter breakdown voltage $I_C = 10\text{ mA}$ , $I_B = 0$ , BDP947 $I_C = 10\text{ mA}$ , $I_B = 0$ , BDP949 $I_C = 10\text{ mA}$ , $I_B = 0$ , BDP953	$V_{(BR)CEO}$	45 60 100	- - -	- - -	V
Collector-base breakdown voltage $I_C = 100\text{ }\mu\text{A}$ , $I_E = 0$ , BDP947 $I_C = 100\text{ }\mu\text{A}$ , $I_E = 0$ , BDP949 $I_C = 0$ , $I_E = 100\text{ }\mu\text{A}$ , BDP953	$V_{(BR)CBO}$	45 60 120	- - -	- - -	
Emitter-base breakdown voltage $I_E = 10\text{ }\mu\text{A}$ , $I_C = 0$	$V_{(BR)EBO}$	5	-	-	
Collector-base cutoff current $V_{CB} = 45\text{ V}$ , $I_E = 0$ $V_{CB} = 45\text{ V}$ , $I_E = 0$ , $T_A = 150\text{ }^\circ\text{C}$	$I_{CBO}$	- -	- -	0.1 20	$\mu\text{A}$
Emitter-base cutoff current $V_{EB} = 4\text{ V}$ , $I_C = 0$	$I_{EBO}$	-	-	100	nA
DC current gain <sup>2)</sup> $I_C = 10\text{ mA}$ , $V_{CE} = 5\text{ V}$ $I_C = 500\text{ mA}$ , $V_{CE} = 1\text{ V}$ $I_C = 2\text{ A}$ , $V_{CE} = 2\text{ V}$ , BDP947, BDP949 $I_C = 2\text{ A}$ , $V_{CE} = 2\text{ V}$ , BDP953	$h_{FE}$	25 100 50 15	- - - -	- 475 - -	-
Collector-emitter saturation voltage <sup>2)</sup> $I_C = 2\text{ A}$ , $I_B = 0.2\text{ A}$	$V_{CEsat}$	-	-	0.5	V
Base emitter saturation voltage <sup>2)</sup> $I_C = 2\text{ A}$ , $I_B = 0.2\text{ A}$	$V_{BEsat}$	-	-	1.3	

**AC Characteristics**

Transition frequency $I_C = 50\text{ mA}$ , $V_{CE} = 10\text{ V}$ , $f = 100\text{ MHz}$	$f_T$	-	100	-	MHz
Collector-base capacitance $V_{CB} = 10\text{ V}$ , $f = 1\text{ MHz}$	$C_{cb}$	-	25	-	pF

<sup>1</sup>For calculation of  $R_{thJA}$  please refer to Application Note AN077 (Thermal Resistance Calculation)

<sup>2</sup>Pulse test:  $t < 300\mu\text{s}$ ;  $D < 2\%$

**DC current gain  $h_{FE} = f(I_C)$**

$V_{CE} = 2\text{ V}$

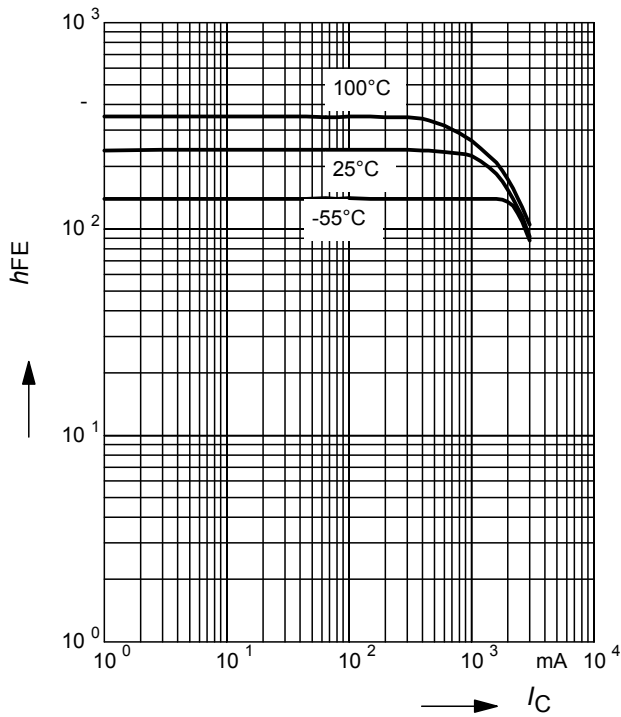

**Collector-emitter saturation voltage**

$I_C = f(V_{CEsat}), h_{FE} = 10$

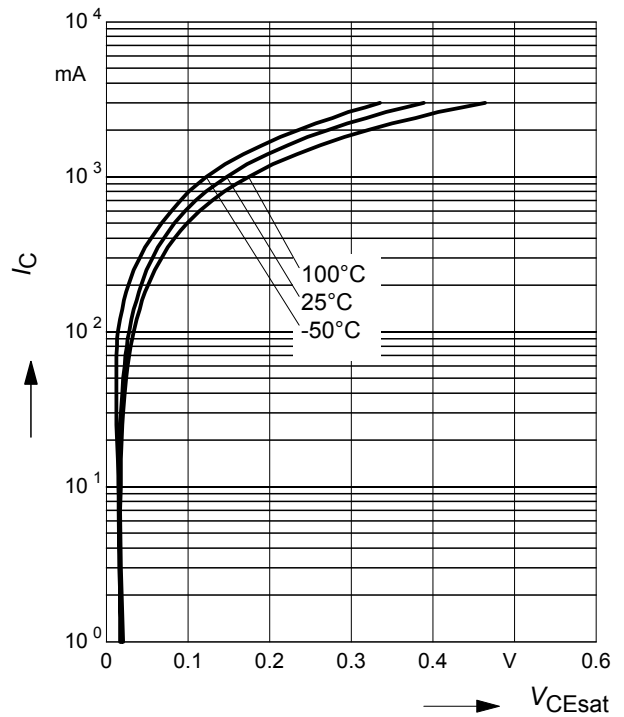

**Base-emitter saturation voltage**

$I_C = f(V_{BEsat}), h_{FE} = 10$

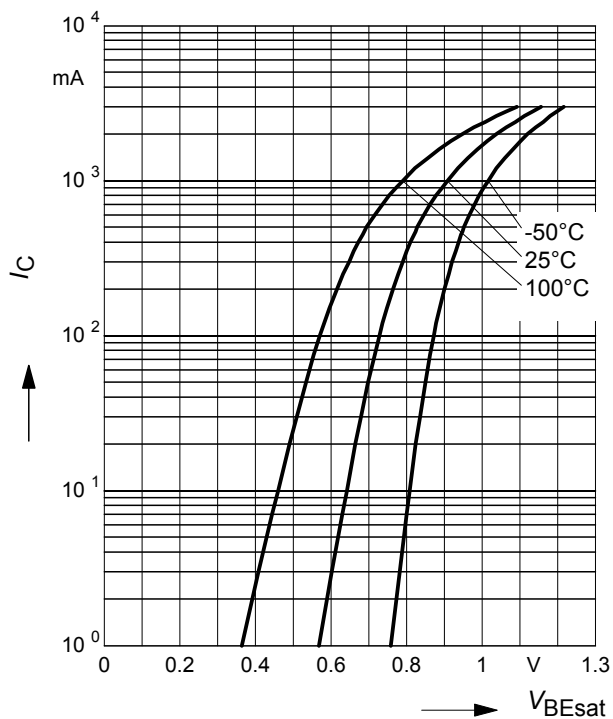

**Collector current  $I_C = f(V_{BE})$**

$V_{CE} = 2\text{ V}$

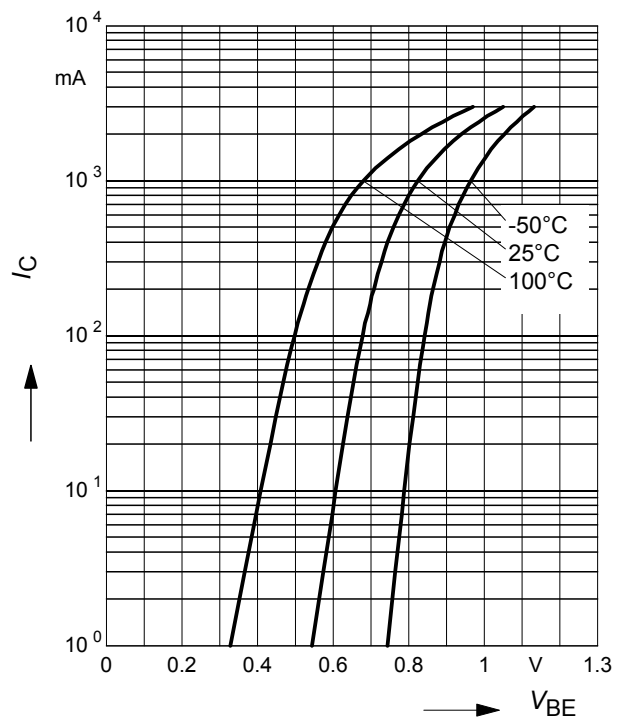

Collector cutoff current  $I_{CBO} = f(T_A)$

$V_{CB} = 45\text{ V}$

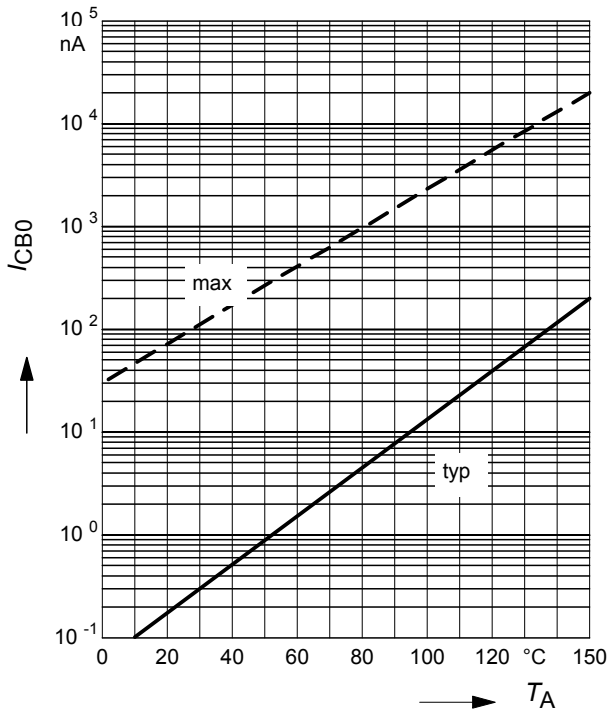

Collector-base capacitance  $C_{cb} = f(V_{CB})$

Emitter-base capacitance  $C_{eb} = f(V_{EB})$

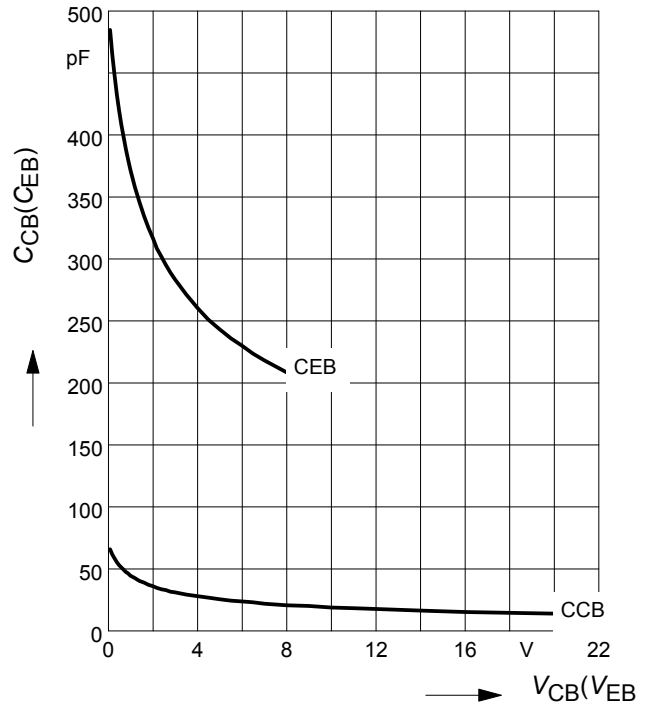

Total power dissipation  $P_{tot} = f(T_S)$

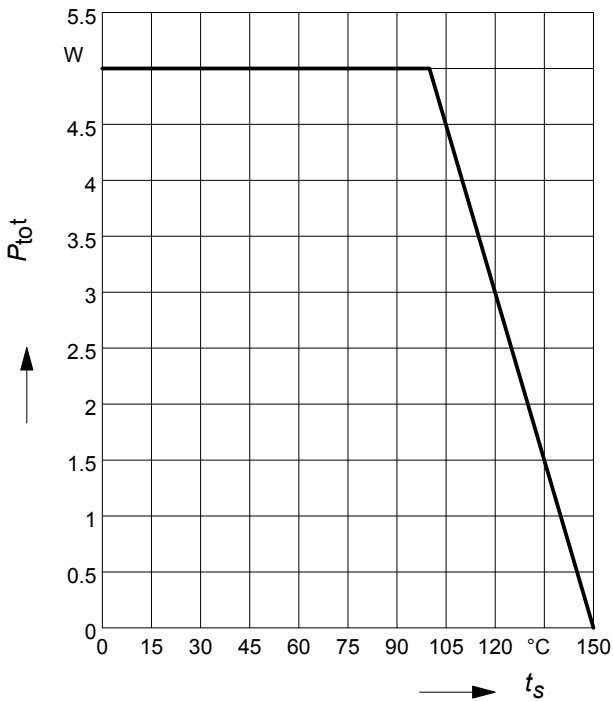

Permissible Pulse Load  $R_{thJS} = f(t_p)$

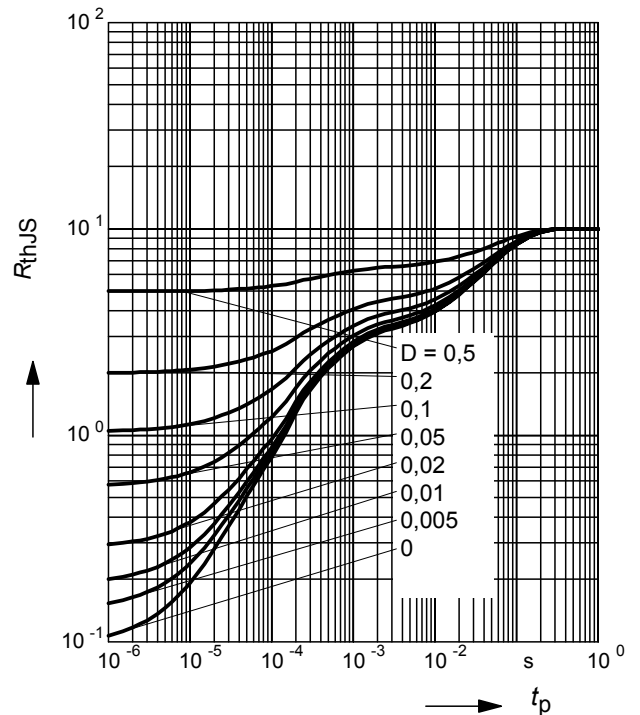

**Permissible Pulse Load**

$$P_{\text{totmax}}/P_{\text{totDC}} = f(t_p)$$

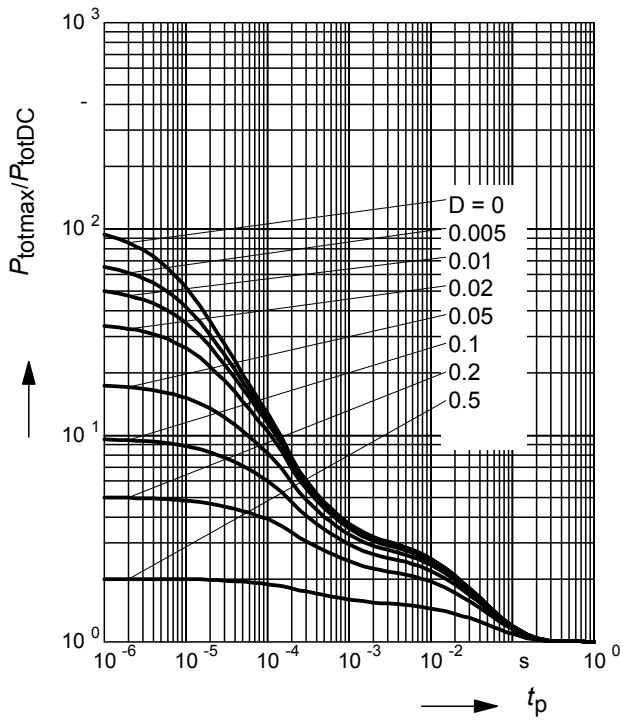

Package Outline

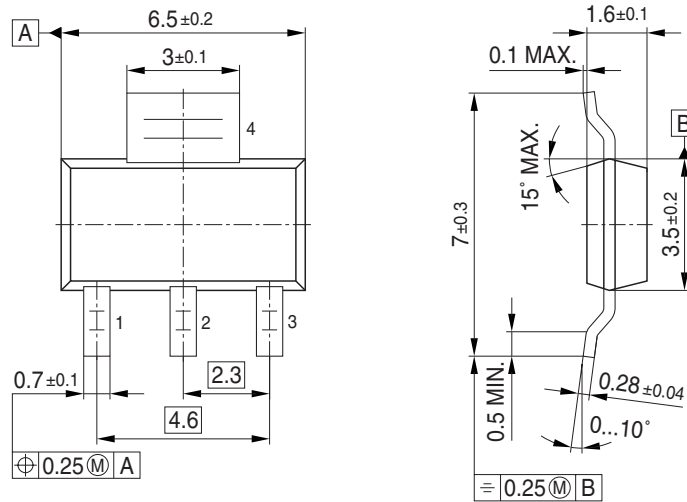
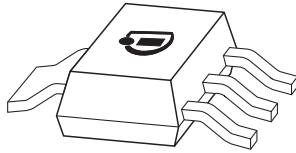

Foot Print

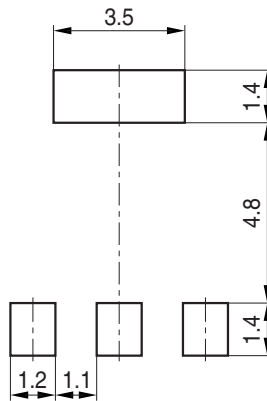

Marking Layout (Example)

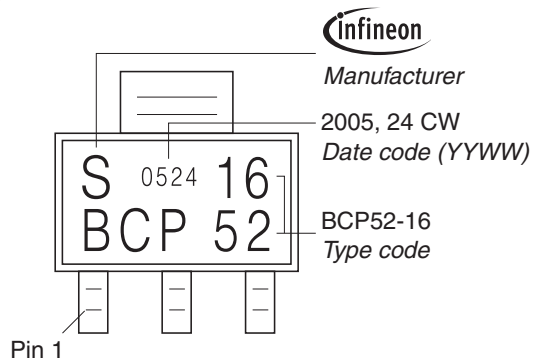

Packing

Reel  $\varnothing 180$  mm = 1.000 Pieces/Reel  
 Reel  $\varnothing 330$  mm = 4.000 Pieces/Reel

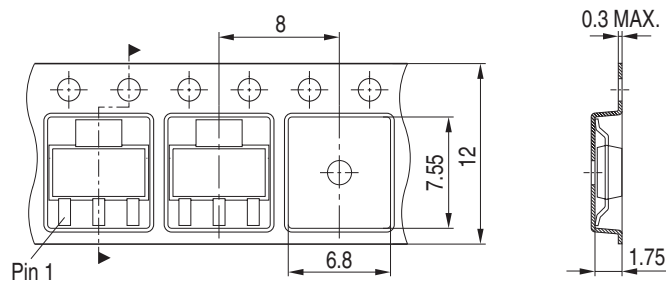

**Edition 2009-11-16**

**Published by  
Infineon Technologies AG  
81726 Munich, Germany**

**© 2009 Infineon Technologies AG  
All Rights Reserved.**

### **Legal Disclaimer**

The information given in this document shall in no event be regarded as a guarantee of conditions or characteristics. With respect to any examples or hints given herein, any typical values stated herein and/or any information regarding the application of the device, Infineon Technologies hereby disclaims any and all warranties and liabilities of any kind, including without limitation, warranties of non-infringement of intellectual property rights of any third party.

### **Information**

For further information on technology, delivery terms and conditions and prices, please contact the nearest Infineon Technologies Office ([www.infineon.com](http://www.infineon.com)).



### **Warnings**

Due to technical requirements, components may contain dangerous substances. For information on the types in question, please contact the nearest Infineon Technologies Office.

Infineon Technologies components may be used in life-support devices or systems only with the express written approval of Infineon Technologies, if a failure of such components can reasonably be expected to cause the failure of that life-support device or system or to affect the safety or effectiveness of that device or system. Life support devices or systems are intended to be implanted in the human body or to support and/or maintain and sustain and/or protect human life. If they fail, it is reasonable to assume that the health of the user or other persons may be endangered.

## Looking for pricing, stock, or lifecycle information?

Click below to explore more details on WIN SOURCE:

-  [View BDP953H6327XTSA1 on WIN SOURCE](#)
-  [Infineon Technologies Information](#)

## Optimize Your Supply Chain with WIN SOURCE Solutions

-  Global Sourcing Solution
-  Obsolete Management
-  Cost Control Management
-  Shortage Management
-  Alternative Solution
-  Excess Inventory Management