

DATA SHEET

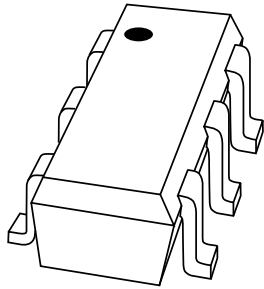

BF1102; BF1102R Dual N-channel dual gate MOS-FETs

Product specification
Supersedes data of 1999 Jul 01

2000 Apr 11



Dual N-channel dual gate MOS-FETs

BF1102; BF1102R

FEATURES

- Two low noise gain controlled amplifiers in a single package
- Specially designed for 5 V applications
- Superior cross-modulation performance during AGC
- High forward transfer admittance
- High forward transfer admittance to input capacitance ratio.

APPLICATIONS

Gain controlled low noise amplifier for VHF and UHF applications such as television tuners and professional communications equipment.

DESCRIPTION

The BF1102 and BF1102R are both two equal dual gate MOS-FETs which have a shared source pin and a shared gate 2 pin. Both devices have interconnected source and substrate; an internal bias circuit enables DC stabilization and a very good cross-modulation performance at 5 V supply voltage; integrated diodes between the gates and source protect against excessive input voltage surges. Both devices have a SOT363 micro-miniature plastic package.

PINNING - SOT363

PIN	DESCRIPTION	
	BF1102	BF1102R
1	gate 1 (1)	gate 1 (1)
2	gate 2 (1 and 2)	source (1 and 2)
3	drain (1)	drain (1)
4	drain (2)	drain (2)
5	source (1 and 2)	gate 2 (1 and 2)
6	gate 1 (2)	gate 1 (2)

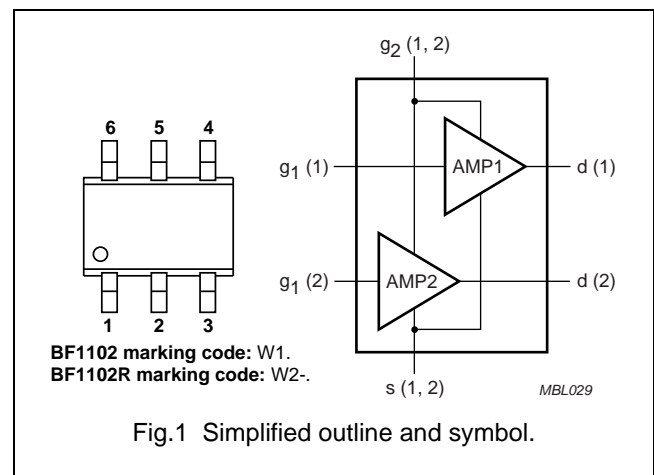

Fig.1 Simplified outline and symbol.

QUICK REFERENCE DATA

SYMBOL	PARAMETER	CONDITIONS	MIN.	TYP.	MAX.	UNIT
Per MOS-FET unless otherwise specified						
V_{DS}	drain-source voltage		–	–	7	V
I_D	drain current (DC)		–	–	40	mA
P_{tot}	total power dissipation	$T_s \leq 102\text{ }^\circ\text{C}$; note 1	–	–	200	mW
$ y_{fs} $	forward transfer admittance	$I_D = 15\text{ mA}$	36	43	–	mS
C_{ig1-s}	input capacitance at gate 1	$I_D = 15\text{ mA}$	–	2.8	3.6	pF
C_{rss}	reverse transfer capacitance	$f = 1\text{ MHz}$	–	30	50	fF
F	noise figure	$f = 800\text{ MHz}$	–	2	2.8	dB
X_{mod}	cross-modulation	input level for $k = 1\%$ at 40 dB AGC	100	–	–	dB μ V
T_j	operating junction temperature		–	–	150	$^\circ\text{C}$

Note

1. T_s is the temperature at the soldering point of the source lead.

CAUTION

This product is supplied in anti-static packing to prevent damage caused by electrostatic discharge during transport and handling.

Dual N-channel dual gate MOS-FETs

BF1102; BF1102R

LIMITING VALUES

In accordance with the Absolute Maximum Rating System (IEC 60134).

SYMBOL	PARAMETER	CONDITIONS	MIN.	MAX.	UNIT
Per MOS-FET unless otherwise specified					
V_{DS}	drain-source voltage		–	7	V
I_D	drain current (DC)		–	40	mA
I_{G1}	gate 1 current		–	±10	mA
I_{G2}	gate 2 current		–	±10	mA
P_{tot}	total power dissipation	$T_s \leq 102\text{ °C}$	–	200	mW
T_{stg}	storage temperature		–65	+150	°C
T_j	operating junction temperature		–	150	°C

THERMAL CHARACTERISTICS

SYMBOL	PARAMETER	VALUE	UNIT
$R_{th\ j-s}$	thermal resistance from junction to soldering point	240	K/W

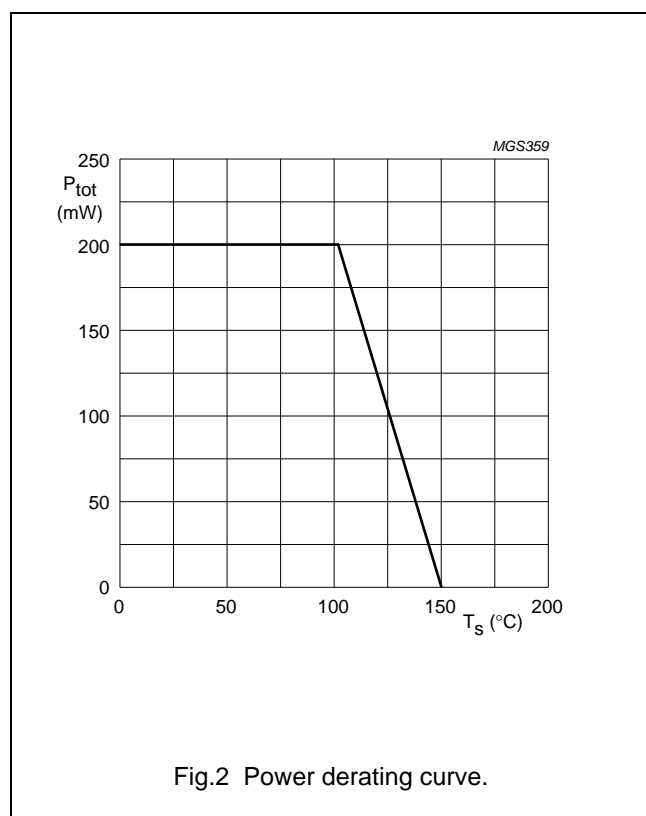

Dual N-channel dual gate MOS-FETs

BF1102; BF1102R

STATIC CHARACTERISTICS

$T_j = 25\text{ °C}$ unless otherwise specified.

SYMBOL	PARAMETER	CONDITIONS	MIN.	MAX.	UNIT
Per MOS-FET unless otherwise specified					
$V_{(BR)DSS}$	drain-source breakdown voltage	$V_{G1-S} = V_{G2-S} = 0$; $I_D = 10\text{ }\mu\text{A}$	7	–	V
$V_{(BR)G1-SS}$	gate 1-source breakdown voltage	$V_{GS} = V_{DS} = 0$; $I_{G1-S} = 10\text{ mA}$	6	15	V
$V_{(BR)G2-SS}$	gate 2-source breakdown voltage	$V_{GS} = V_{DS} = 0$; $I_{G2-S} = 5\text{ mA}$	6	15	V
$V_{(F)S-G1}$	forward source-gate 1 voltage	$V_{G2-S} = V_{DS} = 0$; $I_{S-G1} = 10\text{ mA}$	0.5	1.5	V
$V_{(F)S-G2}$	forward source-gate 2 voltage	$V_{G1-S} = V_{DS} = 0$; $I_{S-G2} = 10\text{ mA}$	0.5	1.5	V
$V_{G1-S(th)}$	gate 1-source threshold voltage	$V_{DS} = 5\text{ V}$; $V_{G2-S} = 4\text{ V}$; $I_D = 100\text{ }\mu\text{A}$	0.3	1	V
$V_{G2-S(th)}$	gate 2-source threshold voltage	$V_{DS} = 5\text{ V}$; $V_{G1-S} = 4\text{ V}$; $I_D = 100\text{ }\mu\text{A}$	0.3	1.2	V
I_{DSX}	drain-source current	$V_{G2-S} = 4\text{ V}$; $V_{DS} = 5\text{ V}$; $R_G = 120\text{ k}\Omega$; note 1	12	20	mA
I_{G1-S}	gate 1 cut-off current	$V_{G1-S} = 5\text{ V}$; $V_{G2-S} = V_{DS} = 0$	–	50	nA
I_{G2-S}	gate 2 cut-off current	$V_{G2-S} = 5\text{ V}$; $V_{G1-S} = V_{DS} = 0$	–	20	nA

Note

- R_{G1} connects gate 1 to $V_{GG} = 5\text{ V}$.

DYNAMIC CHARACTERISTICS

Common source; $T_{amb} = 25\text{ °C}$; $V_{G2-S} = 4\text{ V}$; $V_{DS} = 5\text{ V}$; $I_D = 15\text{ mA}$; unless otherwise specified.

SYMBOL	PARAMETER	CONDITIONS	MIN.	TYP.	MAX.	UNIT
Per MOS-FET unless otherwise specified (note 1)						
$ y_{fs} $	forward transfer admittance	$T_j = 25\text{ °C}$	36	43	50	mS
C_{ig1-ss}	input capacitance at gate 1	$f = 1\text{ MHz}$	2	2.8	3.6	pF
C_{ig2-ss}	input capacitance at gate 2	$f = 1\text{ MHz}$; (note 2)	–	–	7	pF
C_{oss}	output capacitance	$f = 1\text{ MHz}$	–	1.6	2.5	pF
C_{rss}	reverse transfer capacitance	$f = 1\text{ MHz}$	–	30	50	fF
F	noise figure	$f = 800\text{ MHz}$; $Y_S = Y_{S\text{ opt}}$	–	2	2.8	dB
X_{mod}	cross-modulation	$f_w = 50\text{ MHz}$; $f_{unw} = 60\text{ MHz}$; (note 3) input level for $k = 1\%$ at 0 dB AGC input level for $k = 1\%$ at 40 dB AGC	85 100	– –	– –	dB μ V dB μ V

Notes

- Not used MOS-FET: $V_{G1-S} = 0$; $V_{DS} = 0$.
- Gate 2 capacitance of both MOS-FETs.
- Measured in test circuit of Fig.20.

Dual N-channel dual gate MOS-FETs

BF1102; BF1102R

ALL GRAPHS FOR ONE MOS-FET

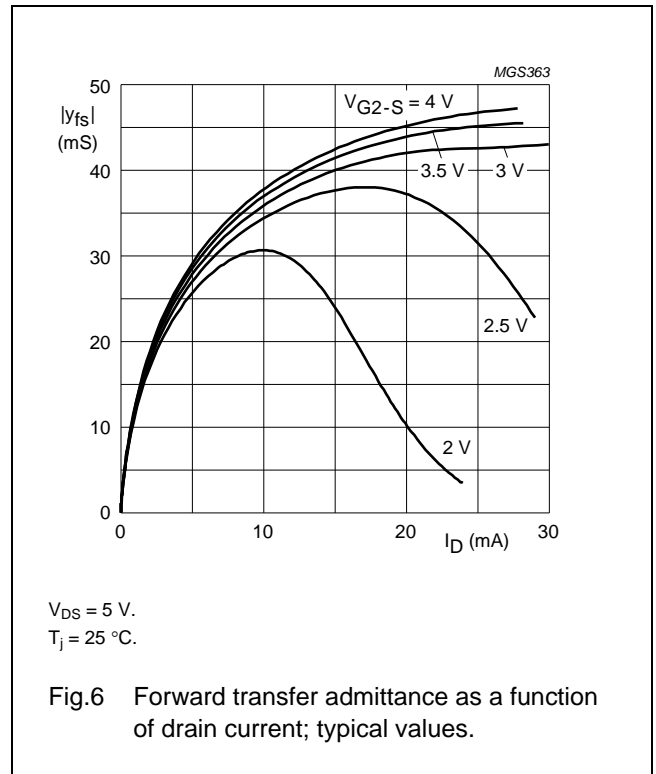
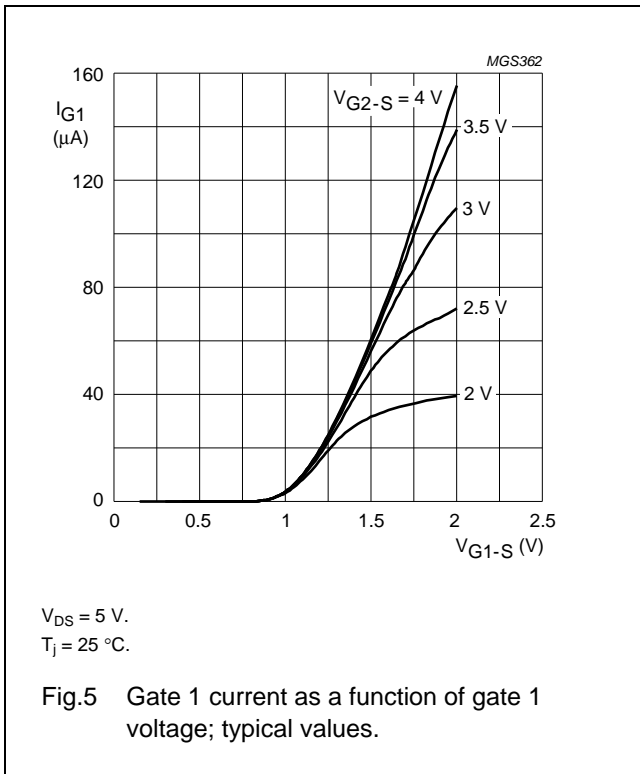
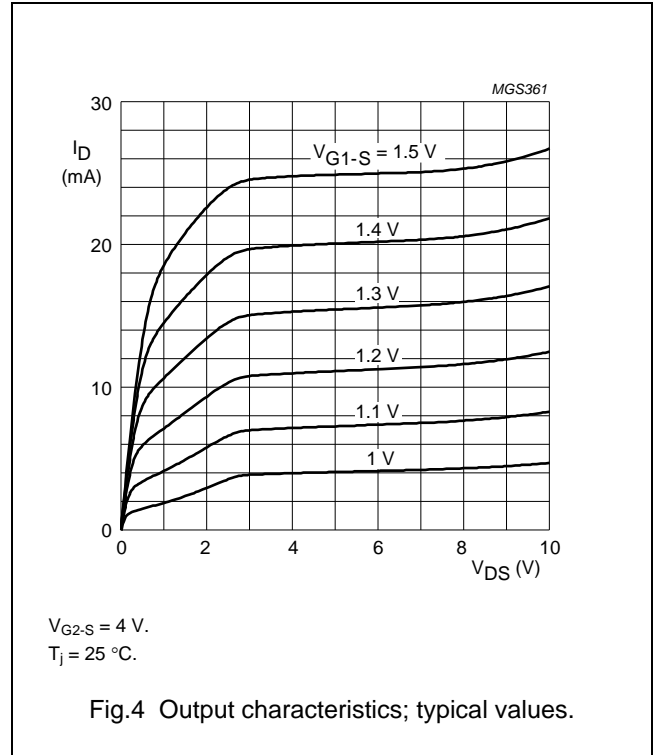
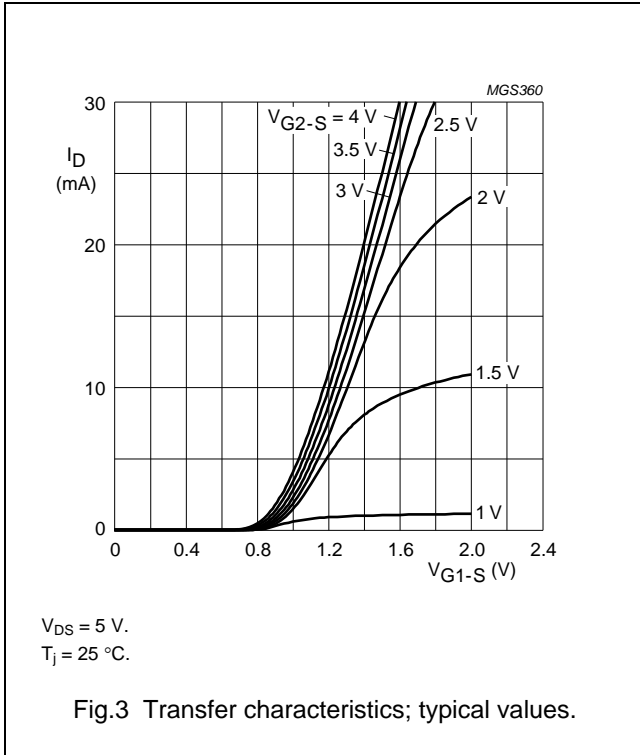

Dual N-channel dual gate MOS-FETs

BF1102; BF1102R

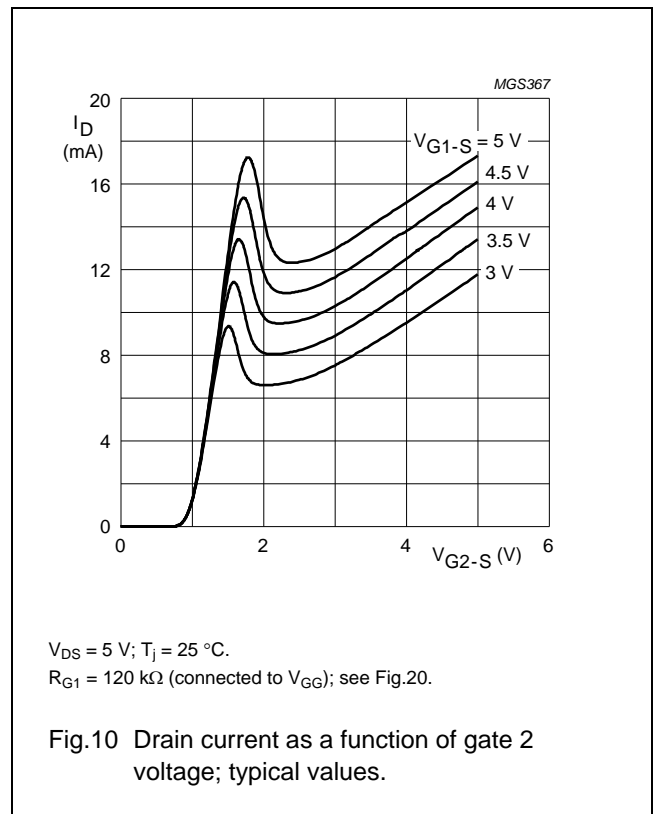
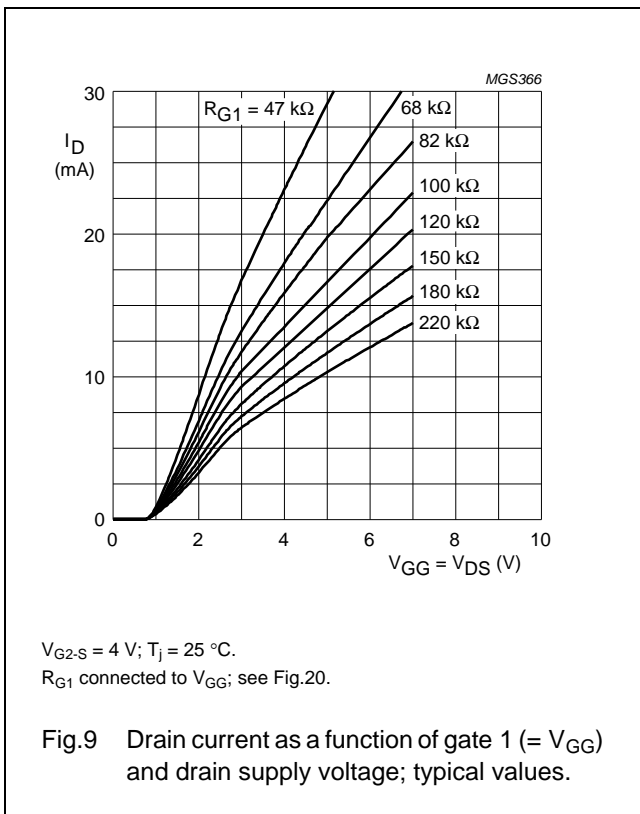
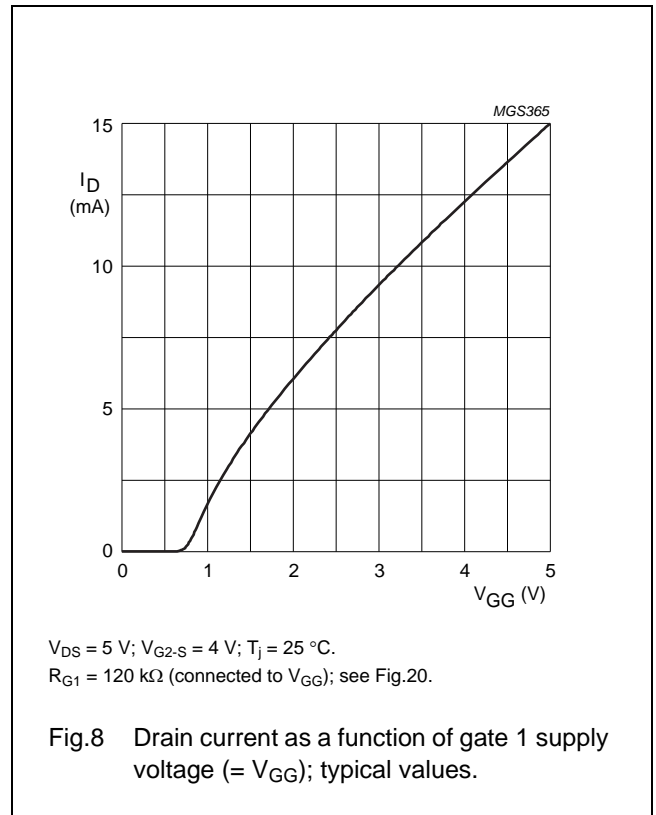
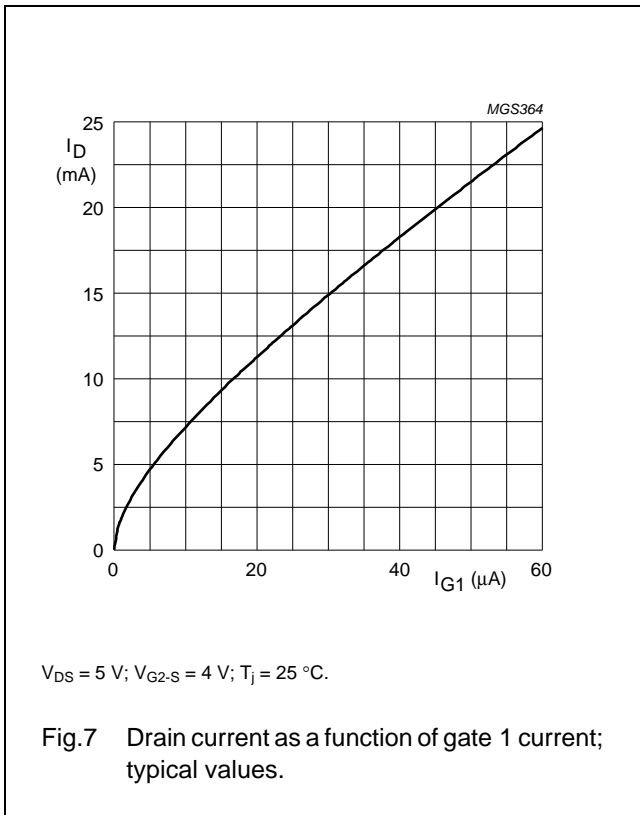

Dual N-channel dual gate MOS-FETs

BF1102; BF1102R

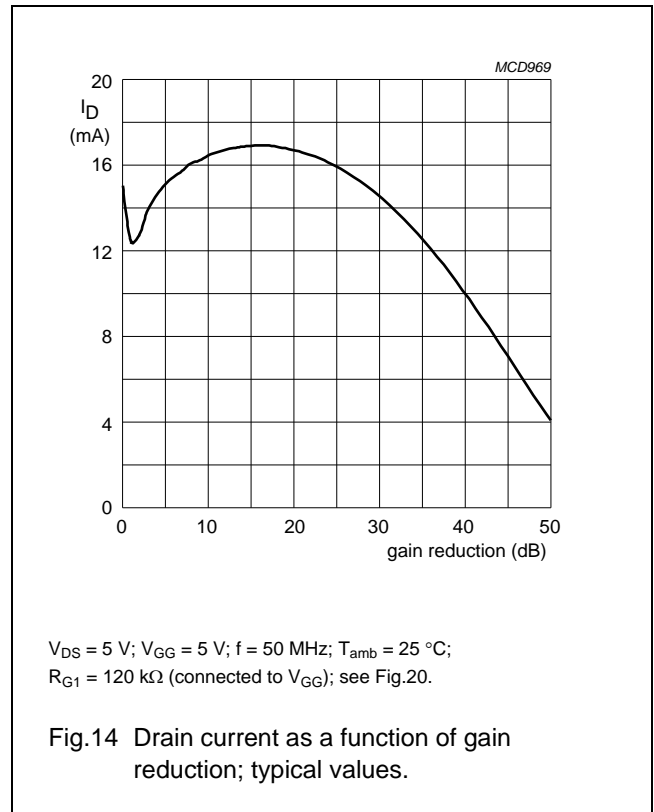
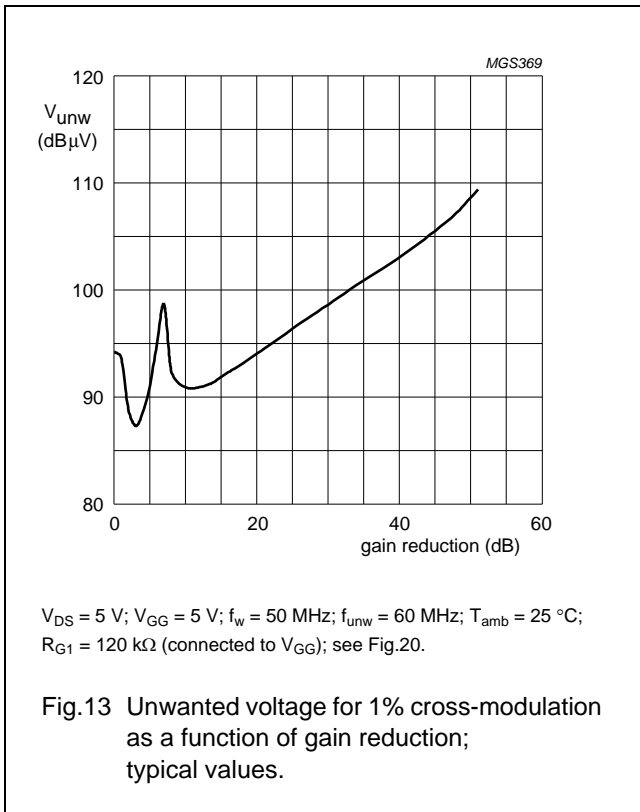
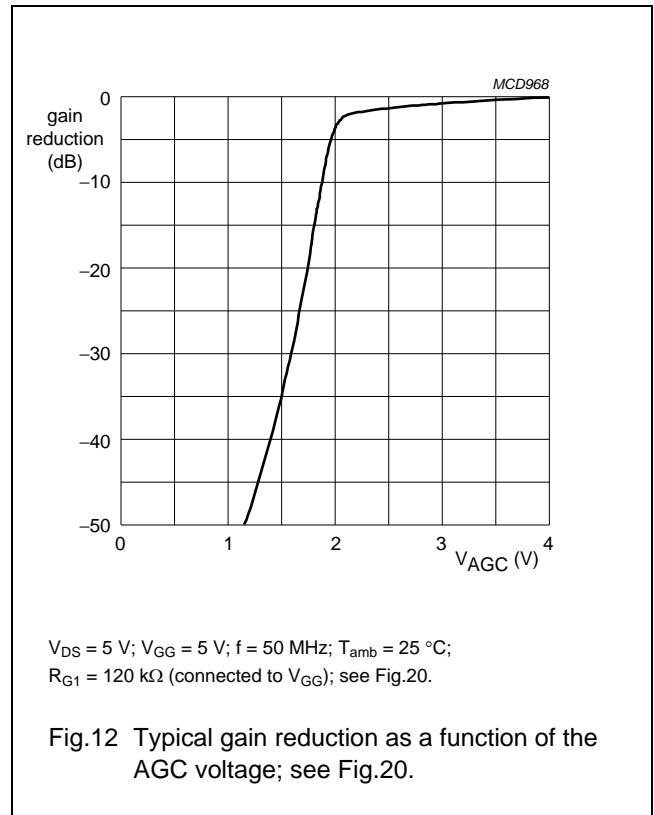
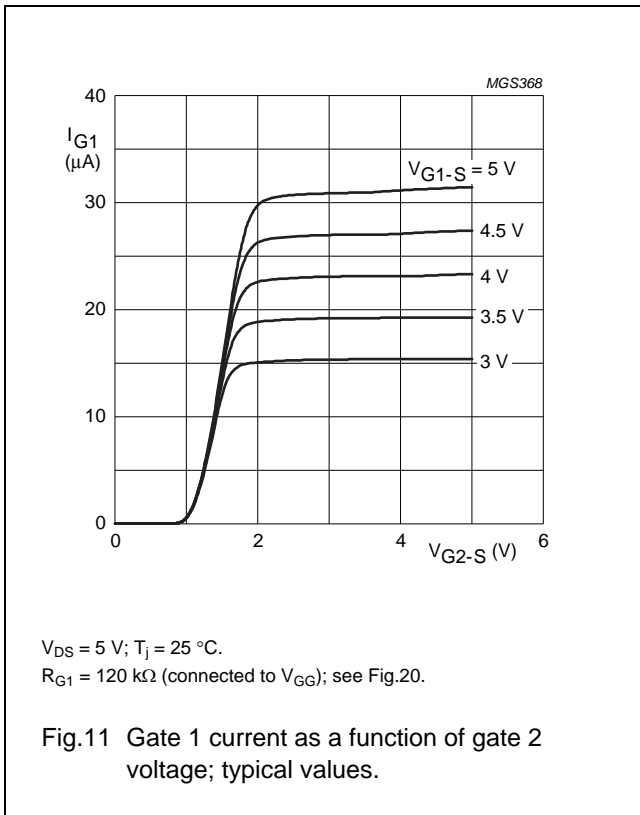

Dual N-channel dual gate MOS-FETs

BF1102; BF1102R

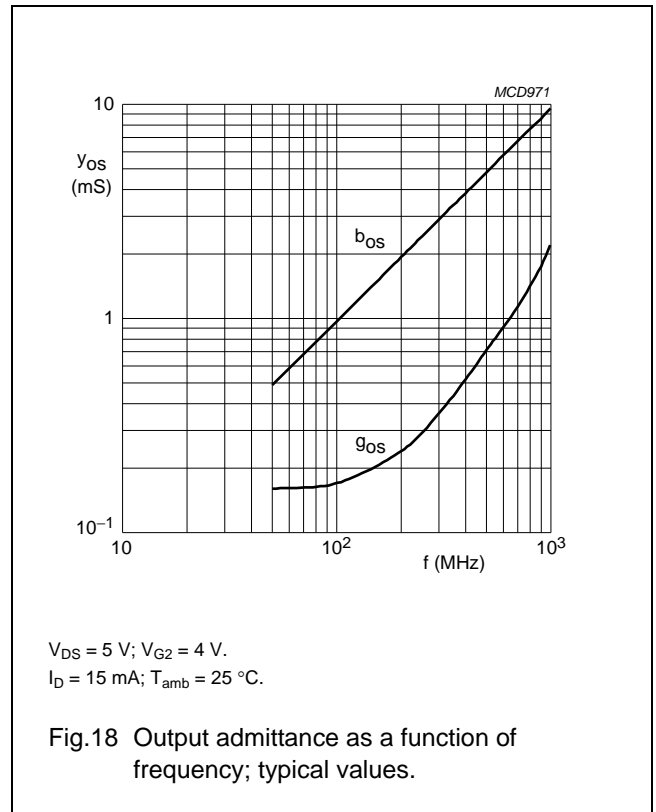
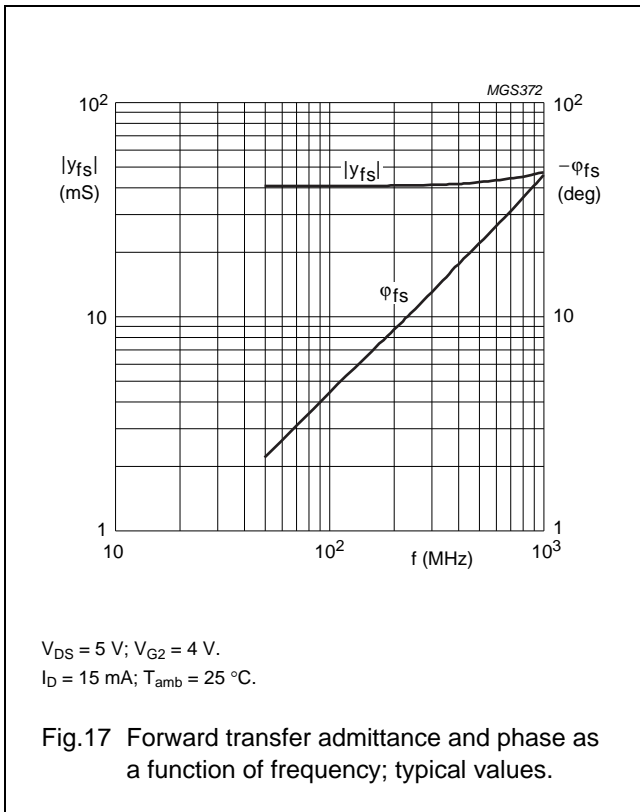
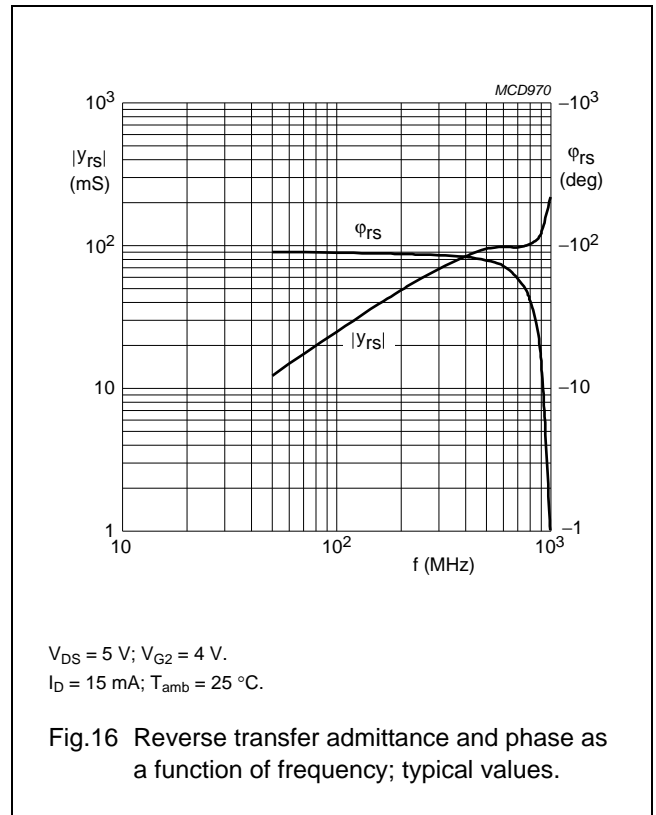
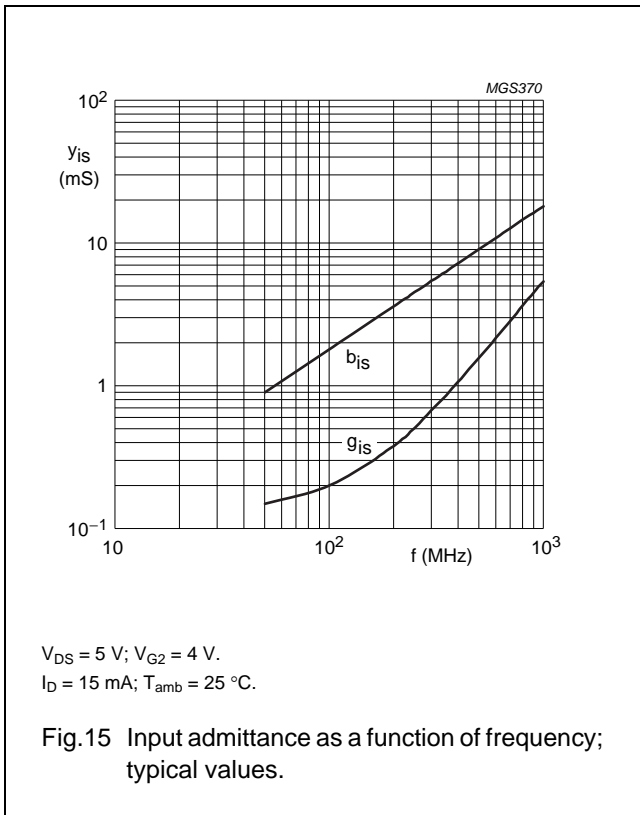

Dual N-channel dual gate MOS-FETs

BF1102; BF1102R

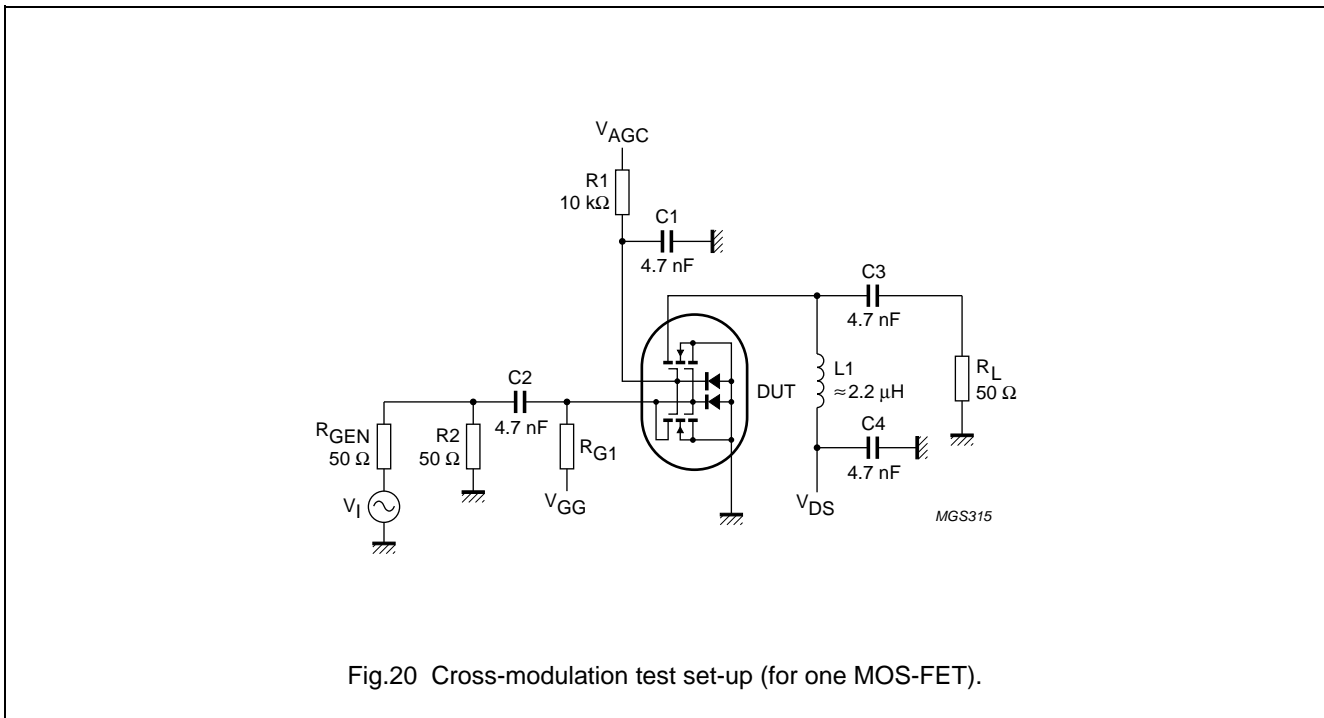
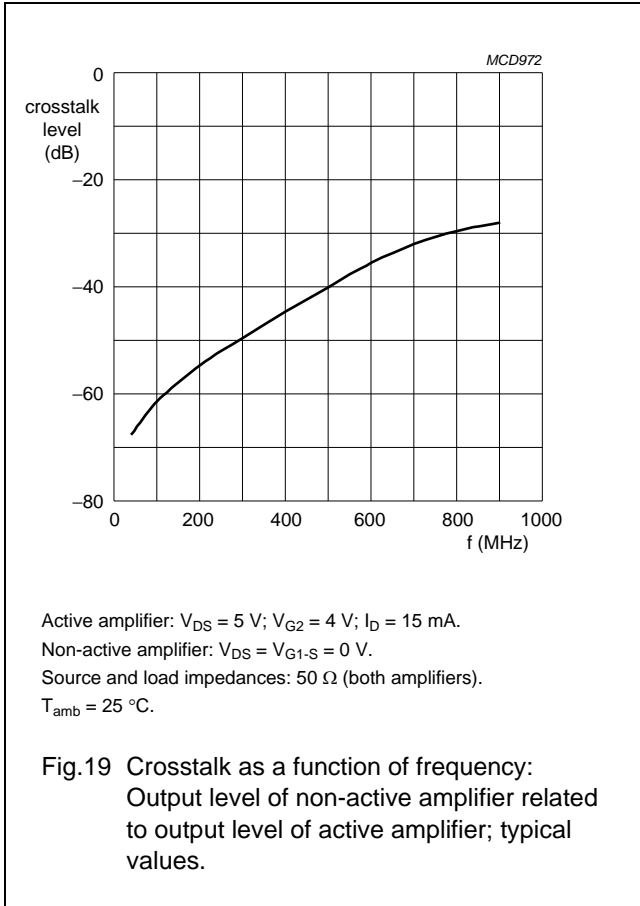

Dual N-channel dual gate MOS-FETs

BF1102; BF1102R

Table 1 Scattering parameters: $V_{DS} = 5\text{ V}$; $V_{G2-S} = 4\text{ V}$; $I_D = 15\text{ mA}$; $T_{amb} = 25\text{ °C}$

f (MHz)	S ₁₁		S ₂₁		S ₁₂		S ₂₂	
	MAGNITUDE (ratio)	ANGLE (deg)	MAGNITUDE (ratio)	ANGLE (deg)	MAGNITUDE (ratio)	ANGLE (deg)	MAGNITUDE (ratio)	ANGLE (deg)
50	0.987	-5.6	4.069	173.5	0.001	95.4	0.986	-3.0
100	0.981	-11.1	4.042	167.0	0.002	81.3	0.983	-6.0
200	0.961	-21.9	3.926	154.4	0.005	75.8	0.976	-12.0
300	0.933	-32.1	3.778	142.4	0.006	69.6	0.960	-17.7
400	0.899	-42.0	3.593	130.6	0.007	65.6	0.945	-23.2
500	0.867	-51.1	3.412	119.6	0.007	64.4	0.928	-29.1
600	0.834	-59.9	3.216	109.2	0.007	67.5	0.914	-34.1
700	0.805	-67.9	3.010	99.0	0.006	78.7	0.901	-39.8
800	0.779	-75.7	2.804	89.2	0.007	92.7	0.886	-45.1
900	0.758	-82.1	2.656	80.3	0.007	120.7	0.889	-49.7
1000	0.740	-89.0	2.509	69.9	0.009	125.5	0.890	-55.7

Table 2 Noise data: $V_{DS} = 5\text{ V}$; $V_{G2-S} = 4\text{ V}$; $I_D = 15\text{ mA}$; $T_{amb} = 25\text{ °C}$

f (MHz)	F _{min} (dB)	Γ _{opt}		R _n (Ω)
		(ratio)	(deg)	
800	2	0.621	61.61	25.85

Dual N-channel dual gate MOS-FETs

BF1102; BF1102R

PACKAGE OUTLINE

Plastic surface-mounted package; 6 leads

SOT363

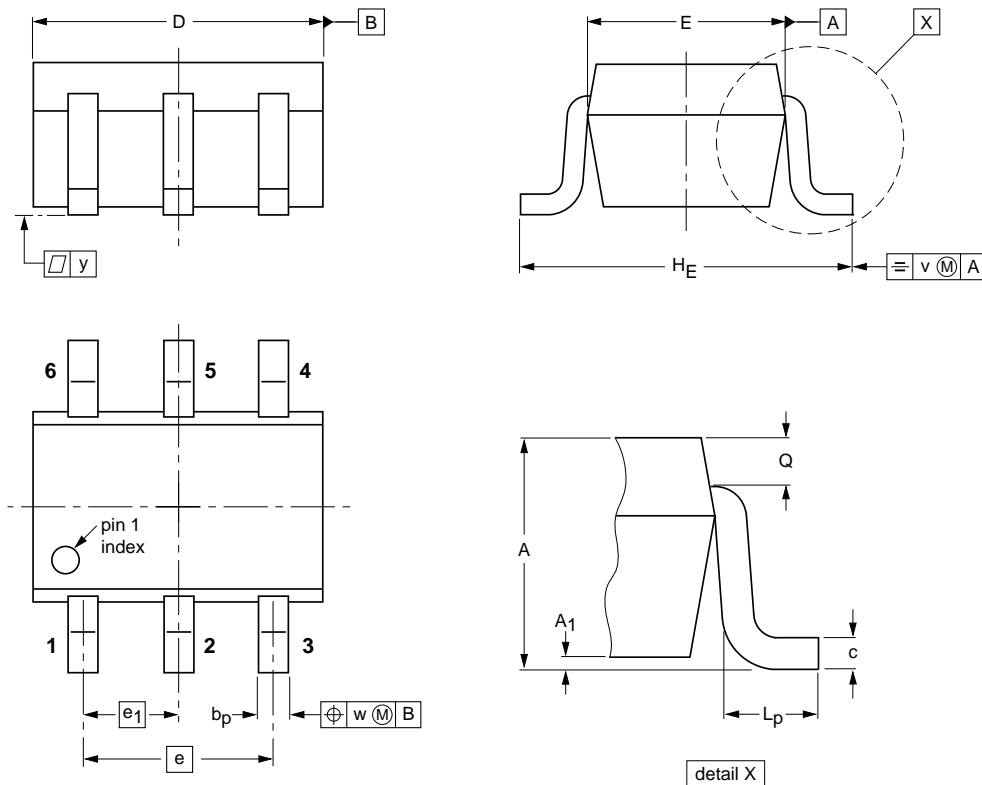

DIMENSIONS (mm are the original dimensions)

UNIT	A	A ₁ max	b _p	c	D	E	e	e ₁	H _E	L _p	Q	v	w	y
mm	1.1 0.8	0.1	0.30 0.20	0.25 0.10	2.2 1.8	1.35 1.15	1.3	0.65	2.2 2.0	0.45 0.15	0.25 0.15	0.2	0.2	0.1

OUTLINE VERSION	REFERENCES				EUROPEAN PROJECTION	ISSUE DATE
	IEC	JEDEC	JEITA			
SOT363			SC-88			04-11-08 06-03-16

Dual N-channel dual gate MOS-FETs

BF1102; BF1102R

DATA SHEET STATUS

DOCUMENT STATUS ⁽¹⁾	PRODUCT STATUS ⁽²⁾	DEFINITION
Objective data sheet	Development	This document contains data from the objective specification for product development.
Preliminary data sheet	Qualification	This document contains data from the preliminary specification.
Product data sheet	Production	This document contains the product specification.

Notes

1. Please consult the most recently issued document before initiating or completing a design.
2. The product status of device(s) described in this document may have changed since this document was published and may differ in case of multiple devices. The latest product status information is available on the Internet at URL <http://www.nxp.com>.

DEFINITIONS

Product specification — The information and data provided in a Product data sheet shall define the specification of the product as agreed between NXP Semiconductors and its customer, unless NXP Semiconductors and customer have explicitly agreed otherwise in writing. In no event however, shall an agreement be valid in which the NXP Semiconductors product is deemed to offer functions and qualities beyond those described in the Product data sheet.

DISCLAIMERS

Limited warranty and liability — Information in this document is believed to be accurate and reliable. However, NXP Semiconductors does not give any representations or warranties, expressed or implied, as to the accuracy or completeness of such information and shall have no liability for the consequences of use of such information.

In no event shall NXP Semiconductors be liable for any indirect, incidental, punitive, special or consequential damages (including - without limitation - lost profits, lost savings, business interruption, costs related to the removal or replacement of any products or rework charges) whether or not such damages are based on tort (including negligence), warranty, breach of contract or any other legal theory.

Notwithstanding any damages that customer might incur for any reason whatsoever, NXP Semiconductors' aggregate and cumulative liability towards customer for the products described herein shall be limited in accordance with the *Terms and conditions of commercial sale* of NXP Semiconductors.

Right to make changes — NXP Semiconductors reserves the right to make changes to information published in this document, including without limitation specifications and product descriptions, at any time and without notice. This document supersedes and replaces all information supplied prior to the publication hereof.

Suitability for use — NXP Semiconductors products are not designed, authorized or warranted to be suitable for use in life support, life-critical or safety-critical systems or equipment, nor in applications where failure or malfunction of an NXP Semiconductors product can reasonably be expected to result in personal injury, death or severe property or environmental damage. NXP Semiconductors accepts no liability for inclusion and/or use of NXP Semiconductors products in such equipment or applications and therefore such inclusion and/or use is at the customer's own risk.

Applications — Applications that are described herein for any of these products are for illustrative purposes only. NXP Semiconductors makes no representation or warranty that such applications will be suitable for the specified use without further testing or modification.

Customers are responsible for the design and operation of their applications and products using NXP Semiconductors products, and NXP Semiconductors accepts no liability for any assistance with applications or customer product design. It is customer's sole responsibility to determine whether the NXP Semiconductors product is suitable and fit for the customer's applications and products planned, as well as for the planned application and use of customer's third party customer(s). Customers should provide appropriate design and operating safeguards to minimize the risks associated with their applications and products.

Dual N-channel dual gate MOS-FETs

BF1102; BF1102R

NXP Semiconductors does not accept any liability related to any default, damage, costs or problem which is based on any weakness or default in the customer's applications or products, or the application or use by customer's third party customer(s). Customer is responsible for doing all necessary testing for the customer's applications and products using NXP Semiconductors products in order to avoid a default of the applications and the products or of the application or use by customer's third party customer(s). NXP does not accept any liability in this respect.

Limiting values — Stress above one or more limiting values (as defined in the Absolute Maximum Ratings System of IEC 60134) will cause permanent damage to the device. Limiting values are stress ratings only and (proper) operation of the device at these or any other conditions above those given in the Recommended operating conditions section (if present) or the Characteristics sections of this document is not warranted. Constant or repeated exposure to limiting values will permanently and irreversibly affect the quality and reliability of the device.

Terms and conditions of commercial sale — NXP Semiconductors products are sold subject to the general terms and conditions of commercial sale, as published at <http://www.nxp.com/profile/terms>, unless otherwise agreed in a valid written individual agreement. In case an individual agreement is concluded only the terms and conditions of the respective agreement shall apply. NXP Semiconductors hereby expressly objects to applying the customer's general terms and conditions with regard to the purchase of NXP Semiconductors products by customer.

No offer to sell or license — Nothing in this document may be interpreted or construed as an offer to sell products that is open for acceptance or the grant, conveyance or implication of any license under any copyrights, patents or other industrial or intellectual property rights.

Export control — This document as well as the item(s) described herein may be subject to export control regulations. Export might require a prior authorization from national authorities.

Quick reference data — The Quick reference data is an extract of the product data given in the Limiting values and Characteristics sections of this document, and as such is not complete, exhaustive or legally binding.

Non-automotive qualified products — Unless this data sheet expressly states that this specific NXP Semiconductors product is automotive qualified, the product is not suitable for automotive use. It is neither qualified nor tested in accordance with automotive testing or application requirements. NXP Semiconductors accepts no liability for inclusion and/or use of non-automotive qualified products in automotive equipment or applications.

In the event that customer uses the product for design-in and use in automotive applications to automotive specifications and standards, customer (a) shall use the product without NXP Semiconductors' warranty of the product for such automotive applications, use and specifications, and (b) whenever customer uses the product for automotive applications beyond NXP Semiconductors' specifications such use shall be solely at customer's own risk, and (c) customer fully indemnifies NXP Semiconductors for any liability, damages or failed product claims resulting from customer design and use of the product for automotive applications beyond NXP Semiconductors' standard warranty and NXP Semiconductors' product specifications.

NXP Semiconductors

provides High Performance Mixed Signal and Standard Product solutions that leverage its leading RF, Analog, Power Management, Interface, Security and Digital Processing expertise

Customer notification

This data sheet was changed to reflect the new company name NXP Semiconductors, including new legal definitions and disclaimers. No changes were made to the technical content, except for package outline drawings which were updated to the latest version.

Contact information

For additional information please visit: <http://www.nxp.com>

For sales offices addresses send e-mail to: salesaddresses@nxp.com

© NXP B.V. 2010

All rights are reserved. Reproduction in whole or in part is prohibited without the prior written consent of the copyright owner.

The information presented in this document does not form part of any quotation or contract, is believed to be accurate and reliable and may be changed without notice. No liability will be accepted by the publisher for any consequence of its use. Publication thereof does not convey nor imply any license under patent- or other industrial or intellectual property rights.

Looking for pricing, stock, or lifecycle information?

Click below to explore more details on WIN SOURCE:

- [View BF1102R,115 on WIN SOURCE](#)
- [NXP / Nexperia Information](#)

Optimize Your Supply Chain with WIN SOURCE Solutions

- ✓ Global Sourcing Solution
- ✓ Obsolete Management
- ✓ Cost Control Management
- ✓ Shortage Management
- ✓ Alternative Solution
- ✓ Excess Inventory Management