

BF1207

Dual N-channel dual gate MOSFET

Rev. 01 — 28 July 2005

Product data sheet

1. Product profile

1.1 General description

The BF1207 is a combination of two dual gate MOSFET amplifiers with shared source and gate2 leads and an integrated switch.

The source and substrate are interconnected. Internal bias circuits enable Direct Current (DC) stabilization and a very good cross-modulation performance during Automatic Gain Control (AGC). Integrated diodes between the gates and source protect against excessive input voltage surges. The BF1207 has a SOT363 micro-miniature plastic package.

CAUTION



This device is sensitive to ElectroStatic Discharge (ESD). Therefore care should be taken during transport and handling.

1.2 Features

- Two low noise gain controlled amplifiers in a single package. One with a fully integrated bias and one with partly integrated bias
- Internal switch to save external components
- Superior cross-modulation performance during AGC
- High forward transfer admittance
- High forward transfer admittance to input capacitance ratio

1.3 Applications

- Gain controlled low noise amplifiers for Very High Frequency (VHF) and Ultra High Frequency (UHF) applications with 5 V supply voltage, such as digital and analog television tuners and professional communication equipment

PHILIPS

1.4 Quick reference data

Table 1: Quick reference data
Per MOSFET unless otherwise specified.

Symbol	Parameter	Conditions	Min	Typ	Max	Unit
V_{DS}	drain-source voltage	DC	-	-	6	V
I_D	drain current	DC	-	-	30	mA
P_{tot}	total power dissipation	$T_{sp} \leq 107\text{ }^\circ\text{C}$	[1]	-	180	mW
$ y_{fs} $	forward transfer admittance	$f = 1\text{ MHz}$				
		amplifier A; $I_D = 18\text{ mA}$	25	30	40	mS
		amplifier B; $I_D = 14\text{ mA}$	26	31	41	mS
$C_{iss(G1)}$	input capacitance at gate1	$f = 100\text{ MHz}$				
		amplifier A	-	2.2	2.7	pF
		amplifier B	-	1.9	2.4	pF
C_{rss}	reverse transfer capacitance	$f = 100\text{ MHz}$	-	20	-	fF
NF	noise figure	amplifier A; $f = 400\text{ MHz}$	-	1.3	-	dB
		amplifier B; $f = 800\text{ MHz}$	-	1.4	-	dB
Xmod	cross-modulation	input level for $k = 1\%$ at 40 dB AGC				
		amplifier A	100	105	-	dB μ V
		amplifier B	100	103	-	dB μ V
T_j	junction temperature		-	-	150	$^\circ\text{C}$

[1] T_{sp} is the temperature at the soldering point of the source lead.

2. Pinning information

Table 2: Discrete pinning

Pin	Description	Simplified outline	Symbol
1	drain (AMP A)		<p style="text-align: center;">sym108</p>
2	source		
3	drain (AMP B)		
4	gate1 (AMP B)		
5	gate2		
6	gate1 (AMP A)		

3. Ordering information

Table 3: Ordering information

Type number	Package		
	Name	Description	Version
BF1207	-	plastic surface mounted package; 6 leads	SOT363

4. Marking

Table 4: Marking

Type number	Marking code [1]
BF1207	M2*

[1] * = p: Made in Hong Kong.

* = t: Made in Malaysia.

* = W: Made in China.

5. Limiting values

Table 5: Limiting values

In accordance with the Absolute Maximum Rating System (IEC 60134).

Symbol	Parameter	Conditions	Min	Max	Unit
Per MOSFET					
V_{DS}	drain-source voltage	DC	-	6	V
I_D	drain current	DC	-	30	mA
I_{G1}	gate1 current		-	±10	mA
I_{G2}	gate2 current		-	±10	mA
P_{tot}	total power dissipation	$T_{sp} \leq 107\text{ °C}$ [1]	-	180	mW
T_{stg}	storage temperature		-65	+150	°C
T_j	junction temperature		-	150	°C

[1] T_{sp} is the temperature at the soldering point of the source lead.

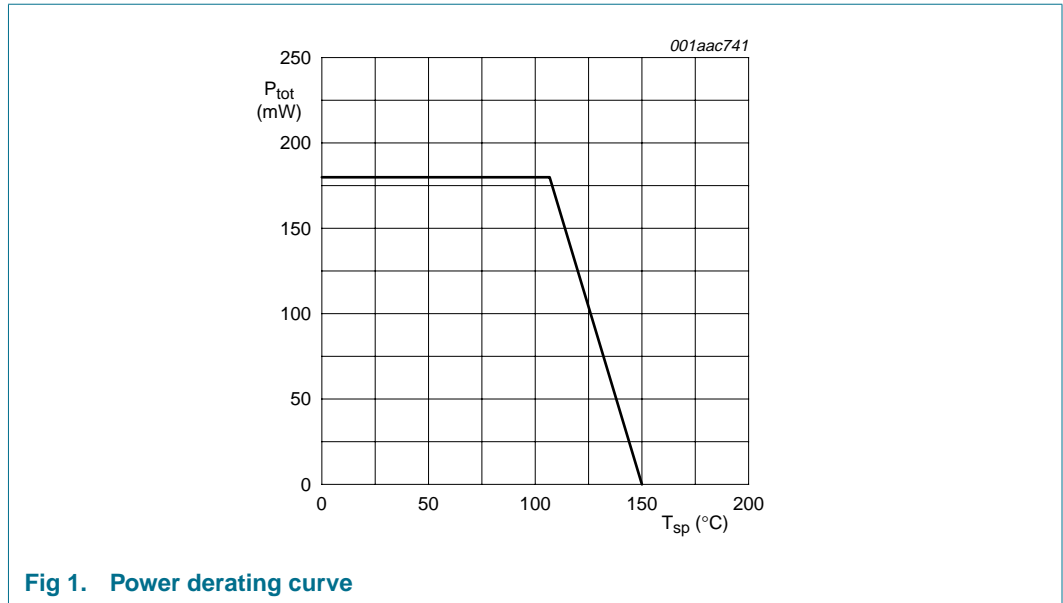

Fig 1. Power derating curve

6. Thermal characteristics

Table 6: Thermal characteristics

Symbol	Parameter	Conditions	Typ	Unit
R _{th(j-sp)}	thermal resistance from junction to soldering point		240	K/W

7. Static characteristics

Table 7: Static characteristics

T_j = 25 °C.

Symbol	Parameter	Conditions	Min	Typ	Max	Unit
Per MOSFET; unless otherwise specified						
V _{(BR)DSS}	drain-source breakdown voltage	V _{G1-S} = V _{G2-S} = 0 V; I _D = 10 μA				
		amplifier A	6	-	-	V
		amplifier B	6	-	-	V
V _{(BR)G1-SS}	gate1-source breakdown voltage	V _{GS} = V _{DS} = 0 V; I _{G1-S} = 10 mA	6	-	10	V
V _{(BR)G2-SS}	gate2-source breakdown voltage	V _{GS} = V _{DS} = 0 V; I _{G2-S} = 10 mA	6	-	10	V
V _{F(S-G1)}	forward source-gate1 voltage	V _{G2-S} = V _{DS} = 0 V; I _{S-G1} = 10 mA	0.5	-	1.5	V
V _{F(S-G2)}	forward source-gate2 voltage	V _{G1-S} = V _{DS} = 0 V; I _{S-G2} = 10 mA	0.5	-	1.5	V
V _{G1-S(th)}	gate1-source threshold voltage	V _{DS} = 5 V; V _{G2-S} = 4 V; I _D = 100 μA	0.3	-	1.0	V
V _{G2-S(th)}	gate2-source threshold voltage	V _{DS} = 5 V; V _{G1-S} = 5 V; I _D = 100 μA	0.4	-	1.0	V
I _{DSX}	drain-source current	V _{G2-S} = 4 V; V _{DS} = 5 V; R _{G1} = 68 kΩ				
		amplifier A	[1] 13	-	23	mA
		amplifier B	[2] 9	-	19	mA

Table 7: Static characteristics ...continued
 $T_j = 25\text{ }^\circ\text{C}$.

Symbol	Parameter	Conditions	Min	Typ	Max	Unit
I_{G1-S}	gate1 cut-off current	$V_{G2-S} = V_{DS(A)} = 0\text{ V}$	-	-	-	-
		amplifier A; $V_{G1-S(A)} = 5\text{ V}$; $V_{DS(B)} = 0\text{ V}$	-	-	50	nA
		amplifier B; $V_{G1-S(A)} = 0\text{ V}$; $I_{D(B)} = 0\text{ A}$	-	-	50	nA
I_{G2-S}	gate2 cut-off current	$V_{G2-S} = 4\text{ V}$; $V_{G1-S} = V_{DS(A)} = V_{DS(B)} = 0\text{ V}$;	-	-	20	nA

- [1] R_{G1} connects gate1 (A) to $V_{GG} = 5\text{ V}$ (see Figure 3).
- [2] R_{G1} connects gate1 (B) to $V_{GG} = 0\text{ V}$ (see Figure 3).

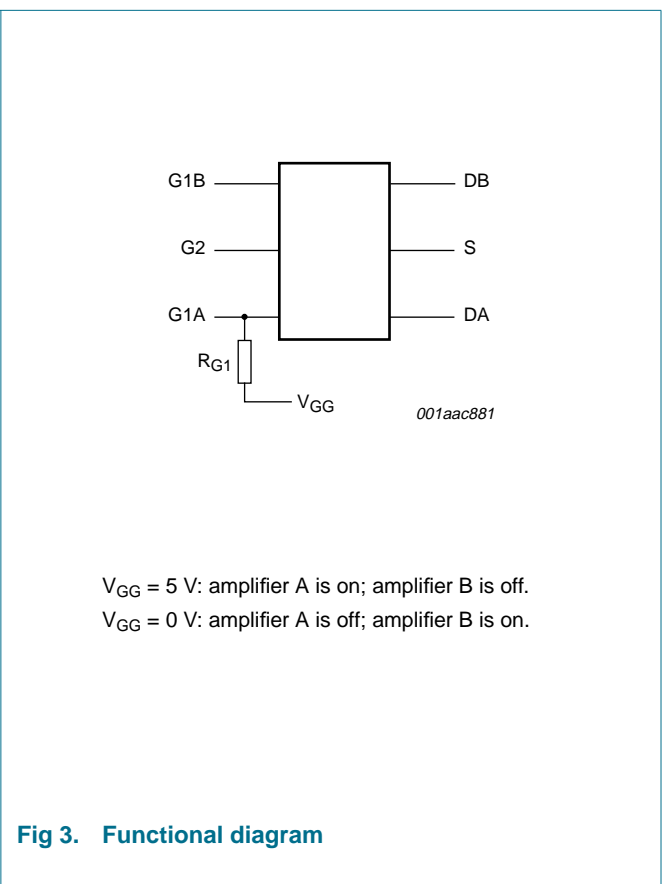
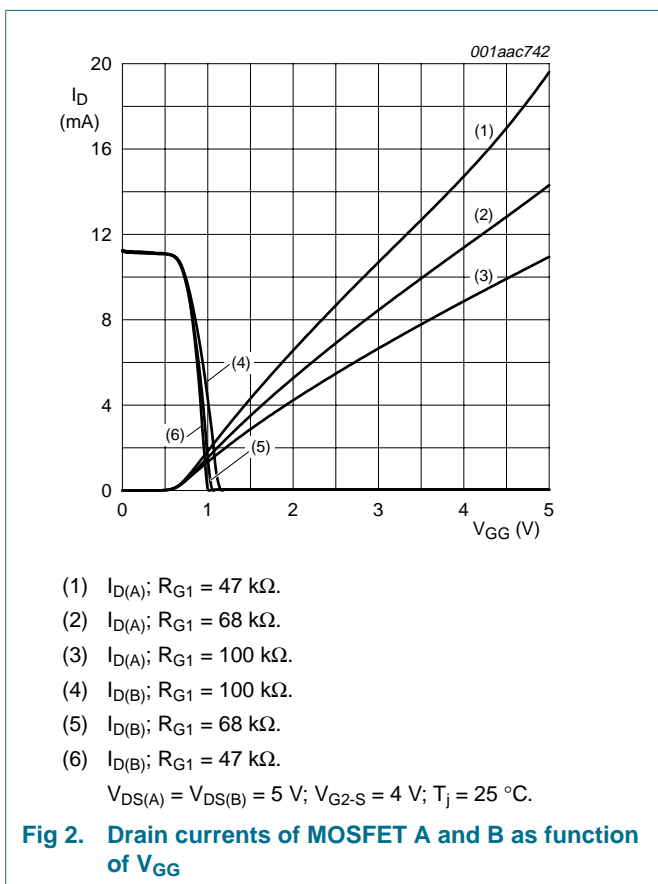

8. Dynamic characteristics

8.1 Dynamic characteristics for amplifier A

Table 8: Dynamic characteristics for amplifier A

Common source; $T_{amb} = 25\text{ °C}$; $V_{G2-S} = 4\text{ V}$; $V_{DS} = 5\text{ V}$; $I_D = 18\text{ mA}$. [\[1\]](#)

Symbol	Parameter	Conditions	Min	Typ	Max	Unit
$ y_{fs} $	forward transfer admittance	$T_j = 25\text{ °C}$	25	30	40	mS
$C_{iss(G1)}$	input capacitance at gate1	$f = 100\text{ MHz}$	-	2.2	2.7	pF
$C_{iss(G2)}$	input capacitance at gate2	$f = 1\text{ MHz}$	-	3.5	-	pF
C_{oss}	output capacitance	$f = 100\text{ MHz}$	-	0.9	-	pF
C_{rss}	reverse transfer capacitance	$f = 100\text{ MHz}$	-	20	-	fF
G_{tr}	power gain	$B_S = B_{S(opt)}$; $B_L = B_{L(opt)}$				
		$f = 200\text{ MHz}$; $G_S = 2\text{ mS}$; $G_L = 0.5\text{ mS}$	30	34	38	dB
		$f = 400\text{ MHz}$; $G_S = 2\text{ mS}$; $G_L = 1\text{ mS}$	26	30	34	dB
		$f = 800\text{ MHz}$; $G_S = 3.3\text{ mS}$; $G_L = 1\text{ mS}$	21	25	29	dB
NF	noise figure	$f = 11\text{ MHz}$; $G_S = 20\text{ mS}$; $B_S = 0\text{ S}$	-	3.0	-	dB
		$f = 400\text{ MHz}$; $Y_S = Y_{S(opt)}$	-	1.3	-	dB
		$f = 800\text{ MHz}$; $Y_S = Y_{S(opt)}$	-	1.4	-	dB
Xmod	cross-modulation	input level for $k = 1\%$; $f_w = 50\text{ MHz}$; $f_{unw} = 60\text{ MHz}$	[2]			
		at 0 dB AGC	90	-	-	dB μ V
		at 10 dB AGC	-	90	-	dB μ V
		at 20 dB AGC	-	99	-	dB μ V
		at 40 dB AGC	100	105	-	dB μ V

[1] For the MOSFET not in use: $V_{G1-S(B)} = 0\text{ V}$; $V_{DS(B)} = 0\text{ V}$.

[2] Measured in [Figure 29](#) test circuit.

8.1.1 Graphs for amplifier A

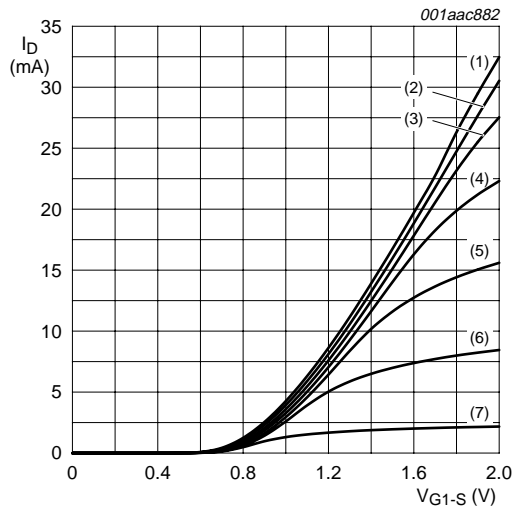

- (1) $V_{G2-S} = 4 \text{ V.}$
 - (2) $V_{G2-S} = 3.5 \text{ V.}$
 - (3) $V_{G2-S} = 3 \text{ V.}$
 - (4) $V_{G2-S} = 2.5 \text{ V.}$
 - (5) $V_{G2-S} = 2 \text{ V.}$
 - (6) $V_{G2-S} = 1.5 \text{ V.}$
 - (7) $V_{G2-S} = 1 \text{ V.}$
- $V_{DS(A)} = 5 \text{ V; } T_j = 25 \text{ }^\circ\text{C.}$

Fig 4. Amplifier A: transfer characteristics; typical values

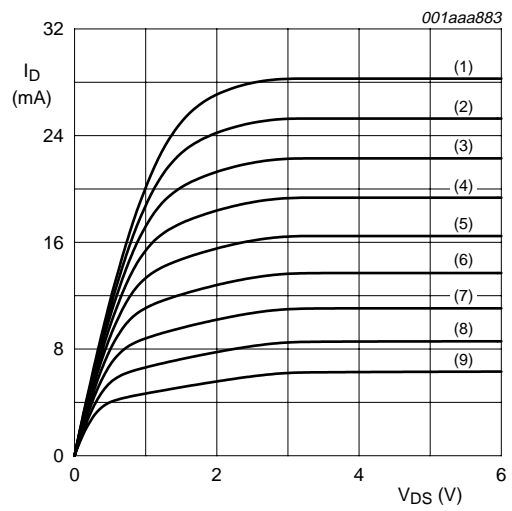

- (1) $V_{G1-S(A)} = 1.9 \text{ V.}$
 - (2) $V_{G1-S(A)} = 1.8 \text{ V.}$
 - (3) $V_{G1-S(A)} = 1.7 \text{ V.}$
 - (4) $V_{G1-S(A)} = 1.6 \text{ V.}$
 - (5) $V_{G1-S(A)} = 1.5 \text{ V.}$
 - (6) $V_{G1-S(A)} = 1.4 \text{ V.}$
 - (7) $V_{G1-S(A)} = 1.3 \text{ V.}$
 - (8) $V_{G1-S(A)} = 1.2 \text{ V.}$
 - (9) $V_{G1-S(A)} = 1.1 \text{ V.}$
- $V_{DS(A)} = 5 \text{ V; } V_{G2-S} = 4 \text{ V; } T_j = 25 \text{ }^\circ\text{C.}$

Fig 5. Amplifier A: output characteristics; typical values

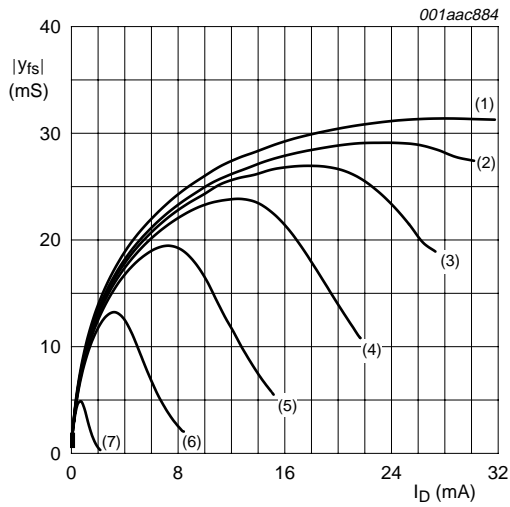

- (1) $V_{G2-S} = 4 \text{ V}$.
 - (2) $V_{G2-S} = 3.5 \text{ V}$.
 - (3) $V_{G2-S} = 3 \text{ V}$.
 - (4) $V_{G2-S} = 2.5 \text{ V}$.
 - (5) $V_{G2-S} = 2 \text{ V}$.
 - (6) $V_{G2-S} = 1.5 \text{ V}$.
 - (7) $V_{G2-S} = 1 \text{ V}$.
- $V_{DS(A)} = 5 \text{ V}$; $T_j = 25 \text{ }^\circ\text{C}$.

Fig 6. Amplifier A: forward transfer admittance as a function of drain current; typical values

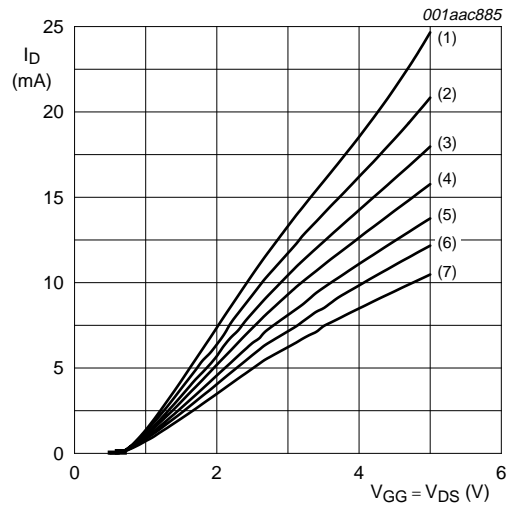

- (1) $R_{G1(A)} = 39 \text{ k}\Omega$.
 - (2) $R_{G1(A)} = 47 \text{ k}\Omega$.
 - (3) $R_{G1(A)} = 68 \text{ k}\Omega$.
 - (4) $R_{G1(A)} = 82 \text{ k}\Omega$.
 - (5) $R_{G1(A)} = 100 \text{ k}\Omega$.
 - (6) $R_{G1(A)} = 120 \text{ k}\Omega$.
 - (7) $R_{G1(A)} = 150 \text{ k}\Omega$.
- $V_{G2-S} = 4 \text{ V}$; $T_j = 25 \text{ }^\circ\text{C}$.

Fig 7. Amplifier A: drain current as a function of V_{DS} and V_{GG} ; typical values

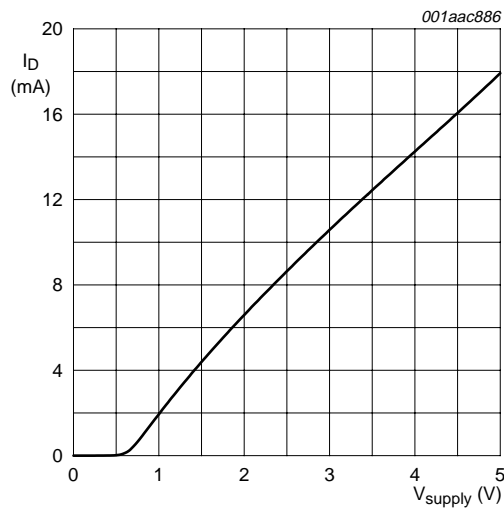

$V_{G2-S} = 4 \text{ V}$, $T_j = 25 \text{ }^\circ\text{C}$, $R_{G1(B)} = 68 \text{ k}\Omega$ (connected to ground); see [Figure 3](#).

Fig 8. Amplifier A: drain current of amplifier A as a function of supply voltage of A and B amplifier; typical values

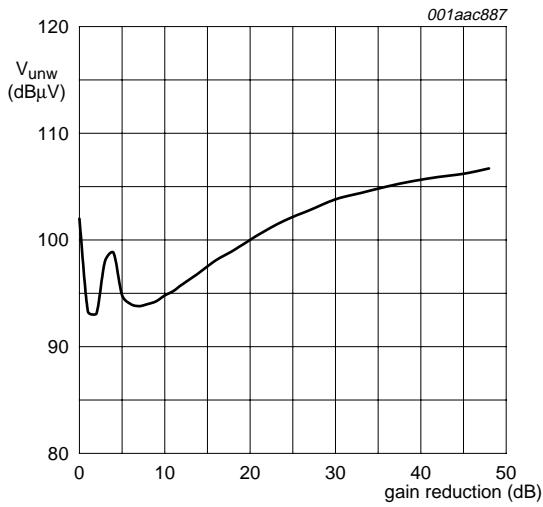

$V_{DS(A)} = V_{DS(B)} = 5\text{ V}$; $V_{G1-S(B)} = 0\text{ V}$; $f_w = 50\text{ MHz}$;
 $f_{unw} = 60\text{ MHz}$; $T_{amb} = 25\text{ °C}$; see [Figure 29](#).

Fig 9. Amplifier A: unwanted voltage for 1 % cross-modulation as a function of gain reduction; typical values

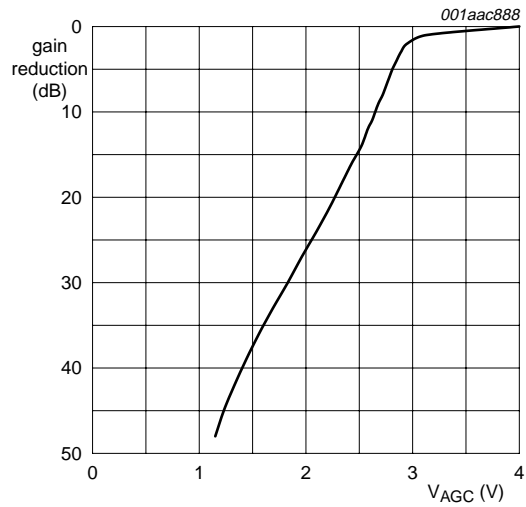

$V_{DS(A)} = V_{DS(B)} = 5\text{ V}$; $V_{G1-S(B)} = 0\text{ V}$; $f = 50\text{ MHz}$;
 see [Figure 29](#).

Fig 10. Amplifier A: gain reduction as a function of AGC voltage; typical values

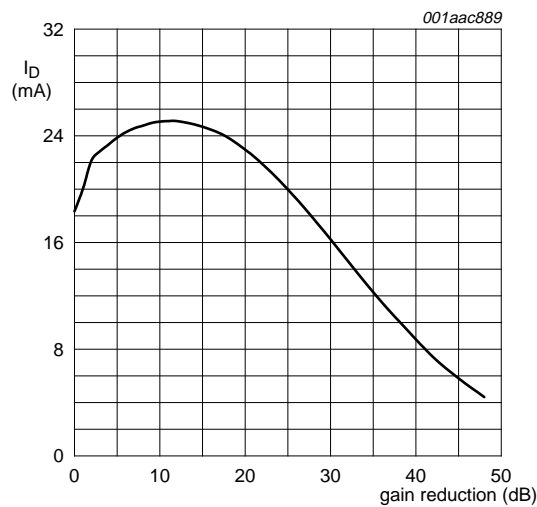

$V_{DS(A)} = V_{DS(B)} = 5\text{ V}$; $V_{G1-S(B)} = 0\text{ V}$; $f = 50\text{ MHz}$; $T_{amb} = 25\text{ °C}$; see [Figure 29](#).

Fig 11. Amplifier A: drain current as a function of gain reduction; typical values

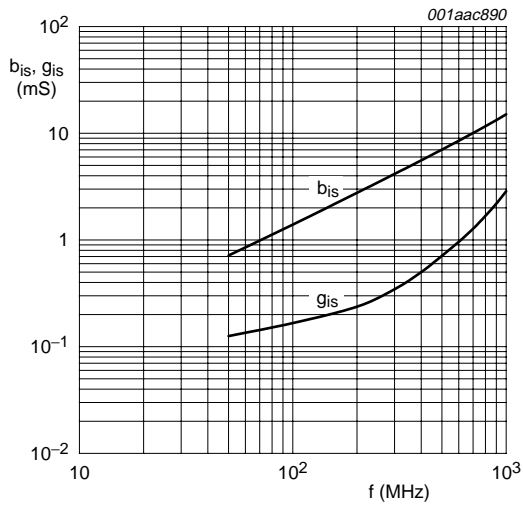

$V_{DS(A)} = 5\text{ V}; V_{G2-S} = 4\text{ V}; V_{DS(B)} = V_{G1-S(B)} = 0\text{ V}; I_{D(A)} = 18\text{ mA}.$

Fig 12. Amplifier A: input admittance as a function of frequency; typical values

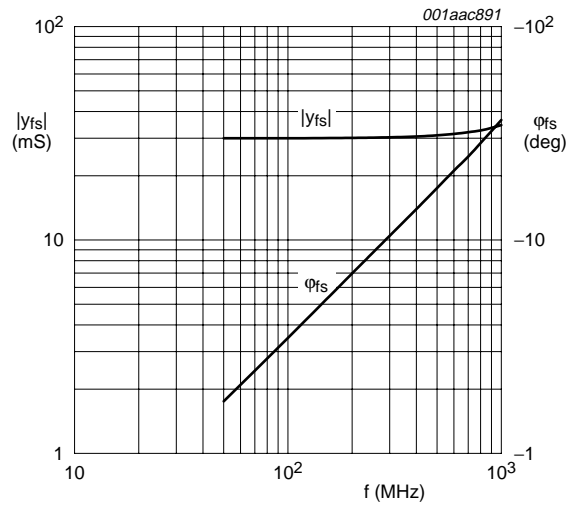

$V_{DS(A)} = 5\text{ V}; V_{G2-S} = 4\text{ V}; V_{DS(B)} = V_{G1-S(B)} = 0\text{ V}; I_{D(A)} = 18\text{ mA}.$

Fig 13. Amplifier A: forward transfer admittance and phase as a function of frequency; typical values

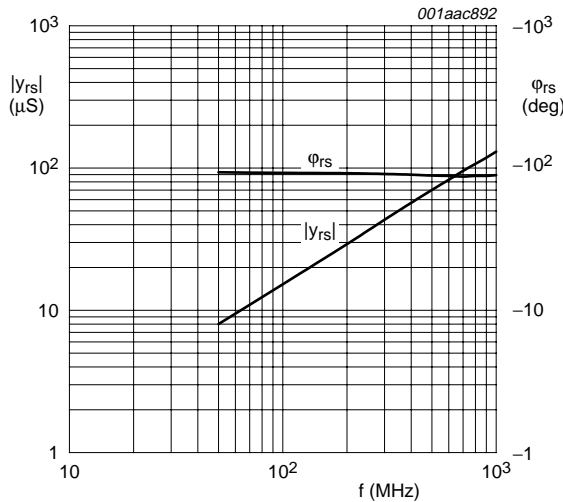

$V_{DS(A)} = 5\text{ V}; V_{G2-S} = 4\text{ V}; V_{DS(B)} = V_{G1-S(B)} = 0\text{ V}; I_{D(A)} = 18\text{ mA}.$

Fig 14. Amplifier A: reverse transfer admittance and phase as a function of frequency; typical values

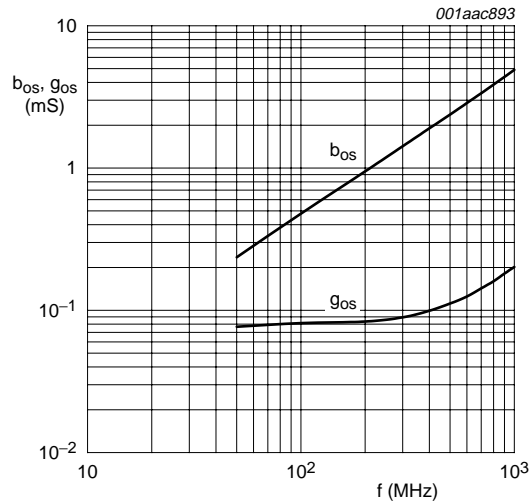

$V_{DS(A)} = 5\text{ V}; V_{G2-S} = 4\text{ V}; V_{DS(B)} = V_{G1-S(B)} = 0\text{ V}; I_{D(A)} = 18\text{ mA}.$

Fig 15. Amplifier A: output admittance as a function of frequency; typical values

8.1.2 Scattering parameters for amplifier A

Table 9: Scattering parameters for amplifier A

$V_{DS(A)} = 5\text{ V}$; $V_{G2-S} = 4\text{ V}$; $I_{D(A)} = 18\text{ mA}$; $V_{DS(B)} = 0\text{ V}$; $V_{G1-S(B)} = 0\text{ V}$; $T_{amb} = 25\text{ °C}$; typical values.

f (MHz)	S ₁₁		S ₂₁		S ₁₂		S ₂₂	
	Magnitude (ratio)	Angle (deg)	Magnitude (ratio)	Angle (deg)	Magnitude (ratio)	Angle (deg)	Magnitude (ratio)	Angle (deg)
50	0.987	-4.169	2.87	175.5	0.0008	83.82	0.992	-1.42
100	0.983	-8.109	2.95	171.14	0.0015	82.08	0.992	-2.86
200	0.976	-15.97	2.93	162.44	0.0028	77.50	0.990	-5.66
300	0.966	-23.844	2.89	153.77	0.0041	73.45	0.989	-8.49
400	0.952	-31.575	2.84	145.23	0.0053	69.42	0.986	-11.28
500	0.935	-35.225	2.78	136.82	0.0063	65.72	0.984	-14.03
600	0.917	-46.678	2.72	128.50	0.0072	61.48	0.981	-16.80
700	0.898	-54.094	2.65	120.44	0.0079	58.05	0.977	-19.55
800	0.876	-61.205	2.57	112.33	0.0084	52.74	0.974	-22.32
900	0.852	-68.299	2.49	104.32	0.0089	48.61	0.970	-25.10
1000	0.826	-75.321	2.41	96.42	0.0091	43.86	0.967	-27.88

8.2 Dynamic characteristics for amplifier B

Table 10: Dynamic characteristics for amplifier B

Common source; $T_{amb} = 25\text{ °C}$; $V_{G2-S} = 4\text{ V}$; $V_{DS} = 5\text{ V}$; $I_D = 14\text{ mA}$. [1]

Symbol	Parameter	Conditions	Min	Typ	Max	Unit
$ y_{fs} $	forward transfer admittance	$T_j = 25\text{ °C}$	26	31	41	mS
$C_{iss(G1)}$	input capacitance at gate1	$f = 100\text{ MHz}$	-	1.8	2.3	pF
$C_{iss(G2)}$	input capacitance at gate2	$f = 1\text{ MHz}$	-	3.5	-	pF
C_{oss}	output capacitance	$f = 100\text{ MHz}$	-	0.8	-	pF
C_{rss}	reverse transfer capacitance	$f = 100\text{ MHz}$	-	20	-	fF
G_{tr}	power gain	$B_S = B_{S(opt)}$; $B_L = B_{L(opt)}$				
		$f = 200\text{ MHz}$; $G_S = 2\text{ mS}$; $G_L = 0.5\text{ mS}$	30	34	38	dB
		$f = 400\text{ MHz}$; $G_S = 2\text{ mS}$; $G_L = 1\text{ mS}$	27	31	35	dB
		$f = 800\text{ MHz}$; $G_S = 3.3\text{ mS}$; $G_L = 1\text{ mS}$	23	27	31	dB
NF	noise figure	$f = 11\text{ MHz}$; $G_S = 20\text{ mS}$; $B_S = 0\text{ S}$	-	5	-	dB
		$f = 400\text{ MHz}$; $Y_S = Y_{S(opt)}$	-	1.3	-	dB
		$f = 800\text{ MHz}$; $Y_S = Y_{S(opt)}$	-	1.4	-	dB
Xmod	cross-modulation	input level for $k = 1\%$; $f_w = 50\text{ MHz}$; $f_{unw} = 60\text{ MHz}$ [2]				
		at 0 dB AGC	90	-	-	dB μ V
		at 10 dB AGC	-	88	-	dB μ V
		at 20 dB AGC	-	94	-	dB μ V
		at 40 dB AGC	100	103	-	dB μ V

[1] For the MOSFET not in use: $V_{G1-S(A)} = 0\text{ V}$; $V_{DS(A)} = 0\text{ V}$.[2] Measured in [Figure 30](#) test circuit.

8.2.1 Graphs for amplifier B

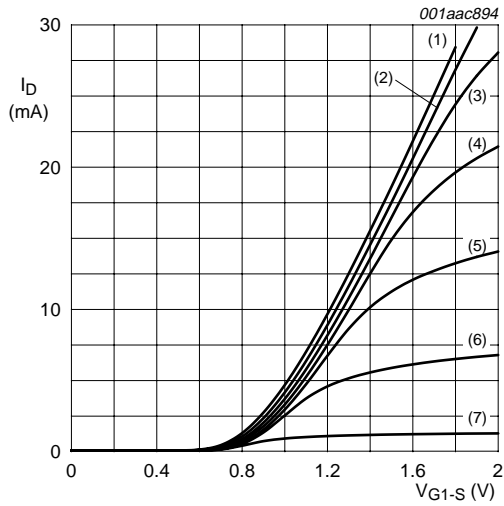

- (1) $V_{G2-S} = 4 \text{ V.}$
 - (2) $V_{G2-S} = 3.5 \text{ V.}$
 - (3) $V_{G2-S} = 3 \text{ V.}$
 - (4) $V_{G2-S} = 2.5 \text{ V.}$
 - (5) $V_{G2-S} = 2 \text{ V.}$
 - (6) $V_{G2-S} = 1.5 \text{ V.}$
 - (7) $V_{G2-S} = 1 \text{ V.}$
- $V_{DS(B)} = 5 \text{ V; } V_{G1-S(A)} = 0 \text{ V; } T_j = 25 \text{ }^\circ\text{C.}$

Fig 16. Amplifier B: transfer characteristics; typical values

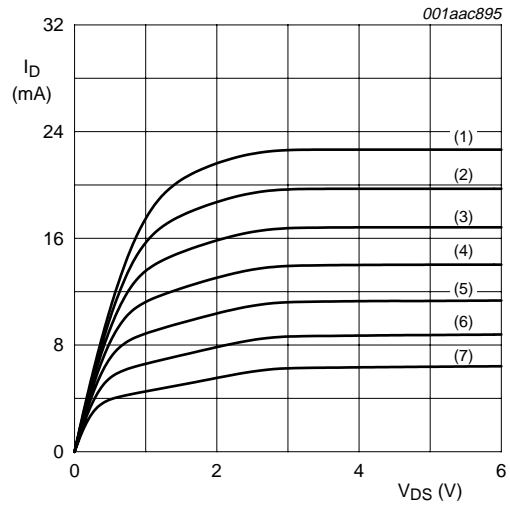

- (1) $V_{G1-S(B)} = 1.7 \text{ V.}$
 - (2) $V_{G1-S(B)} = 1.6 \text{ V.}$
 - (3) $V_{G1-S(B)} = 1.5 \text{ V.}$
 - (4) $V_{G1-S(B)} = 1.4 \text{ V.}$
 - (5) $V_{G1-S(B)} = 1.3 \text{ V.}$
 - (6) $V_{G1-S(B)} = 1.2 \text{ V.}$
 - (7) $V_{G1-S(B)} = 1.1 \text{ V.}$
- $V_{G2-S} = 4 \text{ V; } V_{G1-S(A)} = 0 \text{ V; } T_j = 25 \text{ }^\circ\text{C.}$

Fig 17. Amplifier B: output characteristics; typical values

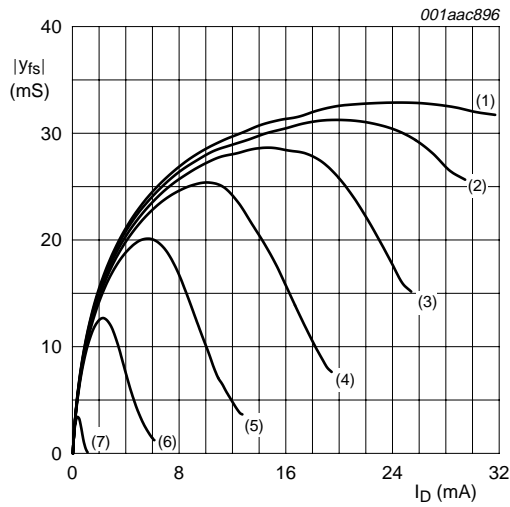

- (1) $V_{G2-S} = 4 \text{ V}$.
 - (2) $V_{G2-S} = 3.5 \text{ V}$.
 - (3) $V_{G2-S} = 3 \text{ V}$.
 - (4) $V_{G2-S} = 2.5 \text{ V}$.
 - (5) $V_{G2-S} = 2 \text{ V}$.
 - (6) $V_{G2-S} = 1.5 \text{ V}$.
 - (7) $V_{G2-S} = 1 \text{ V}$.
- $V_{DS(B)} = 5 \text{ V}; V_{G1-S(A)} = 0 \text{ V}; T_j = 25 \text{ }^\circ\text{C}$.

Fig 18. Amplifier B: forward transfer admittance as a function of drain current; typical values

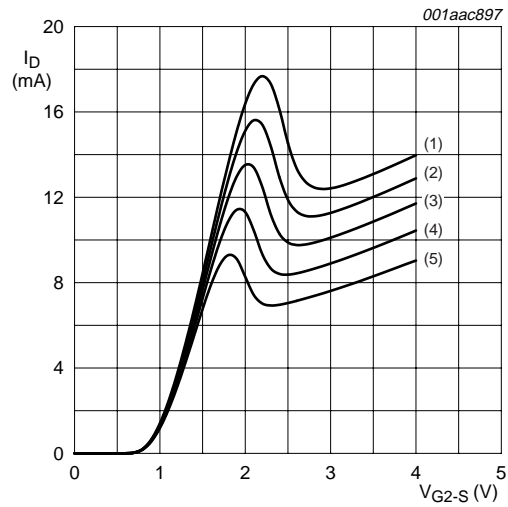

- (1) $V_{DS} = 5 \text{ V}$.
 - (2) $V_{DS} = 4.5 \text{ V}$.
 - (3) $V_{DS} = 4 \text{ V}$.
 - (4) $V_{DS} = 3.5 \text{ V}$.
 - (5) $V_{DS} = 3 \text{ V}$.
- $V_{G1-S(A)} = 0 \text{ V}; T_j = 25 \text{ }^\circ\text{C}$.

Fig 19. Amplifier B: drain current as function of gate2 voltage; typical values

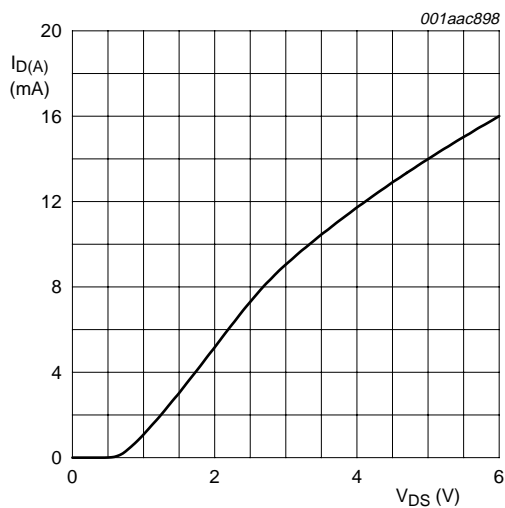

$V_{DS(B)} = 5 \text{ V}; V_{G1-S(A)} = 0 \text{ V}; T_j = 25 \text{ }^\circ\text{C}$.

Fig 20. Amplifier B: drain current as a function of drain source voltage; typical values

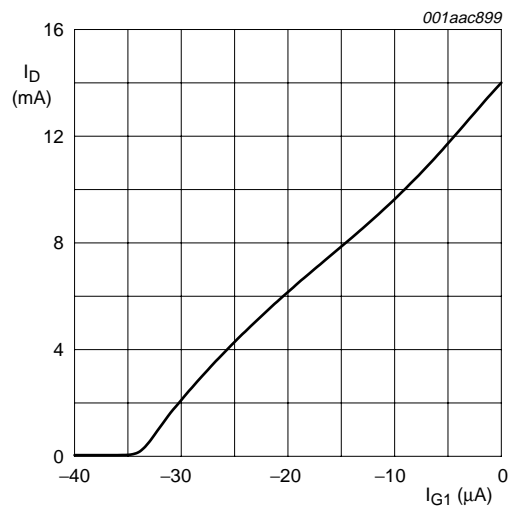

$V_{DS(B)} = 5 \text{ V}; V_{G2-S} = 4 \text{ V}; V_{G1-S(A)} = 0 \text{ V}; T_j = 25 \text{ }^\circ\text{C}$.

Fig 21. Amplifier B: drain current as a function of gate1 current; typical values

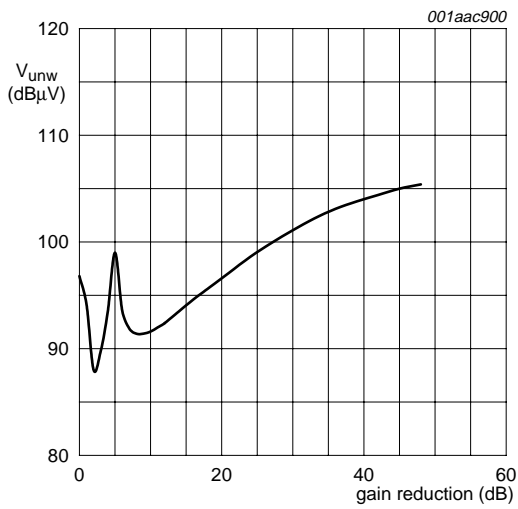

$V_{DS(B)} = 5\text{ V}$; $V_{GG} = 5\text{ V}$; $V_{DS(A)} = V_{G1-S(A)} = 0\text{ V}$;
 $R_{G1(B)} = 150\text{ k}\Omega$ (connected to V_{GG}); $f_w = 50\text{ MHz}$;
 $f_{unw} = 60\text{ MHz}$; $T_{amb} = 25\text{ }^\circ\text{C}$; see [Figure 30](#).

Fig 22. Amplifier B: unwanted voltage for 1 % cross-modulation as a function of gain reduction; typical values

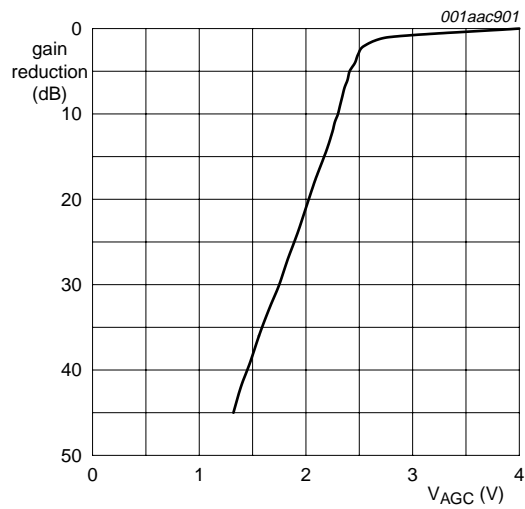

$V_{DS(B)} = 5\text{ V}$; $V_{GG} = 5\text{ V}$; $V_{DS(A)} = V_{G1-S(A)} = 0\text{ V}$;
 $R_{G1(B)} = 150\text{ k}\Omega$ (connected to V_{GG}); $f = 50\text{ MHz}$;
 $T_{amb} = 25\text{ }^\circ\text{C}$; see [Figure 30](#).

Fig 23. Amplifier B: typical gain reduction as a function of AGC voltage; typical values

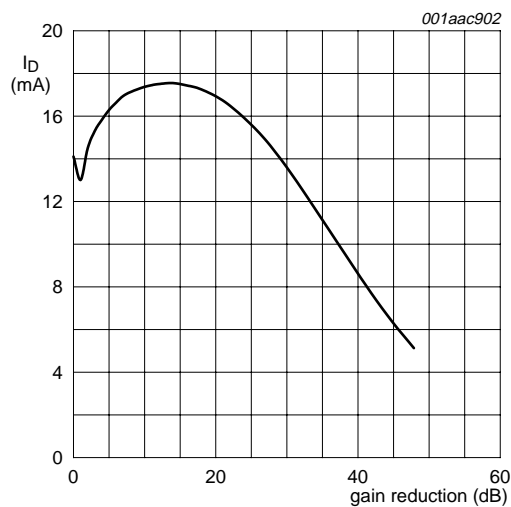

$V_{DS(B)} = 5\text{ V}$; $V_{GG} = 5\text{ V}$; $V_{DS(A)} = V_{G1-S(A)} = 0\text{ V}$; $R_{G1(B)} = 150\text{ k}\Omega$ (connected to V_{GG}); $f = 50\text{ MHz}$; $T_{amb} = 25\text{ }^\circ\text{C}$; see [Figure 30](#).

Fig 24. Amplifier B: drain current as a function of gain reduction; typical values

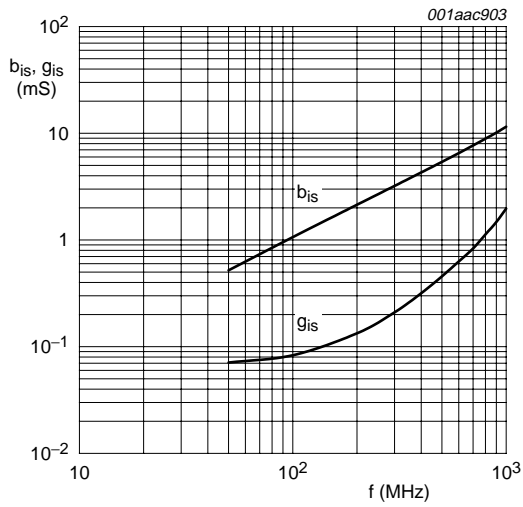

$V_{DS(B)} = 5\text{ V}; V_{G2-S} = 4\text{ V}; V_{DS(A)} = V_{G1-S(A)} = 0\text{ V}; I_{D(B)} = 14\text{ mA}.$

Fig 25. Amplifier B: input admittance as a function of frequency; typical values

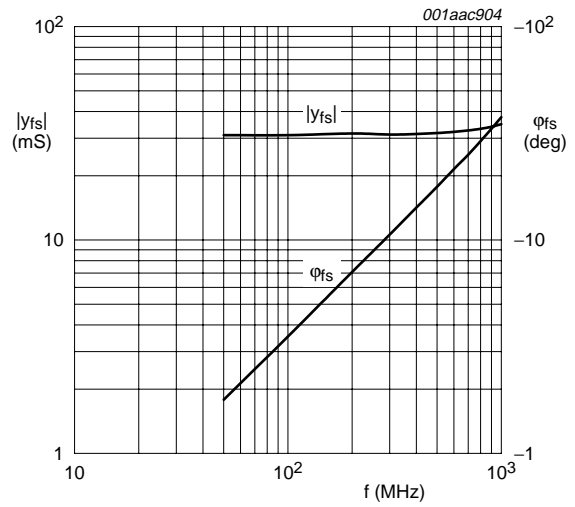

$V_{DS(B)} = 5\text{ V}; V_{G2-S} = 4\text{ V}; V_{DS(A)} = V_{G1-S(A)} = 0\text{ V}; I_{D(B)} = 14\text{ mA}.$

Fig 26. Amplifier B: forward transfer admittance and phase as a function of frequency; typical values

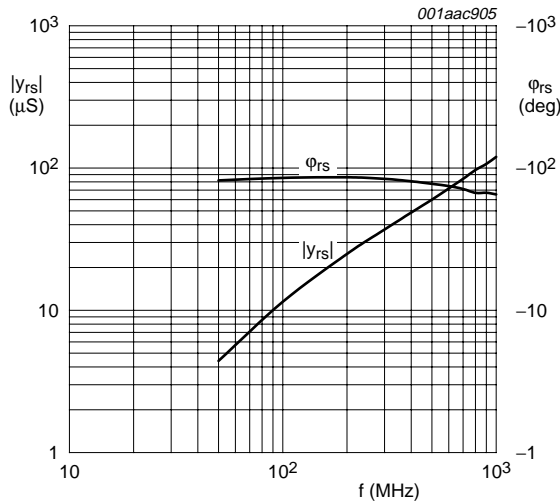

$V_{DS(B)} = 5\text{ V}; V_{G2-S} = 4\text{ V}; V_{DS(A)} = V_{G1-S(A)} = 0\text{ V}; I_{D(B)} = 14\text{ mA}.$

Fig 27. Amplifier B: reverse transfer admittance and phase as a function of frequency; typical values

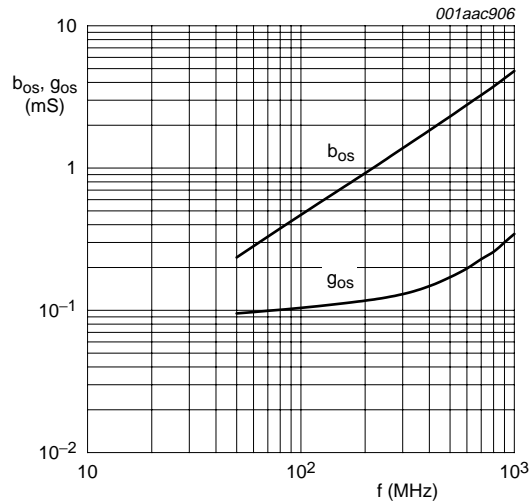

$V_{DS(B)} = 5\text{ V}; V_{G2-S} = 4\text{ V}; V_{DS(A)} = V_{G1-S(A)} = 0\text{ V}; I_{D(B)} = 14\text{ mA}.$

Fig 28. Amplifier B: output admittance as a function of frequency; typical values

8.2.2 Scattering parameters for amplifier B

Table 11: Scattering parameters for amplifier B

$V_{DS(B)} = 5\text{ V}$; $V_{G2-S} = 4\text{ V}$; $I_{D(B)} = 14\text{ mA}$; $V_{DS(A)} = 0\text{ V}$; $V_{G1-S(A)} = 0\text{ V}$; $T_{amb} = 25\text{ °C}$; typical values.

f (MHz)	S ₁₁		S ₂₁		S ₁₂		S ₂₂	
	Magnitude (ratio)	Angle (deg)	Magnitude (ratio)	Angle (deg)	Magnitude (ratio)	Angle (deg)	Magnitude (ratio)	Angle (deg)
50	0.993	-3.018	3.07	176.04	0.0004	95.97	0.991	-1.39
100	0.992	-6.186	3.07	172.05	0.0011	90.33	0.990	-2.79
200	0.987	-12.43	3.09	164.13	0.0024	85.03	0.988	-5.49
300	0.979	-18.60	3.02	156.28	0.0036	82.94	0.986	-8.21
400	0.969	-24.62	2.99	148.48	0.0046	81.97	0.983	-10.91
500	0.957	-30.72	2.95	140.69	0.0056	81.03	0.980	-13.63
600	0.943	-36.71	2.90	132.87	0.0065	79.77	0.977	-16.40
700	0.927	-42.77	2.86	125.21	0.0074	79.04	0.973	-19.13
800	0.907	-48.91	2.79	117.22	0.0082	79.42	0.969	-21.93
900	0.885	-54.77	2.736	109.29	0.0086	75.47	0.964	-24.85
1000	0.858	-61.01	2.675	101.18	0.0092	73.48	0.958	-27.75

9. Test information

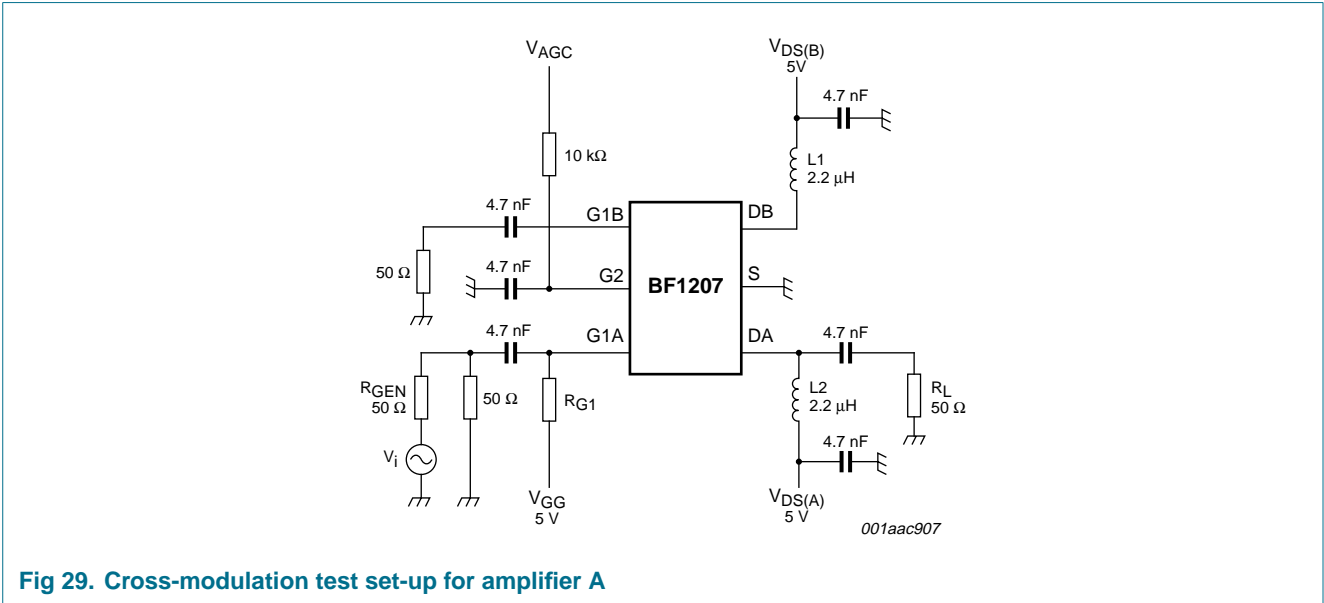

Fig 29. Cross-modulation test set-up for amplifier A

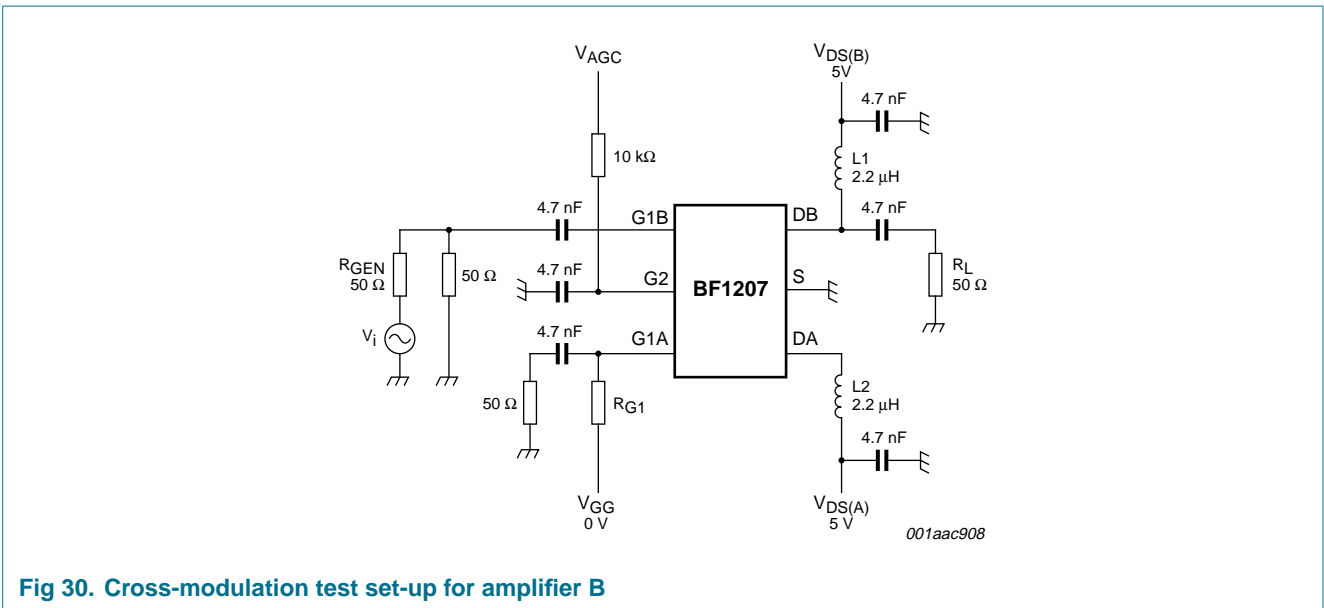

Fig 30. Cross-modulation test set-up for amplifier B

10. Package outline

Plastic surface mounted package; 6 leads

SOT363

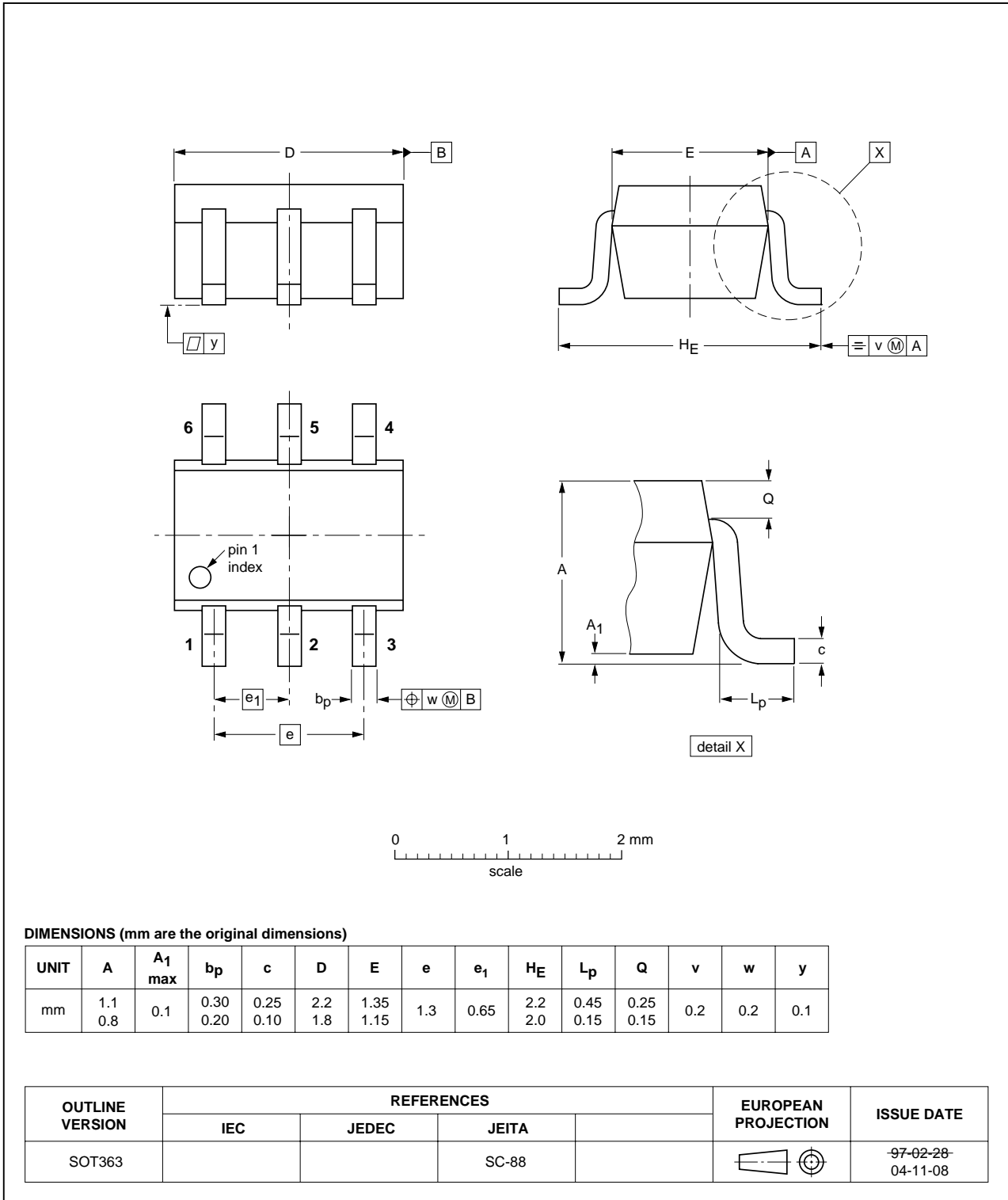

Fig 31. Package outline SOT363

11. Revision history

Table 12: Revision history

Document ID	Release date	Data sheet status	Change notice	Doc. number	Supersedes
BF1207_1	20050728	Product data sheet	-	9397 750 14955	-

12. Data sheet status

Level	Data sheet status ^[1]	Product status ^[2] ^[3]	Definition
I	Objective data	Development	This data sheet contains data from the objective specification for product development. Philips Semiconductors reserves the right to change the specification in any manner without notice.
II	Preliminary data	Qualification	This data sheet contains data from the preliminary specification. Supplementary data will be published at a later date. Philips Semiconductors reserves the right to change the specification without notice, in order to improve the design and supply the best possible product.
III	Product data	Production	This data sheet contains data from the product specification. Philips Semiconductors reserves the right to make changes at any time in order to improve the design, manufacturing and supply. Relevant changes will be communicated via a Customer Product/Process Change Notification (CPCN).

[1] Please consult the most recently issued data sheet before initiating or completing a design.

[2] The product status of the device(s) described in this data sheet may have changed since this data sheet was published. The latest information is available on the Internet at URL <http://www.semiconductors.philips.com>.

[3] For data sheets describing multiple type numbers, the highest-level product status determines the data sheet status.

13. Definitions

Short-form specification — The data in a short-form specification is extracted from a full data sheet with the same type number and title. For detailed information see the relevant data sheet or data handbook.

Limiting values definition — Limiting values given are in accordance with the Absolute Maximum Rating System (IEC 60134). Stress above one or more of the limiting values may cause permanent damage to the device. These are stress ratings only and operation of the device at these or at any other conditions above those given in the Characteristics sections of the specification is not implied. Exposure to limiting values for extended periods may affect device reliability.

Application information — Applications that are described herein for any of these products are for illustrative purposes only. Philips Semiconductors make no representation or warranty that such applications will be suitable for the specified use without further testing or modification.

14. Disclaimers

Life support — These products are not designed for use in life support appliances, devices, or systems where malfunction of these products can reasonably be expected to result in personal injury. Philips Semiconductors

16. Contact information

For additional information, please visit: <http://www.semiconductors.philips.com>

For sales office addresses, send an email to: sales.addresses@www.semiconductors.philips.com

customers using or selling these products for use in such applications do so at their own risk and agree to fully indemnify Philips Semiconductors for any damages resulting from such application.

Right to make changes — Philips Semiconductors reserves the right to make changes in the products - including circuits, standard cells, and/or software - described or contained herein in order to improve design and/or performance. When the product is in full production (status 'Production'), relevant changes will be communicated via a Customer Product/Process Change Notification (CPCN). Philips Semiconductors assumes no responsibility or liability for the use of any of these products, conveys no license or title under any patent, copyright, or mask work right to these products, and makes no representations or warranties that these products are free from patent, copyright, or mask work right infringement, unless otherwise specified.

15. Trademarks

Notice — All referenced brands, product names, service names and trademarks are the property of their respective owners.

17. Contents

1	Product profile	1
1.1	General description	1
1.2	Features	1
1.3	Applications	1
1.4	Quick reference data	2
2	Pinning information	2
3	Ordering information	3
4	Marking	3
5	Limiting values	3
6	Thermal characteristics	4
7	Static characteristics	4
8	Dynamic characteristics	6
8.1	Dynamic characteristics for amplifier A	6
8.1.1	Graphs for amplifier A	7
8.1.2	Scattering parameters for amplifier A	11
8.2	Dynamic characteristics for amplifier B	12
8.2.1	Graphs for amplifier B	13
8.2.2	Scattering parameters for amplifier B	17
9	Test information	18
10	Package outline	19
11	Revision history	20
12	Data sheet status	21
13	Definitions	21
14	Disclaimers	21
15	Trademarks	21
16	Contact information	21



© Koninklijke Philips Electronics N.V. 2005



All rights are reserved. Reproduction in whole or in part is prohibited without the prior written consent of the copyright owner. The information presented in this document does not form part of any quotation or contract, is believed to be accurate and reliable and may be changed without notice. No liability will be accepted by the publisher for any consequence of its use. Publication thereof does not convey nor imply any license under patent- or other industrial or intellectual property rights.

Date of release: 28 July 2005
Document number: 9397 750 14955

Published in The Netherlands

Looking for pricing, stock, or lifecycle information?

Click below to explore more details on WIN SOURCE:

-  [View BF1207 on WIN SOURCE](#)
-  [NXP / Nexperia Information](#)

Optimize Your Supply Chain with WIN SOURCE Solutions

-  Global Sourcing Solution
-  Obsolete Management
-  Cost Control Management
-  Shortage Management
-  Alternative Solution
-  Excess Inventory Management